

| CHAPTER 1 - GENERAL HOUSEKEEPING | | | |
|---|--|----------------|-------------|
| SUBHEADING | SECTION TITLE | CHAPTER | PAGE |
| | SCDOT Contacts | 1 | 3 |
| | SCDOT Concrete Technician Certification Class Schedule | 1 | 4 |
| Presentation | Where To Find What You Need on the Internet | 1 | 5 |
| CHAPTER 2 - CONCRETE MATERIALS 101 | | | |
| SUBHEADING | SECTION TITLE | CHAPTER | PAGE |
| Presentation | Concrete 101 | 2 | 3 |
| 2 | Concrete Materials 101 | 2 | 24 |
| 2.1 | What is Concrete? | 2 | 24 |
| 2.1.1 | Portland Cement and Other Cementitious Materials | 2 | 25 |
| | Cements- General Information | 2 | 25 |
| | Properties of PC | 2 | 26 |
| | Admixtures for PC Concrete | 2 | 27 |
| 2.1.2 | Aggregate | 2 | 29 |
| 2.1.3 | Water | 2 | 29 |
| 2.1.4 | Hydration | 2 | 30 |
| 2.2 | What is Ready Mixed Concrete? | 2 | 30 |
| | Principal Requirements for PC Concrete | 2 | 30 |
| 2.2.1 | Ordering Information | 2 | 30 |
| 2.2.1.1 | Quality | 2 | 31 |
| 2.2.1.2 | Quantity | 2 | 31 |
| 2.3 | Production of Ready Mixed Concrete | 2 | 32 |
| 2.3.1 | Proportioning | 2 | 32 |
| 2.3.2 | Production | 2 | 32 |
| 2.3.2.1 | Transit Mixed Concrete | 2 | 32 |
| 2.3.2.2 | Shrink Mixed Concrete | 2 | 33 |
| 2.3.2.3 | Central Mixed Concrete | 2 | 33 |
| 2.3.2.4 | Mobile Volumetric Proportioning Plants (Mix Mobile) | 2 | 34 |
| 2.3.2.5 | Batch Plant Styles | 2 | 34 |
| 2.3.3 | Delivery | 2 | 35 |
| 2.3.3.1 | The Truck Mixer | 2 | 35 |
| 2.3.4 | Inspection and Testing | 2 | 35 |
| | Strength of PC Concrete - General | 2 | 36 |
| | Compressive Strength - General | 2 | 36 |
| 2.4 | Inspecting a Ready Mix Plant | 2 | 36 |
| CHAPTER 3 - QUALIFIED PRODUCT LISTINGS | | | |
| SUBHEADING | SECTION TITLE | CHAPTER | PAGE |
| Presentation | QPL & QPP | 3 | 2 |
| Product #1 | Fine Aggregate | 3 | 9 |
| Product #2 | Coarse Aggregate | 3 | 13 |
| Product #3 | Fly Ash | 3 | 16 |
| Product #5 | Air Entraining and Chemical Admixtures for Concrete | 3 | 18 |
| Product #6 | Portland Cement and Slag | 3 | 20 |
| Product #7 | Surface Coatings | 3 | 22 |
| Product #10 | Bridge Deck Waterproofing Membrane Type 1 | 3 | 24 |
| Product #11 | Cold Applied Sealants for Bridge Joints | 3 | 25 |
| Product #18 | Type IS Portland Blast-furnace Slag Cement | 3 | 27 |
| Product #22 | Rapid Patch Material for Concrete Pavement | 3 | 28 |
| Product #28 | Ready Mix Concrete Plants | 3 | 30 |
| Product #32 | Stabilizer Agents for Mixer Drum Wash Water | 3 | 32 |
| Product #33 | Curing Compounds for Concrete Structures | 3 | 35 |
| Product #53 | Corrosion Inhibitors for Concrete | 3 | 37 |

| SUBHEADING | CHAPTER 3 - QUALIFIED PRODUCT LISTINGS (Continued) | CHAPTER | PAGE |
|---|---|----------------|-------------|
| Product #54 | Temporary Concrete Barrier Producers | 3 | 39 |
| Product #60 | Reinforcing Steel | 3 | 40 |
| Product #69 | Reinforced Concrete Pipe | 3 | 43 |
| Product #73 | Mechanical Couplers for Reinforcing Steel | 3 | 46 |
| Product #81 | Preformed Rubber Joint Filler | 3 | 48 |
| Product #86 | Type IL Portland-Limestone Cement | 3 | 49 |
| CHAPTER 4 - STANDARD SPECIFICATIONS: SECTION 701 | | | |
| SUBHEADING | SECTION TITLE | CHAPTER | PAGE |
| Presentation | SCDOT PCC Specifications | 4 | 3 |
| Section 701 | Portland Cement and Portland Cement Concrete | 4 | 14 |
| 701.1 | Description | 4 | 14 |
| 701.1.1 | Classes of Concrete | 4 | 14 |
| 701.2 | Materials | 4 | 14 |
| 701.2.1 | Portland Cement | 4 | 14 |
| 701.2.1.1 | General | 4 | 14 |
| 701.2.2 | Fly Ash | 4 | 15 |
| 701.2.3 | Water Granulated Blast-Furnace Slag | 4 | 15 |
| 701.2.4 | Silica Fume | 4 | 16 |
| 701.2.5 | Air Entrained Concrete | 4 | 16 |
| 701.2.5.1 | Air-Entrained Admixtures | 4 | 16 |
| 701.2.6 | Accelerating, Retarding, and Water-Reducing Admixtures | 4 | 17 |
| 701.2.7 | Corrosion Inhibitor | 4 | 17 |
| 701.2.8 | Calcium Chloride | 4 | 17 |
| 701.2.9 | Fine Aggregate for Portland Cement Concrete | 4 | 17 |
| 701.2.9.1 | General | 4 | 17 |
| 701.2.9.2 | Natural Sand | 4 | 17 |
| 701.2.9.3 | Manufactured Sand | 4 | 18 |
| 701.2.9.4 | Mixtures of Sand | 4 | 18 |
| 701.2.9.5 | Organic Impurities | 4 | 18 |
| 701.2.9.6 | Soundness | 4 | 18 |
| 701.2.9.7 | Approved Sources | 4 | 18 |
| 701.2.9.8 | Gradation of Fine Aggregate | 4 | 18 |
| 701.2.10 | Coarse Aggregate | 4 | 18 |
| 701.2.10.1 | General | 4 | 18 |
| 701.2.10.2 | Slag | 4 | 19 |
| 701.2.10.3 | Approved Sources | 4 | 19 |
| 701.2.10.4 | Gradation of Coarse Aggregate | 4 | 19 |
| 701.2.11 | Water | 4 | 19 |
| 701.2.11.1 | General | 4 | 19 |
| 701.2.11.2 | Water from a Public Water Supply | 4 | 20 |
| 701.2.11.3 | Water from Sources Other than a Public Water Supply | 4 | 20 |
| 701.2.12 | Concrete Mix Design | 4 | 21 |
| 701.2.12.1 | General | 4 | 21 |
| 701.2.12.2 | Structural Concrete Table | 4 | 22 |
| 701.2.12.3 | Structural Concrete Table Notes | 4 | 24 |
| 701.2.12.3.1 | Entrained Air and Slump Tests | 4 | 27 |
| 701.2.12.4 | Non-conforming Concrete | 4 | 28 |
| 701.2.12.4.1 | Price Reduction | 4 | 28 |
| 701.2.12.4.2 | Procedure for Testing Non-conforming Concrete | 4 | 28 |
| 701.2.12.4.2.1 | Limits of Questionable Concrete | 4 | 28 |
| 701.2.12.4.2.2 | Obtaining Cores | 4 | 28 |
| 701.2.12.4.2.3 | Conditioning and Testing Cores | 4 | 29 |

| CHAPTER 4 - STANDARD SPECIFICATIONS (Continued) | | | |
|---|---|----------------|-------------|
| SUBHEADING | SECTION TITLE | CHAPTER | PAGE |
| 701.2.12.4.2.4 | Acceptance of Concrete | 4 | 29 |
| 701.2.12.5 | Changes in Mix Design | 4 | 29 |
| 701.3 | Equipment | 4 | 29 |
| 701.3.1 | Equipment, Inspection, and Approval | 4 | 29 |
| 701.3.2 | Weighing Equipment | 4 | 30 |
| 701.3.3 | Central Mixing Plant | 4 | 30 |
| 701.3.4 | Truck Mixers | 4 | 31 |
| 704.4 | Construction | 4 | 32 |
| 701.4.1 | Care and Storage of Concrete Aggregates | 4 | 32 |
| 701.4.2 | Storage of Cement | 4 | 33 |
| 701.4.3 | Measuring Materials | 4 | 33 |
| 701.4.3.1 | Portland Cement | 4 | 33 |
| 701.4.3.2 | Water | 4 | 33 |
| 701.4.3.3 | Fine and Coarse Aggregate | 4 | 33 |
| 701.4.3.4 | Admixtures | 4 | 33 |
| 701.4.4 | Concrete Batching and Mixing | 4 | 34 |
| 701.4.4.1 | General | 4 | 34 |
| 701.4.4.2 | Batching and Mixing in Cold Weather | 4 | 34 |
| 701.4.4.3 | Batching and Mixing in Hot Weather | 4 | 35 |
| 701.4.4.4 | Central Plant Mixing | 4 | 35 |
| 701.4.4.5 | Truck Mixing | 4 | 35 |
| 701.4.4.6 | Wash Water Stabilizers | 4 | 36 |
| 701.4.4.7 | Mobile Concrete Mixing Plants | 4 | 36 |
| 701.4.5 | Consistency | 4 | 36 |
| 701.4.6 | Slump | 4 | 36 |
| 701.4.7 | Water Reducers | 4 | 36 |
| 701.4.8 | Water Reducer-Retarders | 4 | 37 |
| 701.4.9 | Fly Ash and Water-Granulated Blast-Furnace Slag | 4 | 37 |
| 701.5 | Measurement | 4 | 38 |
| 701.6 | Payment | 4 | 38 |
| Table | A-4 Gradation of Course Aggregates | 4 | 40 |
| Table | A-5 Gradation of Fine Aggregates | 4 | 41 |
| Figure | A-7 Nomograph for Determining Rate of Evaporation | 4 | 42 |
| CHAPTER 5 - SUPPLEMENTAL SPECIFICATIONS, DEPARTMENT MEMOS, AND CHANGES | | | |
| 4/8/2008 | Surface Smoothness of Bridge Decks and Approach Slabs | 5 | 3 |
| 4/5/2010 | Concrete Batching and Mixing | 5 | 5 |
| 4/1/2013 | Concrete Structures - Preformed Joint Filler | 5 | 6 |
| 5/5/2014 | Portland Cement and Portland Cement Concrete | 5 | 7 |
| 8/1/2014 | Class 5000 Structural Concrete | 5 | 8 |
| 2/1/2015 | Concrete Entrained Air and Slump Properties | 5 | 9 |
| 8/3/2015 | Section 703 Reinforcing Steel | 5 | 10 |
| 7/1/2018 | Concrete Placement in Cold and Hot Weather | 5 | 15 |
| 7/1/2018 | Concrete Batching & Mixing in Cold and Hot Weather | 5 | 17 |
| 1/1/2019 | Concrete Structures – Preformed Joint Fillers | 5 | 19 |
| 7/1/2019 | Fine and Coarse Aggregate | 5 | 20 |
| 7/1/2019 | Volumetric Concrete Mixers | 5 | 21 |
| 4/20/2020 | COVID-19 Memorandum | 5 | 23 |
| 7/1/2020 | Reinforcing Steel | 5 | 25 |
| 1/1/2021 | Concrete Mix Design | 5 | 31 |
| 1/1/2021 | Falsework/Forming Systems | 5 | 33 |
| 7/1/2021 | Fine and Coarse Aggregates | 5 | 35 |

| CHAPTER 5 - SUPPLEMENTAL SPECIFICATIONS, DEPARTMENT MEMOS, AND CHANGES (Continued) | | | |
|---|---|----------------|-------------|
| DOC DATE | SECTION TITLE | CHAPTER | PAGE |
| 7/1/2021 | Grooved Surface Finish | 5 | 36 |
| 7/1/2021 | Removal of Falsework and Forms | 5 | 37 |
| 7/1/2021 | High-Tensile-Strength Seven-Wire Strand | 5 | 38 |
| 1/1/2022 | Mass Concrete Placement | 5 | 39 |
| CHAPTER 6 - MOISTURE CORRECTION AND CONCRETE BATCHING | | | |
| SUBHEADING | SECTION TITLE | CHAPTER | PAGE |
| 6.1 | Moisture Correction for Fine and Coarse Aggregates using the Dry Method | 6 | 3 |
| Presentation | Aggregate Moisture Corrections & Concrete Batching | 6 | 3 |
| Tutorial | Mix Development Tutorial- Problem Statement(Class 4000 w/ Fly Ash) | 6 | 11 |
| Example Q1 | Class 2500 PCC with 5% Fly Ash Replacement | 6 | 35 |
| Example Q2 | Class 3000 PCC with 6% Fly Ash Replacement | 6 | 37 |
| Example Q3 | Class 7000 PCC with 8% Fly Ash Replacement | 6 | 39 |
| Example Q4 | Class 4000 PCC with 20% Fly Ash Replacement | 6 | 41 |
| Example Q5 | Class 6500 PCC | 6 | 43 |
| Example Q6 | Class 5000 Concrete with 10% Fly Ash Replacement | 6 | 45 |
| Answer Q1 | Class 2500 PCC with 5% Fly Ash Replacement | 6 | 47 |
| Answer Q2 | Class 3000 PCC with 6% Fly Ash Replacement | 6 | 49 |
| Answer Q3 | Class 7000 PCC with 8% Fly Ash Replacement | 6 | 51 |
| Answer Q4 | Class 4000 PCC with 20% Fly Ash Replacement | 6 | 53 |
| Answer Q5 | Class 6500 PCC | 6 | 55 |
| Answer Q6 | Class 5000 PCC with 10% Fly Ash Replacement | 6 | 57 |
| | Blank Concrete Batching Forms | 6 | 59 |
| CHAPTER 7 - FORM 700.04 | | | |
| SUBHEADING | SECTION TITLE | CHAPTER | PAGE |
| Guidelines | Guidelines for Completing the SCDOT Form 700.04 | 7 | 3 |
| Presentation | Form 700.04 | 7 | 7 |
| Tutorial | Form 700.04 Example -- 30 cubic yards of Class 5000 | 7 | 23 |
| Example Q2 | Form 700.04 Example -- 8 cubic yards of Class 5000 | 7 | 91 |
| Example Q3 | Form 700.04 Example -- 3 cubic yards of Class 5000 | 7 | 93 |
| Example Q4 | Form 700.04 Example -- 9 cubic yards of Class 5000 | 7 | 95 |
| | Blank 700.04 Forms | 7 | 97 |
| Presentation | Aggregate Sampling | 7 | 117 |
| CHAPTER 8 - STANDARD SPECIFICATIONS: SECTION 702 | | | |
| SUBHEADING | SECTION TITLE | CHAPTER | PAGE |
| Presentation | Standard Specifications: 702 Concrete Structures | 8 | 3 |
| 702.1 | Description | 8 | 15 |
| 702.2 | Materials | 8 | 15 |
| 702.2.1 | Concrete | 8 | 15 |
| 702.2.2 | Expansion Joint Material | 8 | 15 |
| 702.2.2.1 | Preformed Joint Filler | 8 | 15 |
| 702.2.2.2 | Hot-Poured Elastic Filler | 8 | 15 |
| 702.2.2.3 | Elastomeric Compression Seals for Bridge Decks | 8 | 15 |
| 702.2.2.4 | Metal Expansion Plates | 8 | 16 |
| 702.2.2.5 | Roofing Felt | 8 | 16 |
| 702.2.2.6 | Copper Flashing | 8 | 16 |
| 702.2.2.7 | Plastic Waterstops | 8 | 16 |
| 702.2.2.8 | Pipes and Conduits | 8 | 16 |
| 702.2.2.9 | Cold Applied Elastic Filler | 8 | 16 |
| 702.2.2.10 | Bridge Deck Joint Strip Seals | 8 | 16 |
| 702.2.2.11 | Liquid Curing Compounds | 8 | 16 |
| 702.2.2.12 | Falsework | 8 | 17 |

| SUBHEADING | CHAPTER 8-STANDARD SPECIFICATIONS: SECTION 702 (Continued) | CHAPTER | PAGE |
|---------------|--|---------|------|
| 702.2.2.13 | Forms | 8 | 18 |
| 702.3 | Equipment | 8 | 18 |
| 702.3.1 | Vibrators | 8 | 18 |
| 702.3.2 | Tremie | 8 | 18 |
| 702.3.3 | Kettles for Heating Hot-Poured Elastic Filler | 8 | 18 |
| 702.3.4 | Curing Blankets | 8 | 19 |
| 702.4 | Construction | 8 | 19 |
| 702.4.1 | Falsework/Forming Systems | 8 | 19 |
| 702.4.1.1 | General | 8 | 19 |
| 702.4.1.2 | Design | 8 | 19 |
| 702.4.1.3 | Working Drawing Submittal | 8 | 20 |
| 702.4.1.4 | Inspection | 8 | 20 |
| 702.4.1.4.1 | General | 8 | 20 |
| 702.4.1.4.2 | Category I | 8 | 20 |
| 702.4.1.4.3 | Category II | 8 | 20 |
| 702.4.1.4.4 | Designated Inspector Qualifications | 8 | 20 |
| 702.4.1.4.5 | Responsibility | 8 | 21 |
| 702.4.1.5 | Wood Forms | 8 | 21 |
| 702.4.1.6 | Metal Forms | 8 | 21 |
| 702.4.1.7 | Stay-in-Place (SIP) Forms for Concrete Deck Slabs | 8 | 21 |
| 702.4.1.7.1 | Material for SIP Forms | 8 | 22 |
| 702.4.1.7.2 | Design of SIP Forms | 8 | 22 |
| 702.4.1.7.2.1 | Loads for SIP Forms | 8 | 22 |
| 702.4.1.7.2.2 | Deflection of SIP Forms | 8 | 22 |
| 702.4.1.7.2.3 | Span Length of SIP Forms | 8 | 22 |
| 702.4.1.7.2.4 | Design Properties of SIP Forms | 8 | 22 |
| 702.4.1.7.3 | Reinforcing Steel in SIP Forms | 8 | 22 |
| 702.4.1.7.4 | Lateral Bracing for SIP Forms | 8 | 22 |
| 702.4.1.7.5 | Longitudinal Deck Joints for SIP Forms | 8 | 22 |
| 702.4.1.7.6 | Welding of SIP Forms | 8 | 22 |
| 702.4.1.7.7 | Shop Plans for SIP Forms | 8 | 23 |
| 702.4.1.7.8 | Construction with SIP Forms | 8 | 23 |
| 702.4.1.7.9 | Placing Concrete in SIP Forms | 8 | 23 |
| 702.4.1.7.10 | Inspection of SIP Forms | 8 | 23 |
| 702.4.1.8 | Construction of Falsework/Forms Systems | 8 | 24 |
| 702.4.2 | Handling and Placing Concrete | 8 | 24 |
| 702.4.2.1 | General | 8 | 24 |
| 702.4.2.2 | Construction Joints | 8 | 26 |
| 702.4.2.3 | Pumping Concrete | 8 | 27 |
| 702.4.2.4 | Vibration of Concrete | 8 | 27 |
| 702.4.2.5 | Mass Concrete Placement | 8 | 27 |
| 702.4.2.6 | Depositing Concrete Underwater | 8 | 29 |
| 702.4.2.7 | Concrete Exposed to Tidal Water | 8 | 29 |
| 702.4.2.8 | Temperature Control | 8 | 29 |
| 702.4.2.8.1 | Concreting in Cold Weather | 8 | 29 |
| 702.4.2.8.2 | Concreting in Hot Weather | 8 | 29 |
| 702.4.2.8.3 | Responsibility for Satisfactory Results of Temperature Control | 8 | 30 |
| 702.4.3 | Setting Finished Grade of Concrete Bridge Deck Slabs | 8 | 30 |
| 702.4.3.1 | Setting Finished Grade When Covered with a Wearing Surface | 8 | 30 |
| 702.4.3.2 | Setting Finished Grade When Not Covered with a Wearing Surface | 8 | 30 |
| 702.4.4 | Concrete Curing | 8 | 32 |
| 702.4.4.1 | Curing of Bridge Decks | 8 | 32 |

| CHAPTER 8 - STANDARD SPECIFICATIONS: SECTION 702 (Continued) | | | |
|---|---|----------------|-------------|
| SUBHEADING | SECTION TITLE | CHAPTER | PAGE |
| 702.4.4.2 | Curing Structural Concrete Other than Bridge Decks | 8 | 32 |
| 702.4.5 | Removal of Falsework and Forms | 8 | 33 |
| 702.4.6 | Protecting and Loading Recently Placed Concrete | 8 | 34 |
| 702.4.7 | Initial Surface Finish | 8 | 35 |
| 702.4.8 | Repair of Concrete Surface Defects | 8 | 35 |
| 702.4.9 | Repair of Crack in Top Surface of Bridge Decks | 8 | 36 |
| 702.4.10 | Repair of Top Surface of Bridge Decks | 8 | 36 |
| 702.4.10.1 | Repair of Small Areas in Top Surface of Bridge Decks | 8 | 36 |
| 702.4.10.2 | Repair of Large Areas on the Top Surface of Bridge Decks | 8 | 37 |
| 702.4.11 | Final Finish of Exposed Concrete Surfaces Other than Bridge Decks | 8 | 38 |
| 702.4.11.1 | General | 8 | 38 |
| 702.4.11.2 | Surface Preparation for Finish Coat | 8 | 38 |
| 702.4.11.3 | Application of Final Finish Coating | 8 | 39 |
| 702.4.11.4 | Sprayed Final Finish | 8 | 39 |
| 702.4.11.5 | Brushed Final Finish | 8 | 40 |
| 702.4.12 | Limits of Initial and Final Finishes | 8 | 40 |
| 702.4.13 | Treatment of Horizontal Surfaces not Subject to Wear | 8 | 41 |
| 702.4.14 | Bridge Deck Rideability | 8 | 41 |
| 702.4.14.1 | Rideability When Contractor Provides Stakes, Lines and Grades | 8 | 41 |
| 702.4.14.2 | Rideability When the Department Provides Partial Lines and Grades | 8 | 41 |
| 702.4.15 | Grinding and Texturing Bridge Decks | 8 | 41 |
| 702.4.16 | Grooved Surface Finish | 8 | 42 |
| 702.4.17 | Joints | 8 | 43 |
| 702.4.17.1 | General | 8 | 43 |
| 702.4.17.2 | Open Joints | 8 | 43 |
| 702.4.17.3 | Sliding Joints | 8 | 43 |
| 702.4.17.3.1 | Roofing Felt | 8 | 43 |
| 702.4.17.3.2 | Metal Plates | 8 | 43 |
| 702.4.17.3.3 | Mortised Joints | 8 | 43 |
| 702.4.17.4 | Fixed Joints | 8 | 43 |
| 702.4.17.5 | Expansion Joints | 8 | 43 |
| 702.4.17.5.1 | General | 8 | 43 |
| 702.4.17.5.2 | Compression Seal Joints | 8 | 44 |
| 702.4.17.5.3 | Hot-Poured Elastic Filler Joints | 8 | 44 |
| 702.4.17.5.4 | Deck Joint Strip Seals | 8 | 44 |
| 702.4.17.6 | Special Expansion Joints | 8 | 44 |
| 702.4.18 | Encased or Supported Pipes and Conduits | 8 | 44 |
| 702.4.19 | Weep Holes and Drains | 8 | 44 |
| 702.4.19.1 | General | 8 | 44 |
| 702.4.19.2 | Weep Holes and French Drains for Box Culverts | 8 | 45 |
| 702.4.19.3 | Weep Holes and French Drains in Retaining Walls | 8 | 45 |
| 702.4.20 | Bridge Sidewalks and Curbs | 8 | 45 |
| 702.4.21 | Widening Existing Concrete Structures | 8 | 45 |
| 702.5 | Measurement | 8 | 46 |
| 702.6 | Payment | 8 | 47 |
| A-4 | Gradation of Coarse Aggregates | 8 | 48 |
| A-5 | Gradation of Fine Aggregates | 8 | 49 |
| A-6 | Aggregate Applications | 8 | 50 |
| A-7 | Nomograph for Determining Rate of Evaporation | 8 | 51 |

| SUBHEADING | CHAPTER 9 - STANDARD SPECIFICATIONS: SECTION 703 | CHAPTER | PAGE |
|--------------|---|---------|------|
| Presentation | Standard Specifications: 703 Reinforcing Steel | 9 | 3 |
| 703.1 | Description | 9 | 17 |
| 703.1.1 | General | 9 | 17 |
| 703.1.2 | Production of Iron and Steel Products on Federal Aid Projects | 9 | 17 |
| 703.2 | Materials | 9 | 17 |
| 703.2.1 | Reinforcing Bars | 9 | 17 |
| 703.2.2 | Wire and Wire Fabric | 9 | 17 |
| 703.2.3 | Galvanized Reinforcing Bars | 9 | 17 |
| 703.2.3.1 | Use and Production | 9 | 17 |
| 703.2.3.2 | Repair of Galvanized Reinforcing Steel | 9 | 17 |
| 703.2.3.2.1 | Shop Repair | 9 | 17 |
| 703.2.3.2.2 | Field Repair | 9 | 17 |
| 703.2.3.3 | Handling, Placing, and Fastening | 9 | 18 |
| 703.2.4 | Mechanical Couplers for Reinforcing Steel | 9 | 18 |
| 703.2.4.1 | General | 9 | 18 |
| 703.2.4.2 | Quality Control Manager | 9 | 18 |
| 703.2.4.3 | Material Information and Certification | 9 | 18 |
| 703.2.4.4 | Manufacturer's Quality Control Testing Facility and Reports | 9 | 19 |
| 703.2.4.4.1 | General | 9 | 19 |
| 703.2.4.4.2 | Facilities | 9 | 19 |
| 703.2.4.4.3 | Markings | 9 | 19 |
| 703.2.4.4.4 | Operators | 9 | 19 |
| 703.2.4.4.5 | Calibration | 9 | 19 |
| 703.2.4.4.6 | Test Reports | 9 | 19 |
| 703.2.4.5 | Quality Control (QC) Test Requirements | 9 | 19 |
| 703.2.4.6 | Quality Assurance (QA) Test Requirements | 9 | 20 |
| 703.2.4.7 | Handling and Storage | 9 | 20 |
| 703.2.5 | Ultimate Butt-Welded Splices (UBWS) | 9 | 20 |
| 703.2.5.1 | Material | 9 | 20 |
| 703.2.5.2 | Fabricator Pre-Job Test Requirements | 9 | 20 |
| 703.2.5.3 | Quality Assurance (QA) Test Requirements | 9 | 21 |
| 703.2.5.3.1 | General | 9 | 21 |
| 703.2.5.3.2 | Test Sample Requirements | 9 | 21 |
| 703.2.5.3.3 | Control Sample Requirements | 9 | 21 |
| 703.2.5.3.4 | Test Criteria | 9 | 22 |
| 703.2.5.4 | Corrective Action | 9 | 22 |
| 703.2.6 | Bar Supports | 9 | 23 |
| 703.2.6.1 | General | 9 | 23 |
| 703.2.6.2 | Wire Bar Supports | 9 | 23 |
| 703.2.6.3 | Plastic Bar Supports | 9 | 23 |
| 703.2.6.4 | Concrete Blocks | 9 | 24 |
| 703.3 | Equipment | 9 | 24 |
| 703.4 | Construction | 9 | 24 |
| 703.4.1 | Protection of Materials | 9 | 24 |
| 703.4.2 | Bending | 9 | 24 |
| 703.4.3 | Placing and Fastening | 9 | 24 |
| 703.4.4 | Splicing of Bars | 9 | 25 |
| 703.4.4.1 | General | 9 | 25 |
| 703.4.4.2 | Lapped Splices | 9 | 25 |
| 703.4.4.3 | Ultimate Welded Lap Splices | 9 | 25 |
| 703.4.4.4 | Ultimate Welded Butt Splices | 9 | 25 |
| 703.4.4.5 | Mechanical Couplers | 9 | 25 |

| CHAPTER 9 - STANDARD SPECIFICATIONS: SECTION 703 (Continued) | | | |
|---|---|----------------|-------------|
| SUBHEADING | SECTION TITLE | CHAPTER | PAGE |
| 703.5 | Measurement | 9 | 25 |
| 703.6 | Payment | 9 | 26 |
| | ASTM Standard Inch-pound Reinforcing Bars | 9 | 27 |
| | ASTM Standard Metric Reinforcing Bars | 9 | 28 |

| CHAPTER 10 - SCDOT CONSTRUCTION MANUAL | | | |
|---|--|----------------|-------------|
| SUBHEADING | SECTION 101 | CHAPTER | PAGE |
| Presentation | Construction Manual | 10 | 3 |
| 101.1 | Purpose & Organization of Construction Manual | 10 | 9 |
| 101.2 | SCDOT Organization and Personnel Considerations | 10 | 9 |
| 101.2.1 | Central Office | 10 | 9 |
| 101.2.1.1 | Executive Level | 10 | 9 |
| 101.2.1.2 | Program Manager | 10 | 9 |
| 101.2.1.3 | Construction Operations | 10 | 9 |
| 101.2.2 | District Office | 10 | 10 |
| 101.2.2.1 | District Engineering Administrator | 10 | 10 |
| Figure 101A | Organization of SCDOT Construction Operations | 10 | 11 |
| 101.2.2.2 | District Construction Engineer | 10 | 12 |
| 101.2.2.3 | District Asphalt Manager | 10 | 12 |
| 101.2.2.4 | Asphalt Plant Inspector | 10 | 13 |
| 101.2.3 | County Level | 10 | 13 |
| 101.2.3.1 | Resident Construction Engineer | 10 | 13 |
| 101.2.3.2 | SCDOT Inspector | 10 | 14 |
| 101.2.4 | Personnel Policy | 10 | 15 |
| 101.2.4.1 | Rules and Regulations | 10 | 15 |
| 101.2.4.2 | Integrity | 10 | 15 |
| 101.2.4.3 | Training and Certification | 10 | 15 |
| 101.2.4.4 | Intra-Department Cooperation | 10 | 15 |
| 101.2.4.5 | Public Relations | 10 | 16 |
| 101.2.5 | Safety | 10 | 16 |
| 101.2.5.1 | General | 10 | 16 |
| 101.2.5.2 | Safe Driving | 10 | 16 |
| 101.2.5.3 | Surveying | 10 | 16 |
| 101.2.5.4 | Medical Treatment | 10 | 17 |
| 101.2.5.5 | Safety Equipment | 10 | 17 |
| 101.2.5.6 | Nuclear Density Gauges | 10 | 17 |
| 101.2.5.6.1 | Nuclear Density Gauges -- General Guidelines | 10 | 17 |
| 101.2.5.6.2 | NDG-- Certification and Licensing Considerations | 10 | 18 |
| 101.2.5.6.3 | NDG-- Transporting and Storage Considerations | 10 | 18 |
| 101.2.5.6.4 | NDG-- Emergency Procedures | 10 | 18 |
| 101.3 | Project Development Considerations | 10 | 19 |
| 101.3.1 | Constructability Review | 10 | 19 |
| 101.3.1.1 | Purpose of the Review | 10 | 19 |
| 101.3.1.2 | Constructability Review Team | 10 | 19 |
| 101.3.1.3 | Selection of Contracting Firms Representing the Industry | 10 | 20 |
| 101.3.1.4 | Meeting Coordination and Scheduling | 10 | 20 |
| 101.3.1.5 | Constructability Review Report | 10 | 20 |
| 101.4 | Procurement and Use of SCDOT Equipment | 10 | 20 |
| 101.4.1 | Motor Vehicles | 10 | 20 |
| 101.4.1.1 | General | 10 | 20 |
| 101.4.1.2 | Care of Motor Vehicles | 10 | 20 |

| CHAPTER 10 - SCDOT CONSTRUCTION MANUAL (Continued) | | | |
|---|---|----------------|-------------|
| SUBHEADING | SECTION 101 | CHAPTER | PAGE |
| 101.4.1.3 | Use of Motor Vehicles | 10 | 21 |
| 101.4.2 | Equipment and Supplies | 10 | 21 |
| 101.4.2.1 | Acquisition of Equipment and Supplies | 10 | 21 |
| 101.4.2.2 | Expendable and Non-Expendable Equipment | 10 | 21 |
| 101.4.2.3 | Equipment Inventory | 10 | 21 |
| 101.4.2.4 | Disposal of Equipment | 10 | 22 |
| 101.5 | Documentation Considerations | 10 | 22 |
| 101.5.1 | Purpose | 10 | 22 |
| 101.5.2 | Site Manager and SCDOT Construction | 10 | 23 |
| 101.5.3 | Documentation for Payment | 10 | 23 |
| 101.6 | Site Manager Considerations | 10 | 23 |
| 101.6.1 | Daily Work Reports | 10 | 23 |
| 101.6.1.1 | General | 10 | 23 |
| 101.6.1.2 | Information Tab | 10 | 24 |
| 101.6.1.3 | Contractor Tab | 10 | 24 |
| 101.6.1.4 | Contractor Equipment Tab | 10 | 25 |
| 101.6.1.5 | Daily Staff Tab | 10 | 25 |
| 101.6.1.6 | Work Items Tab | 10 | 25 |
| 101.6.2 | Diaries | 10 | 26 |
| 101.6.2.1 | Approval of Daily Work Reports | 10 | 26 |
| 101.6.2.2 | Charging Contract Time | 10 | 26 |
| 101.6.2.3 | Changing the Status of Existing Diaries | 10 | 27 |
| 101.6.3 | Changing Orders | 10 | 27 |
| 101.6.3.1 | Explanations and Reason Codes | 10 | 27 |
| 101.6.3.2 | Item Quantity and Price | 10 | 29 |
| 101.6.3.3 | Classification and Approval | 10 | 29 |
| 101.6.3.4 | Contract Extension Approval | 10 | 30 |
| 101.6.3.5 | Contractor Concurrence | 10 | 30 |
| 101.6.4 | Estimates | 10 | 30 |
| 101.6.4.1 | Generating Estimates | 10 | 30 |
| 101.6.4.2 | Approving Estimates | 10 | 31 |
| 101.6.4.3 | Deleting Estimates | 10 | 31 |
| 101.6.4.4 | Final Estimates | 10 | 31 |
| 101.6.4.5 | Estimate Routing | 10 | 31 |
| 101.6.5 | Payrolls | 10 | 31 |
| 101.6.6 | Stockpiles | 10 | 32 |
| 101.6.6.1 | Creating Stockpiles | 10 | 32 |
| 101.6.6.2 | Installation of Items | 10 | 32 |
| 101.6.6.3 | Closing Stockpiles | 10 | 32 |
| 101.6.6.4 | Replenishing Stockpiles | 10 | 32 |
| 101.7 | Resource and Communication Considerations | 10 | 32 |
| 101.7.1 | Revisions for the Manual | 10 | 32 |
| 101.7.2 | SCDOT Intranet and Internet Web Site | 10 | 33 |
| 101.7.3 | Inquiries from the Media | 10 | 33 |
| 101.7.4 | Public Notifications | 10 | 33 |
| 101.7.4.1 | Construction Projects | 10 | 33 |
| 101.7.4.2 | Bridge Replacement Projects | 10 | 33 |
| Figure 101B | Distribution List for Press Releases | 10 | 34 |
| Figure 106B | Quality Control Sampling and Testing | 10 | 35 |

| CHAPTER 10 - SCDOT CONSTRUCTION MANUAL (Continued) | | | |
|---|--|----------------|-------------|
| SUBHEADING | Section 701: Portland Cement and Portland Cement Concrete | CHAPTER | PAGE |
| 701.1 | Description of Work | 10 | 39 |
| 701.2.1 | Concrete Quality and Temperature Control | 10 | 39 |
| 701.2 | Certification of Concrete QC/QA Personnel | 10 | 40 |
| 701.3 | Responsibilities of Concrete QC/QA Personnel | 10 | 40 |
| 701.2.4 | PCC Mix Materials | 10 | 41 |
| 701.2.4.1 | Material Source Approval | 10 | 41 |
| 701.2.4.2 | Cementitious Materials | 10 | 41 |
| 701.2.4.3 | Aggregate Materials | 10 | 43 |
| 701.2.4.4 | Water and Stabilizer Agents | 10 | 44 |
| 701.2.4.5 | Admixture Materials | 10 | 44 |
| 701.2.5 | PCC Plant and Hauling Equipment | 10 | 45 |
| 701.2.5.1 | Certification and Inspection | 10 | 45 |
| 701.2.5.2 | Scales and Metering Devices | 10 | 46 |
| 701.2.5.3 | Concrete Mixers | 10 | 47 |
| 701.2.6 | PCC Mix Design | 10 | 47 |
| 701.3 | Inspection During Construction | 10 | 48 |
| 701.3.1 | Batching and Mixing | 10 | 48 |
| 701.3.2 | Sampling and Testing | 10 | 48 |
| 701.4 | Post-construction Considerations | 10 | 49 |
| 701.5 | Documentation and Payment Considerations | 10 | 49 |
| | Section 702: Concrete Structures | | |
| 702.1 | Description of Work | 10 | 51 |
| 702.2 | Preconstruction Considerations | 10 | 51 |
| 702.2.1 | Pre-pour Conference and Checklist | 10 | 51 |
| 702.2.2 | Concrete Quality and Temperature Control | 10 | 51 |
| 702.2.3 | Mass Concrete Placement Plan | 10 | 51 |
| 702.2.4 | Crane Safety Consideration | 10 | 51 |
| 702.2.5 | Material Considerations | 10 | 52 |
| 702.2.5.1 | Material Source Approval | 10 | 52 |
| 702.2.5.2 | Portland Cement Concrete | 10 | 52 |
| 702.2.5.3 | Reinforcing Concrete | 10 | 52 |
| 702.2.5.4 | Expansion Joint Sealant Materials | 10 | 52 |
| 702.2.5.5 | Curing Materials | 10 | 53 |
| 702.2.5.6 | Surface Coatings for Concrete Finish | 10 | 54 |
| 702.2.6 | Falsework and Forms | 10 | 54 |
| 702.2.7 | Joints and Other Embedded Features | 10 | 55 |
| 702.2.8 | Dry-Run Check for Bridge Deck Pours | 10 | 55 |
| 702.2 | Inspection During Construction | 10 | 55 |
| 702.3.1 | Concrete Placement | 10 | 55 |
| 702.3.2 | Concrete Vibration | 10 | 56 |
| 702.3.3 | Wet Depth Checks | 10 | 56 |
| 702.3.4 | Removal of Falsework and Forms | 10 | 56 |
| 702.3.5 | Initial Surface Finish | 10 | 57 |
| 702.3.6 | Concrete Curing | 10 | 57 |
| 702.3.7 | Final Non-wearing Surface Finish Coat | 10 | 57 |
| 702.3.8 | Sidewalks and Curbs | 10 | 57 |
| 702.4 | Post-construction Considerations | 10 | 57 |
| 702.5 | Documentation and Payment Considerations | 10 | 58 |

CHAPTER 10 - SCDOT CONSTRUCTION MANUAL (Continued)**Section 703: Reinforcing Steel**

| SUBHEADING | SECTION TITLE | CHAPTER | PAGE |
|-------------------|--|----------------|-------------|
| 703.1 | Description of Work | 10 | 59 |
| 703.2 | Preconstruction Considerations | 10 | 59 |
| 703.3 | Inspection During Construction | 10 | 60 |
| 703.4 | Post-construction Considerations | 10 | 61 |
| 703.5 | Documentation and Payment Considerations | 10 | 61 |

CHAPTER 11 - SC-T-TEST PROCEDURES AND ADDITIONAL INSPECTOR CONCERNS

| SUBHEADING | SECTION TITLE | CHAPTER | PAGE |
|-------------------|---|----------------|-------------|
| Presentation | SC-T Procedures | 11 | 3 |
| SC-T-1 | Methods of Sampling Coarse Aggregates | 11 | 26 |
| SC-T-2 | Methods of Sampling Fine Aggregates | 11 | 31 |
| SC-T-3 | Methods of Reducing Size of Aggregate Sample | 11 | 33 |
| SC-T-40 | Procedure to Determine Aggregate Correction Factor Using the Pressure Meter | 11 | 35 |
| SC-T-45 | Slump Loss of Portland Cement Concrete | 11 | 38 |
| SC-T-46 | Making and Curing Concrete Beam Specimens | 11 | 41 |
| SC-T-47 | Method of Sampling Portland Cement, Slag, and Fly Ash | 11 | 45 |
| SC-T-49 | Determining the Rebound Number of Hardened Concrete | 11 | 46 |

CHAPTER 12 - MATH

| SUBHEADING | SECTION TITLE | CHAPTER | PAGE |
|-------------------|--|----------------|-------------|
| Q 1.1-1.4 | Squares and Rectangles | 12 | 2 |
| Q 2.1-2.5 | Circles | 12 | 3 |
| Q 3.1-3.4 | Triangles | 12 | 4 |
| Q 4.1-4.3 | Cubes | 12 | 5 |
| Q 5.1-6.4 | Geometric Shapes (Essentially Cubical) | 12 | 6 |
| Q 7.1-7.3 | Cylinders | 12 | 8 |
| Q 8.1-8.2 | Cylinders and Cubes | 12 | 9 |
| Q 9.1-9.2 | Triangular Pyramids | 12 | 10 |
| Q 10.1-10.2 | Triangular Pyramids and Cubes | 12 | 11 |
| | Solutions to Math Problems-- Q 1.1-1.2 | 12 | 12 |
| | Solutions to Math Problems-- Q 1.3-1.4 | 12 | 13 |
| | Solutions to Math Problems-- Q 2.1-2.1 | 12 | 14 |
| | Solutions to Math Problems-- Q 2.3-2.4 | 12 | 15 |
| | Solutions to Math Problems-- Q 2.5-3.1 | 12 | 16 |
| | Solutions to Math Problems-- Q 3.2 | 12 | 17 |
| | Solutions to Math Problems-- Q 3.3 | 12 | 18 |
| | Solutions to Math Problems-- Q 3.4 | 12 | 19 |
| | Solutions to Math Problems-- Q 4.1-4.2 | 12 | 20 |
| | Solutions to Math Problems-- Q 4.3 | 12 | 21 |
| | Solutions to Math Problems-- Q 5.1-5.2 | 12 | 22 |
| | Solutions to Math Problems-- Q 6.1-6.3 | 12 | 23 |
| | Solutions to Math Problems-- Q 6.4 | 12 | 24 |
| | Solutions to Math Problems-- Q 7.1-7.2 | 12 | 25 |
| | Solutions to Math Problems-- Q 7.3-8.1 | 12 | 26 |
| | Solutions to Math Problems-- Q 8.2 | 12 | 27 |
| | Solutions to Math Problems-- Q 9.1-9.2 | 12 | 28 |
| | Solutions to Math Problems-- Q 10.1-10.2 | 12 | 29 |

CHAPTER 1

General Housekeeping

In this chapter you will find:

- Course Schedule
- SCDOT Website Navigation

Have Questions? People to Contact:

Robert VanRynn – Concrete (803) 737-6689

Caleb Gunter – Structural Materials Engineer (SME)

(803) 737-6694

SCDOT Concrete Technician Certification – Level 1 and 2

Instructors:

Eddie Deaver, Holcim (US) Inc.



SCHEDULE: DAY 1

| | |
|-------------------------|---|
| 8:30 – 8:45 AM | SCDOT Website Navigation |
| 8:45 – 10 AM | Concrete 101 |
| 10AM – 10:30 AM | Qualified Product Listings |
| 10:30 – 11 AM | SCDOT Specifications: Sec. 701 / Supplemental Specifications |
| 11 – 11:30 AM | Moisture Corrections – Fine Aggregate and Mix Proportioning |
| 11:30 – 12:30 PM | Form 700.04 |
| | Break – Lunch |
| 1:30 – 2:30 PM | Aggregate Sampling / Review Questions and Answers |
| 2:30 – 3:30 PM | Construction Manual / SCDOT Specifications: Sec. 702 & Sec. 703 |
| 3:30 – 5:00 PM | Supplemental Information and Review |



SCHEDULE: DAY 2

| | |
|------------------------|---|
| 8:30 – 11:00 AM | Exam Level 1: Concrete Batching Technician |
| 11 AM – 1:00 PM | Exam Level 2: Concrete Field Inspector Technician |



INTERNET NAVIGATION: WHERE TO FIND WHAT YOU NEED

<http://www.scdot.org>



scdot.org



Construction Standards

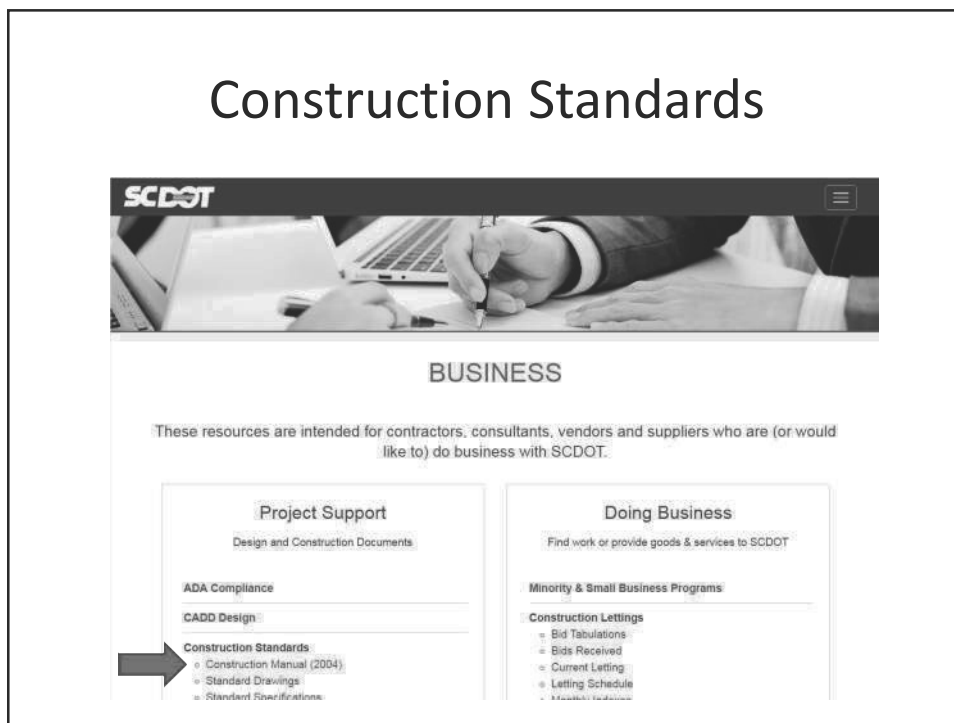

Construction Manual



SCDOT CONSTRUCTION MANUAL (2004)

- Roadway Design Home
- Construction Manual (2004)**
- Standard Drawings
- Supplemental Specifications
- Supplemental Technical Specifications
- Standard Specifications
- Preconstruction Memos

The SCDOT Construction Manual is an operational manual of the South Carolina Department of Transportation (SCDOT). It defines the criteria and procedures to be used by engineering personnel in the administration of construction contracts.

Related Documents:

- Table of Contents [↗](#) – Introduction and Table of Content
- Division 100 [↗](#) – General Provisions
- Division 200 [↗](#) – Earthwork
- Division 300 [↗](#) – Bases & Sub-bases
- Division 400 [↗](#) – Asphalt Pavements
- Division 500 [↗](#) – Concrete Pavement
- Division 600 [↗](#) – Traffic Control
- Division 700 [↗](#) – Structures
- Division 800 [↗](#) – Incidental Construction

Standard Specifications



BUSINESS

These resources are intended for contractors, consultants, vendors and suppliers who are (or would like to) do business with SCDOT.

Project Support

Design and Construction Documents

ADA Compliance

CADD Design

Construction Standards

- Construction Manual (2004)
- Standard Drawings
- Standard Specifications
- Supplemental Specifications
- Supplemental Technical Specifications
- Preconstruction Design Memorandums



Doing Business

Find work or provide goods & services to SCDOT

Minority & Small Business Programs

Construction Lettings

- Bid Tabulations
- Bids Received
- Current Letting
- Letting Schedule
- Monthly Indexes
- Tentative Letting

Design-Build

Standard Specifications

SCDOT

BUSINESS HOME

STANDARD SPECIFICATIONS FOR HIGHWAY CONSTRUCTION

Roadway Design Home

Construction Manual (2004)

Standard Drawings

Supplemental Specifications

Supplemental Technical Specifications

Standard Specifications

Preconstruction Memos

A full version of the 2007 and 2000 Standard Specifications may be viewed or downloaded below. You will need Adobe Reader to view the online version of the specifications.

2007 Standard Specifications [\[2\]](#)

2000 Standard Specifications [\[2\]](#)

Supplemental Specifications

BUSINESS

These resources are intended for contractors, consultants, vendors and suppliers who are (or would like to) do business with SCDOT.

Project Support

Design and Construction Documents

ADA Compliance

CADD Design

Construction Standards

- Construction Manual (2004)
- Standard Drawings
- Standard Specifications
- Supplemental Specifications**
- Supplemental Technical Specifications
- Preconstruction Design Memorandums
- Preconstruction Advisory Memorandums

Doing Business

Find work or provide goods & services to SCDOT

Minority & Small Business Programs

Construction Lettings

- Bid Tabulations
- Bids Received
- Current Letting
- Letting Schedule
- Monthly Indexes
- Tentative Letting

Design-Build

Supplemental Specifications

SCDOT BUSINESS HOME

SUPPLEMENTAL SPECIFICATIONS

Note: All files are presented in a PDF Format.

2007 Supplemental Specifications

| Date | Subject (PDF Format) |
|------------|---|
| 06/14/2000 | Prompt Payment Clause |
| 06/01/2001 | Bases & Subbases Quality Control/Quality Assurance |
| 11/01/2006 | Monitoring Devices - Piezometer |
| 01/11/2007 | Micro Surfacing |
| 02/01/2007 | Specifications for the Replacement or New Installation of Traffic Counting, Classification or Weigh-In-Motion Systems |
| 03/01/2007 | Critical Path Construction Schedules |
| 04/11/2007 | Exhibit C - CSXT Special Provisions |
| 01/01/2008 | Permanent Pavement Markings Fast Dry High Build Durability Waterborne Paint |
| 05/01/2008 | Gradation of Fine Aggregate FA-10M |

Supplemental Technical Specs

BUSINESS

These resources are intended for contractors, consultants, vendors and suppliers who are (or would like to) do business with SCDOT.

Project Support

Design and Construction Documents:

- ADA Compliance
- CADD Design
- Construction Standards
 - Construction Manual (2004)
 - Standard Drawings
 - Standard Specifications
 - Supplemental Specifications
 - Supplemental Technical Specifications**
 - Preconstruction Design Memorandums
 - Preconstruction Advisory Memorandums

Doing Business

Find work or provide goods & services to SCDOT

- Minority & Small Business Programs
- Construction Lettings
 - Bid Tabulations
 - Bids Received
 - Current Letting
 - Letting Schedule
 - Monthly Indexes
 - Tentative Letting
- Design-Build

Supplemental Technical Specs



SUPPLEMENTAL TECHNICAL SPECIFICATIONS

- Roadway Design Home
- Construction Manual (2004)
- Standard Drawings
- Supplemental Specifications
- Supplemental Technical Specifications**
- Standard Specifications
- Preconstruction Memos
- Preconstruction Advisory

Files are ordered by date & presented in a PDF format.

Latest Versions (to be used in all new contracts)

| Designation | Title | Letting Date |
|--------------------|---|-----------------|
| SC-M-203-1 (07/17) | Geosynthetic Materials - Separation & Stabilization | 07/17 - Present |
| SC-M-203-2 (01/18) | Geogrid Soil Reinforcement | 01/18 - Present |
| SC-M-203-3 (01/18) | Geotextile Soil Reinforcement | 01/18 - Present |
| SC-M-203-4 (07/17) | Settlement Plates | 07/17 - Present |
| SC-M-203-5 (07/18) | Lightweight Aggregates | 07/18 - Present |
| SC-M-203-6 | Vibrating-Wire Piezometer | 07/17 - |

Still under Business

- ADA Compliance
- CADD Design
- Construction Standards
 - Construction Manual (2004)
 - Standard Drawings
 - Standard Specifications
 - Supplemental Specifications
 - Supplemental Technical Specifications
 - Preconstruction Design Memorandums
 - Preconstruction Advisory Memorandums
- Engineering Directives
- Environmental Services
- Geotechnical Design
- Hydraulic Engineering
- Materials & Research**
- Plans Online
- Rights of Way
 - Property Management
- Road Design
- Seismic Design

- Minority & Small Business Programs
- Construction Lettings
 - Bid Tabulations
 - Bids Received
 - Current Letting
 - Letting Schedule
 - Monthly Indexes
 - Tentative Letting
- Design-Build
- Procurement
- Real Estate for Sale

Consultants and Contractors

Additional Resources for our partners.

- Contractor Resources
 - AGC Joint Meeting
 - As-Built Plans
 - Construction Extranet
 - Prequalification/Performance Score
 - Programmed Project Viewer
 - STIP Report

Materials and Research

SCDOT

BUSINESS HOME

MATERIALS & RESEARCH

We are dedicated to assuring that the best materials available are used in our state's roadway system. We are comprised of engineering offices and an AASHTO accredited laboratory in Columbia and three satellite laboratories in Charleston, Florence, and Greenville.

C and M Announcements

MATERIALS & RESEARCH

We are dedicated to assuring that the best materials available are used in our state's roadway system. We are comprised of engineering offices and an AASHTO accredited laboratory in Columbia and three satellite laboratories in Charleston, Florence, and Greenville.

Construction and Materials Announcements

We post updates related to construction and materials practices such as revised specifications, technician certification news, and changes to materials acceptance policies.

[Announcements >](#)

Technician Certification Program

The Technician Certification Policy provides the needed requirements for an individual to seek certification as an SCDOT certified inspector for work being performed on construction projects.

[Technician Certification >](#)

Asphalt Contractor Random Sample Tonnage

Our asphalt suppliers must sample their products on the schedule provided by this application.

[Random Sample Application >](#)

Material Acceptance

C and M Announcements

CONSTRUCTION AND MATERIALS ANNOUNCEMENTS

Here you will find updates related to construction and materials practices such as revised specifications, technician certification news, and changes to materials acceptance policies. All changes will be reflected on the home pages for each item, but here you can get a snapshot of the most recent announcements all in one place. Check back often to see what's new.

To view PDF files, you will need Adobe Acrobat Reader

UPDATED SUPPLEMENTAL SPECS EFFECTIVE JULY 2018:

4/6/2016 10:31 AM

The Supplemental Specification for Reinforcing Steel and STS for Lightweight Aggregates have been revised effective July 2018. See attached.

UPDATE YOUR LINKS!

2/7/2016 12:11 PM

New Materials and Research website [HERE](#) - update your links for QAST, OPLs, and other frequently

Technician Certification Programs

MATERIALS & RESEARCH

We are dedicated to assuring that the best materials available are used in our state's roadway system. We are comprised of engineering offices and an AASHTO accredited laboratory in Columbia and three satellite laboratories in Charleston, Florence, and Greenville.

Construction and Materials Announcements

We post updates related to construction and materials practices such as revised specifications, technician certification news, and changes to materials acceptance policies.

[Announcements >](#)

Technician Certification Program

The Technician Certification Policy provides the needed requirements for an individual to seek certification as an SCDOT certified inspector for work being performed on construction projects.

[Technician Certification >](#)

Asphalt Contractor Random Sample Tonnage

Our asphalt suppliers must sample their products on the schedule provided by this application.

[Random Sample Application >](#)

Material Acceptance

Materials and Research

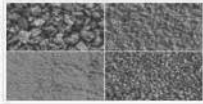

Construction and Materials Announcements

We post updates related to construction and materials practices such as revised specifications, technician certification news, and changes to materials acceptance policies.

[Announcements >](#)



Technician Certification Program

The Technician Certification Policy provides the needed requirements for an individual to seek certification as an SCDOT certified inspector for work being performed on construction projects.

[Technician Certification >](#)



Asphalt Contractor Random Sample Tonnage

Our asphalt suppliers must sample their products on the schedule provided by this application.

[Random Sample Application >](#)

Material Acceptance



The quality of materials incorporated into SCDOT construction projects is essential in the acceptance and overall quality of the final product. Materials are assessed to ensure adherence to specified requirements by varying methods including field testing, laboratory testing, and manufacturer certifications.

In addition to the SCDOT Qualified Products Lists, the information below provides guidance for ensuring that the minimum requirements for these construction materials are met.

- [Quality Acceptance Sample and Testing Guide](#)
- [Qualified Products](#)
- [Material Certifications Requirements List](#)

Qualified Products

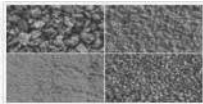

Construction and Materials Announcements

We post updates related to construction and materials practices such as revised specifications, technician certification news, and changes to materials acceptance policies.

[Announcements >](#)



Technician Certification Program

The Technician Certification Policy provides the needed requirements for an individual to seek certification as an SCDOT certified inspector for work being performed on construction projects.

[Technician Certification >](#)



Asphalt Contractor Random Sample Tonnage

Our asphalt suppliers must sample their products on the schedule provided by this application.

[Random Sample Application >](#)

Material Acceptance



The quality of materials incorporated into SCDOT construction projects is essential in the acceptance and overall quality of the final product. Materials are assessed to ensure adherence to specified requirements by varying methods including field testing, laboratory testing, and manufacturer certifications.

In addition to the SCDOT Qualified Products Lists, the information below provides guidance for ensuring that the minimum requirements for these construction materials are met.

- [Quality Acceptance Sample and Testing Guide](#)
- [Qualified Products](#)
- [Material Certifications Requirements List](#)



QPLs & QPPs

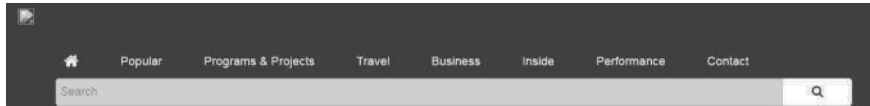

QUALIFIED PRODUCTS LISTINGS & POLICIES FOR CONSTRUCTION & MAINTENANCE MATERIALS

Qualified Products Listings (QPL) include pre-qualified materials that may be used on construction and maintenance projects as specified in the project proposal. The Qualified Products Policies (QPP) provide information to the manufacturer of the material to assist them in obtaining pre-qualified status. Each QPL and QPP indicates when the last revision occurred and a contact name in the event assistance is required.

Note: All forms are presented in a PDF Format. Items updated in the last 90 days are marked with (*).

To view PDF files, you will need Adobe Acrobat Reader

Show Only Changes in last 90 days

| Number | Description | Policy | List |
|--------|---|-----------|------------|
| 1 | Fine Aggregate Source | 8/4/2009 | 1/19/2018 |
| 2 | Coarse Aggregate Sources | 8/30/2012 | 1/17/2018 |
| 3 | Fly Ash for use in Portland Cement Concrete | 8/27/2014 | 12/20/2017 |
| 4 | Sources of Coquina Base Materials | 5/11/2007 | 1/4/2017 |
| 5 | Air Entraining and Chemical Admixtures for Concrete | 7/11/2017 | 3/21/2018* |
| 6 | Portland Cement and Non-steel Slag Manufacturers | 8/24/2017 | 11/3/2017 |

QPL 1

QUALIFIED PRODUCTS LIST 1
January 19, 2018
Page 1 of 7

SOUTH CAROLINA DEPARTMENT OF TRANSPORTATION
QUALIFIED FINE AGGREGATE SOURCES

NOTICE: THE DATA PROVIDED HEREIN IS FOR INFORMATION ONLY. MATERIALS CHARACTERISTICS WILL VARY DURING PRODUCTION. USING SOURCES LISTED ON THIS QUALIFIED PRODUCTS LIST DOES NOT RELIEVE THE CONTRACTOR OF RESPONSIBILITY FOR PROVIDING MATERIALS THAT CONFORM TO THE APPLICABLE SPECIFICATIONS FOR END USE.

| SUPPLIER | LOCATION NAME | SCDOT NO. | LOCATION | FINE MOD | ABSORP-TION, % | SPECIFIC GRAVITY, BULK SSD | SOUND, LOSS, % | NOTES |
|---------------------------|---------------------|-----------|----------------------------------|----------|----------------|----------------------------|----------------|-------------------------------|
| AMERICAN MATERIALS CO. | Pee Dee | SC506 | BRITTONS NECK, SC | 2.21 | 0.2 | 2.65 | 0.1 | 1.6 N.P.S.W |
| AMERICAN MATERIALS CO. | Plant # 240 | SC507 | JOHNSONVILLE, SC | 2.68 | 0.3 | 2.644 | 4.7 | 1.6 D.N.P.S.W |
| AMERICAN MATERIALS CO. | Richardson Mine | SC525 | BRITTONS NECK, SC | 2.14 | 0.1 | 2.641 | 0.7 | 1.N.D.P.W.S |
| AMERICAN MATERIALS CO. | I/ATHOC INC | SC562 | Wilmington, NC | 2.53 | 0.4 | 2.635 | 2.53 | 3.6 B.N.P.S |
| American Mat's/Glascock | Sumter SC | SC545 | SUMTER, SC | 2.78 | 0.6 | 2.615 | 1.2 | 1.6 N.P.S.W |
| AMERICAN MATERIALS CO. | PEE DEE | SC506 | Greshom, SC | 2.05 | 0.4 | 2.639 | 0.1 | 1.6 N.P.S.W |
| AMERICAN MATERIALS CO. | Waide Plant | SC631 | WADE, NC | 2.75 | 0.6 | 2.64 | 0.8 | 1.6 N.P.W.S |
| AMERICAN MATERIALS CO. | Black Creek Sand Ml | SC595 | MT. CROGHEN, SC | 2.28 | 0.6 | 2.62 | 3.5 | 1.6 B.N.M |
| AMERICAN SAND COMPANY | Lower Broad R. | SC547 | MOORESBORO, NC | 2.71 | 1.0 | 2.611 | 2.4 | 1.6 D.R.S.W |
| AMERICAN SAND CO. | Upper broad R. pit | SC657 | Rutherfordon, NC | 2.62 | 0.7 | 2.623 | 2.73 | 1.D.N.R.S.W |
| APAC MID-SOUTH | Warren Cty. Quarry | SC211 | CAMAK, GA. | 3.99 | 0.4 | 2.63 | 1.2 | 1.M.W.S |
| AMERICAN SAND CO. | 2" Broad R. Pit | SC658 | FOREST CITY, NC | 2.78 | 0.5 | 2.639 | 3.53 | 1.D.P.R.S.W |
| ATLANTA SAND & SUPPLY CO. | Burke Plant | SC597 | ROBERTA, GA. | 2.44 | 0.35* | 2.626* | 1.3 | 1.6 N.B.D.P.W.S, "GDOT Result |
| Aggregates Industries | Rappahannock Far | SC556 | Rappahannock Farms Sand & Gravel | 2.82 | 0.8 | 2.637 | 1.49 | 1.M.P.S.W |
| AMERICAN SAND CO. | Baly Pit | SC578 | BLACKSBURG, SC | 2.27 | 0.4 | 2.621 | 2.0 | 1.6 D.R.W.S |
| BHC TRUCKING | Boing Sand Plant | SC638 | WARE SHOALS, SC | 2.83 | 0.8 | 2.603 | 1.29 | 1.4 D.N.P.S.W |
| BLANKINSHIP SAND COMPANY | Harbersham Plant | SC842 | DEMOREST, GA. | 2.22 | 0.5 | 2.648 | 2.4 | 1.4 R.D.W.S |
| BLUEGRASS MATLS CO. LLC | Edmund | SC516 | EDMUND, SC | 2.85 | 0.4 | 2.640 | 1.5 | 1.6 B.N.S |
| BLUEGRASS MATLS CO. LLC | Callhoun Pit | SC613 | GASTON, SC | 2.87 | 0.9 | 2.611 | 1.3 | 1.6 B.N.S |
| BLUEGRASS MATLS CO. LLC | Old Charleston Hwy | SC581 | GILBERT, SC | 1.92 | 1.0 | 2.618 | 3.14 | 1.2.6 B.N.S |
| BLUE WATER INDUSTRIES | Elizabethtown, TN | SC665 | Elizabethtown Quarry | 4.05 | 1.9 | 2.555 | 5.52 | 1.2 P.M.S |
| BROAD RIVER MATERIALS | Askev Pit | SC624 | LOCKHART, SC | 2.88 | 0.7 | 2.615 | 2.1 | 1.R.D.P.W |
| BROAD RIVER MATERIALS | Cuod Pit | SC621 | LOCKHART, SC | 2.76 | 0.8 | 2.604 | 2.0 | 1.6 R.D.P.S |
| BROAD RIVER MATERIALS | Sloan Pit | SC641 | LOCKHART, SC | 2.05 | 0.7 | 2.62 | 2.5 | 1.6 D.P.R.S. |

Sampling and Testing Guide

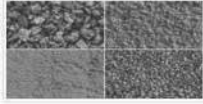

Construction and Materials Announcements

We post updates related to construction and materials practices such as revised specifications, technician certification news, and changes to materials acceptance policies.

[Announcements >](#)



Technician Certification Program

The Technician Certification Policy provides the needed requirements for an individual to seek certification as an SCDOT certified inspector for work being performed on construction projects.

[Technician Certification >](#)



Asphalt Contractor Random Sample Tonnage

Our asphalt suppliers must sample their products on the schedule provided by this application.

[Random Sample Application >](#)

Material Acceptance



The quality of materials incorporated into SCDOT construction projects is essential in the acceptance and overall quality of the final product. Materials are assessed to ensure adherence to specified requirements by varying methods including field test, laboratory testing, and manufacturer certifications.

In addition to the SCDOT Qualified Products Lists, the information below provides guidance for ensuring that the minimum requirements for these construction materials are met.

- [Quality Acceptance Sample and Testing Guide](#)
- [Qualified Products](#)
- [Material Certifications Requirements List](#)

Sampling and Testing Guide

Revised: 02/07/18



South Carolina Department of Transportation

SCDOT Quality Acceptance Sampling and Testing Guide

This guide serves as an amendment to Figure 106B & 106C of the SCDOT Construction Manual. This guide should be used in conjunction with the Materials Certification Requirement List, Qualified Products Policies & Listings, Pretested Materials Policies & Listings, and all other applicable guidance, for quality acceptance of materials to be incorporated in the work of SCDOT projects.

Sampling and Testing Guide

| Product | Material Description | Site/Manager Material Code | Minimum Sample Frequency | Sample Size | Sampling Procedure | QPL | Office to Obtain Sample | RCE to test for (Test - Minimum Frequency) | Spec. Reference | Remarks |
|-----------------------------|---|----------------------------|-------------------------------|-------------|--------------------|-------|-------------------------|--|---|--|
| Aggregate, Coarse (Non-HMA) | Aggregate, # 1 Stone | Agg1 | (1) per 500 Tons ² | (1) 40 lbs. | SC-11 | QPL 1 | RCE | - | § 501, 701, 802, Appendix A, 2, A-3, A-4, A-6, STS (2)(17) | Sample requirement waived for: (1) Temporary applications used in CMBE Curing Method 4 (2) Use in Non-structural Class 2500 concrete Small Quantity Acceptance |
| | Aggregate, # 4 Stone | Agg4 | | | | | | | | |
| | Aggregate, # 5 Stone | Agg5 | | | | | | | | |
| | Aggregate, # 5 1/2 Stone | Agg5 1/2 | | | | | | | | |
| | Aggregate, # 5 7/8 Stone | Agg5 7/8 | | | | | | | | |
| | Aggregate, # 6 7/8 Stone | Agg6 7/8 | | | | | | | | |
| | Aggregate, # 6 3/4 Stone | Agg6 3/4 | | | | | | | | |
| | Aggregate, # 7 Stone | Agg7 | | | | | | | | |
| | Aggregate, # 7 1/2 Stone | Agg7 1/2 | | | | | | | | |
| | Aggregate, # 7 3/4 Stone | Agg7 3/4 | | | | | | | | |
| | Aggregate, # 8 1/2 Stone | Agg8 1/2 | | | | | | | | |
| | Aggregate, # 8 3/4 Stone | Agg8 3/4 | | | | | | | | |
| Aggregate, Fine (Non-HMA) | Aggregate, Light Weight Stone | AggLightWeight | (1) per 500 Tons ² | (1) 30 lbs. | SC-13 | QPL 1 | RCE | - | § 501, 701, 802, Appendix A, 2, A-3, A-5, A-6, SS (3)(1)(B) | Sample requirement waived for: (1) Use in Non-structural Class 2500 concrete Small Quantity Acceptance |
| | Aggregate, FA-10 / Manufactured Sand | AggFA10M-701 | | | | | | | | |
| | Aggregate, FA-12 | AggFA12 | | | | | | | | |
| | Aggregate, FA-13 | AggFA13 | | | | | | | | |
| | Aggregate, Fine Agg. Blended | AggFA10M-701 | | | | | | | | |
| | Aggregate, Natural Sand used in Asphalt | AggNatSandND1 | | | | | | | | |
| | Aggregate, Regular Screenings | AggScr | | | | | | | | |
| | Aggregate, Washed Screenings | AggWScr | | | | | | | | |

SCT Test Procedures

• Pretested Materials Policies & Listings

Research & New Products

The SCDOT Research Program Website is hosted by the Clemson University Transportation Technology Transfer Service, T3 Service. The T3 Service has been operated by Clemson University's Civil Engineering Department and sponsored by the SCDOT and the FHWA since 1995. Information that can be found on this website includes the structure of the SCDOT Research program, all active SCDOT sponsored research studies, recently completed SCDOT sponsored research studies, current and past electronic copies of the Research Development and Technology Transfer (RD&T) Newsletter, and an electronic copy of SCDOT research problem statement form and instructions.



[Research Program Site](#) > [New Product Submission](#) >

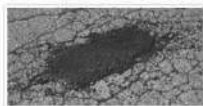

Pavement Design

SCDOT Pavement Design Guidelines provide engineering guidance on converting traffic and soil data to determine a new pavement design that will provide adequate serviceability for the design period with acceptable reliability.



Test Procedures

View our quick reference for sampling and testing procedures from the SCDOT Construction Manual and the SCDOT Laboratory Procedures Manual.

[Test Procedures](#) >

SCDOT Test Procedures

SCDOT

BUSINESS HOME

TEST PROCEDURES

We've provided a comprehensive list of sampling and testing procedures for quick reference. These procedures are from the SCDOT Construction Manual and the SCDOT Laboratory Procedures Manual.

| Videos | Concrete | Metals & Coatings |
|--|--|--|
| Methods of Sampling Course Aggregates | SCT 45 - 02/05/2010 SCT 47 - 10/06/2008 SCT 49 - 06/05/2014 SCT 50 - 05/08/2008 | SCT 134 - 01/08/2009 SCT 135 - 05/08/2008 SCT 136 - 05/08/2008 SCT 137 - 05/08/2008 SCT 139 - 03/20/2014 SCT 150 - 10/06/2008 |
| Asphalt | Soils | |
| SCT 61 - 09/01/2010 SCT 62 - 02/16/2017 | | |

SC-T-45

Standard Method of Test for

Slump Loss of Portland Cement Concrete

SCDOT Designation: SC-T-45 (09/09)

1. SCOPE

- 1.1. To determine the slump loss of freshly mixed Portland Cement Concrete over a period of time.
- 1.2. This method is typically used for drilled shaft concrete. It may also be applicable in special circumstances as deemed necessary by the RCE.
- 1.3. The purpose of this test is to ensure that drilled shaft concrete has a slump within the range specified in Subsection 701.2.12.3 of the 2007 edition of SCDOT's Standard Specifications For Highway Construction when placed and maintains a minimum slump as specified in Subsection 712.4.13.2 of the 2007 edition of SCDOT's Standard Specifications For Highway Construction.

Questions

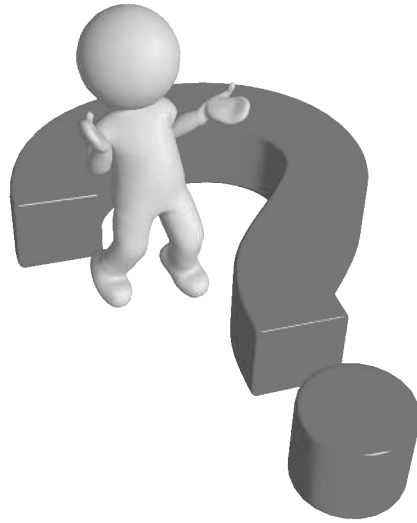

Chapter 2

SCDOT Concrete Technician Certification Course

- Concrete 101
- Concrete Materials

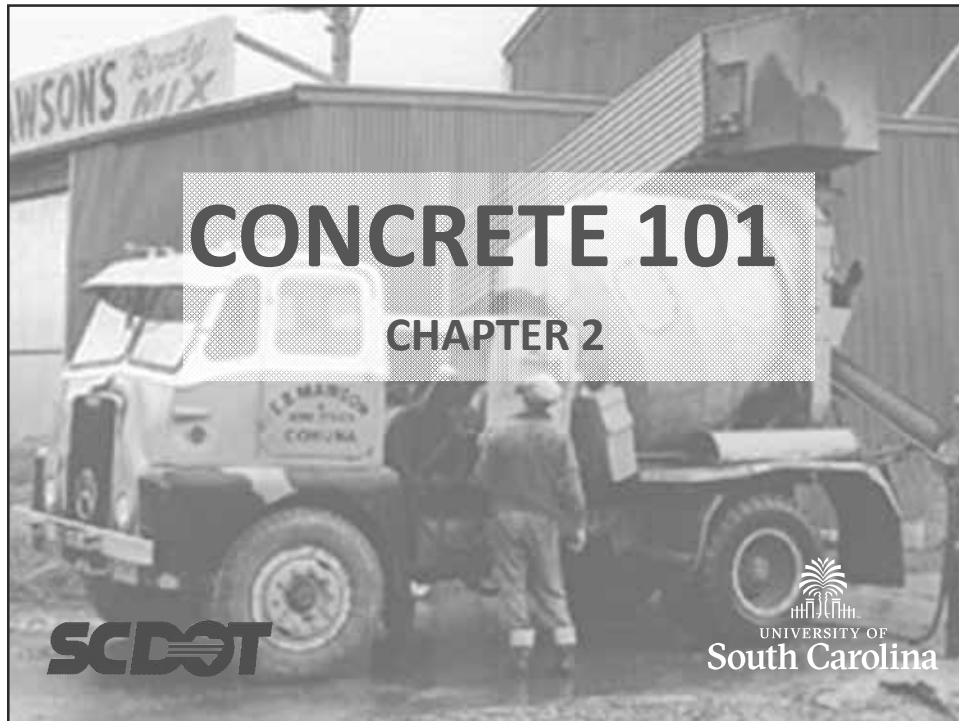

SCDOT PCC INSPECTOR: WHAT ARE WE DOING HERE?

SCDOT Portland Cement Concrete Batching and Field
Testing Technician Certification Requires:

ACI CONCRETE FIELD TESTING TECHNCIAN 1

SCDOT SUPPLEMENTAL MATERIAL



PC CONCRETE

Excellent building material used to counteract compressive stresses. It must be reinforced with steel when is subjected to tensile stresses, since concrete is weak in tension.

Concrete is a composite material:

- **Portland Cement**
- **Aggregate**
- **Water**
- **Admixtures (mineral and chemical)**



CONCRETE CONSTITUENTS

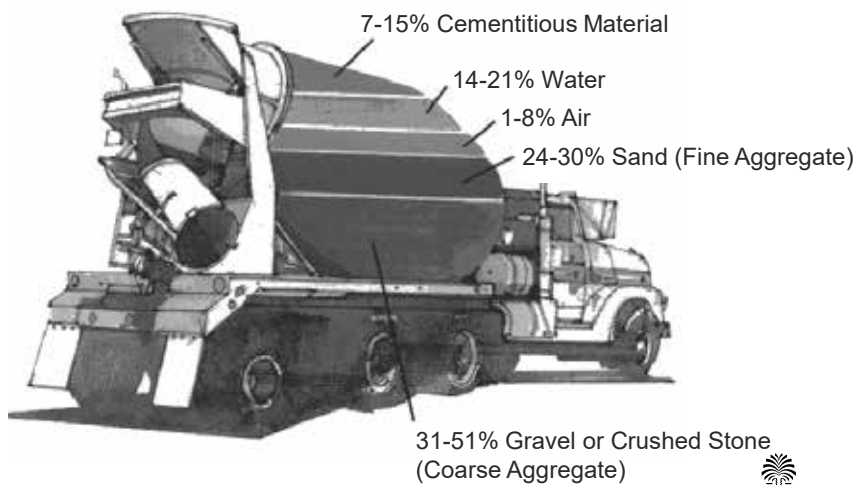

PORTLAND CEMENTS

One of the most widely used construction material and the most important hydraulic cement.

Approximate proportions for portland cements:

- **Lime (CaO) : 60-65%**
- **Silica (SiO₂) : 20-25%**
- **Iron oxide and alumina (Fe₂O₃ and Al₂O₃) : 7-12%**



PROPERTIES OF MAJOR COMPOUNDS IN PORTLAND CEMENT

- The most desirable compound is that of **tricalcium silicate (C₃S)** because it hardens rapidly and accounts for the high early strength of the cement.
- **Dicalcium silicate (C₂S)** contributes largely to strength increase at ages beyond one week.
- **Tricalcium aluminate (C₃A)** liberates a large amount of heat during the first few days of hardening. It also contributes to early-strength development.
- **Tetracalcium aluminoferrite (C₄AF)** hydrates rather rapidly but contributes very little to strength.



TYPES OF PC

There are five standard types of portland cement

- 1. ASTM Type I or Normal PC**
 - General purpose cement (not for severe climate).
- 2. ASTM Type II Moderate Sulfate or Type II(MH) Moderate Heat**
 - Moderate sulfate resistance and moderate heat of hydration
 - Used for structures of considerable mass: piers, retaining walls or concretes in moderate sulfate environments.
- 3. ASTM Type III or High-early Strength PC**
 - High strength in less than one week
 - Done with a finer grinding, better burning, such that the dicalcium silicate is less and the tricalcium silicate is greater.



TYPES OF PC (Continued)

- 4. ASTM Type IV or Low Heat of Hydration PC**
 - Develops strength at slower rate than Type I
 - Intended for mass structures, i.e. large gravity dams, where temperature on continuous pour is optimal
 - If temperature rise is not minimized, large cracks and flaws will appear
 - 5. ASTM Type V or Sulfate-resisting PC**
 - Used when concrete is to be exposed to severe sulfate action by soil or water
- The three types of Air-Entraining Cements



AASHTO M240 & ASTM C595

Blended cements allowed by SCDOT:

IS(xx): Blended GGBFS Cement

IP(xx): Blended Fly Ash Cement

IL(xx): Blend Limestone Cement



RATES OF COMPRESSIVE STRENGTH DEVELOPMENT (PCA, Design and Control of Concrete Mixtures)

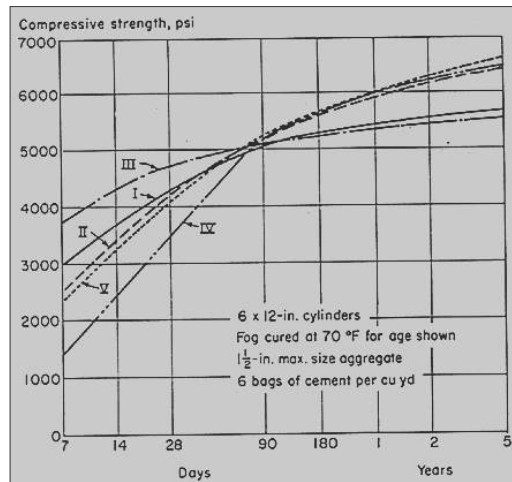

PROPERTIES OF PC

- **The Specific Gravity of Portland cement is about 3.15** and it is the used in volume calculations when determining proportions in concrete mix designs.
- **The Specific Gravity of Class F Fly Ash is assumed to be 2.25 in mix designs**, though it varies to some degree, it is used as a default when the exact number is not known. This is the specific gravity that is used by SCDOT for mix design verification.



WATER



WATER

- Any drinkable water is good for concrete. Impurities, like dissolved chemicals, seawater, sugar, and algae, may cause problems:
 1. **Abnormal setting time**
 2. **Decreased strength**
 3. **Volume changes**
 4. **Efflorescence**
- Dissolved chemicals may accelerate or retard the set and can substantially reduce the concrete strength. Can also attack the cement-sand bond, leading to early disintegration of concrete.



WATER

- Seawater containing less than 3% salt is acceptable for plain concrete but not for reinforced or prestressed concrete because of corrosion.
- Sugar, even in small amounts, can cause retarded setting.
- Algae can cause a reduction in the strength of concrete by increasing the amount of air captured in the paste and reducing the bond strength between the paste and the aggregate.



AGGREGATE

- Mineral aggregate is a mass of mineral grains or fragments used in their natural state, or prepared by crushing, screening, washing, or blending of naturally occurring rock material, usually without chemical treatment of any kind (by-product like blast-furnace slag, may be used as mineral aggregates).
- It is very important of using the right type and quality of aggregates in concrete: fine and coarse aggregates occupy 55% to 75% of the concrete volume (70% to 85% by weight).



TYPES OF MINERAL AGGREGATE

- **Natural products** (crushed stone, sand, gravel etc.) modified during their preparation only with reference to size, shape, surface texture, and the removal of foreign materials.
- **Artificial or synthetic products** (crushed furnace slag, burned clay, lightweight aggregates) prepared from natural materials whose physical properties have been changed in the course of their production.



TYPES OF MINERAL AGGREGATE

- **Fine** → passing a 3/8 in. (9.5 mm) sieve and almost entirely passing a No. 4 (4.75 mm) sieve and predominantly retained on the No. 200 (75 μ m) sieve.
- **Coarse** → predominantly retained on the No. 4 (4.75 mm) sieve.



GRADATION & AGGREGATE BLENDING

Aggregate gradation affects the workability, strength, and cost of PC Concrete mixes.

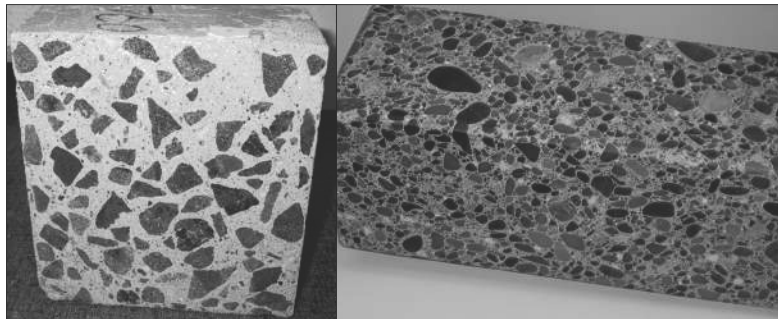

AGGREGATE BLENDING

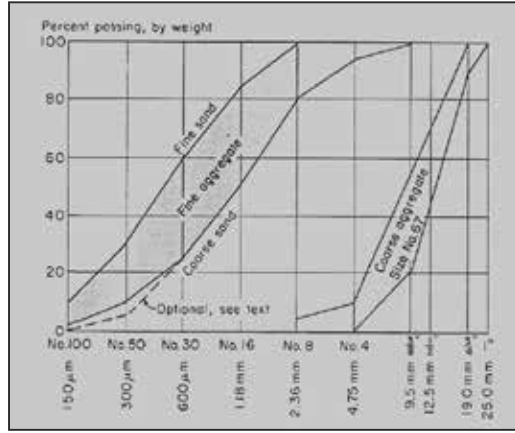
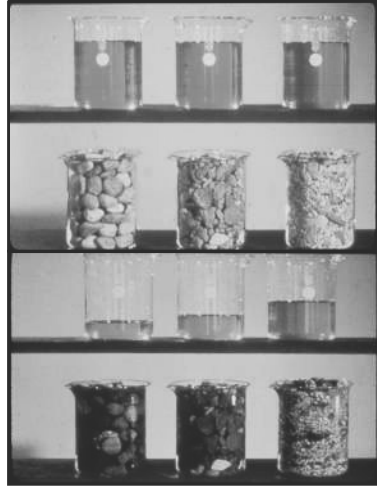

SCDOT

UNIVERSITY OF
South Carolina

EFFECT OF AGGREGATE SIZE ON WATER & CEMENT AMOUNT

PCA, Design and Control of Concrete Mixtures

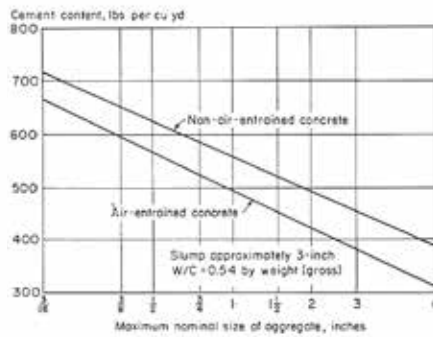
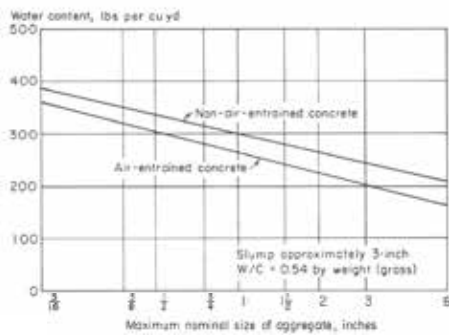

SCDOT

UNIVERSITY OF
South Carolina

CHEMICAL & MINERAL ADMIXTURES



SCDOT

UNIVERSITY OF
South Carolina

STANDARD SPECIFICATION FOR CHEMICAL ADMIXTURES FOR CONCRETE

| ASTM C 494 | |
|------------|--|
| TYPE A | Water Reducing |
| TYPE B | Retarding |
| TYPE C | Accelerating |
| TYPE D | Water Reducing and Retarding |
| TYPE E | Water Reducing and Accelerating |
| TYPE F | Water Reducing, High Range |
| TYPE G | Water Reducing, High Range & Retarding |
| TYPE S | Special Use Admixtures (SRA, VMA, HSA) |

SCDOT

UNIVERSITY OF
South Carolina

ADMIXTURES

Admixtures are those ingredients in concrete other than portland cement, water, and aggregates that are added to the mixture immediately before or during mixing.

They can be classified:

1. Air-entraining
2. Water-reducing
3. Retarding
4. Accelerating
5. Superplasticizers
6. Finely divided mineral admixtures
7. Miscellaneous workability, bonding, dampproofing, coloring, corrosion inhibiting, etc.



REASONS FOR ADMIXTURES

1. To **reduce the cost** of concrete construction.
2. To **achieve certain properties in concrete more effectively** than by other means.
3. To ensure the **quality of concrete** during the stages of mixing, transporting, placing, and curing in hostile weather conditions.
4. To **overcome certain emergencies** during concreting operations.

No admixture can be considered a substitute for good concreting practice.



1. AIR-ENTRAINING ADMIXTURES

- Air-entraining admixtures are used to entrain microscopic air bubbles in concrete. Air-entrainment will dramatically **improve the durability of concrete exposed to moisture during cycles of freezing and thawing and chemical deicers**. The workability of fresh concrete is also improved significantly. Segregation and bleeding are reduced or eliminated.
- Air-entrained concrete contains **small air-bubbles that are distributed "uniformly"** throughout the cement paste.
- Entrained air can be produced in concrete by use of air-entraining cement, admixture, or combination of both methods.



POSITIVE EFFECT OF AIR BUBBLES DURING F&T CYCLES

The pressure developed during freezing depends largely upon the distance the water must travel to the nearest air void for relief →

Air voids must be spaced close enough

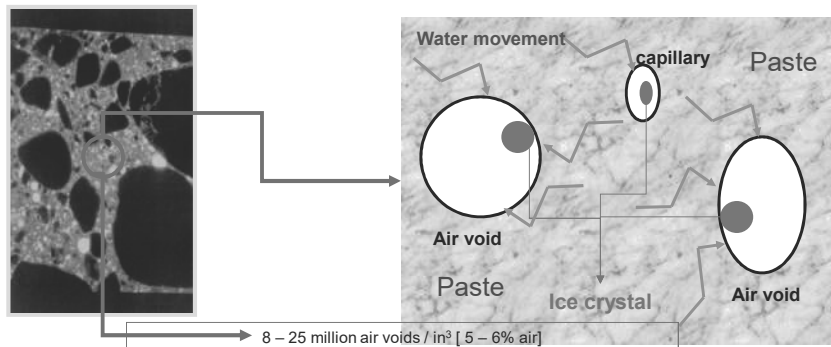

Air-entrained concrete was not introduced until 1940.



AIR-ENTRAINED CONCRETE

(PCA, Design and Control of Concrete Mixtures)

WITHOUT Entrained Air

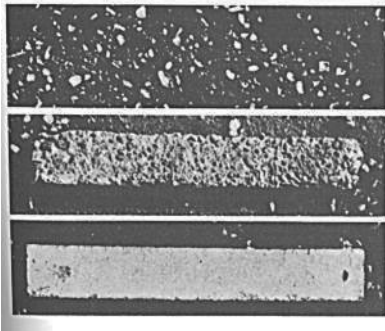

375 lb/yd³

515 lb/yd³

660 lb/yd³

WITH Entrained Air

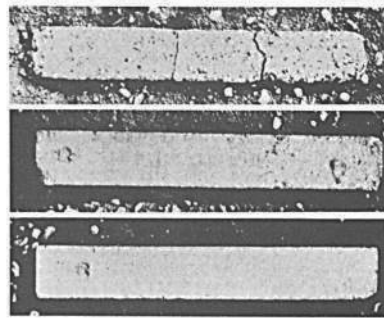

SCDOT

UNIVERSITY OF
South Carolina

2. WATER-REDUCING ADMIXTURES

- Reduce the quantity of mixing water.
- Typical water reducers → 5-10%
- High-range water reducers “superplasticizers” → 12-30%
- Increase of strength
- **PROBLEMS**
 - drying shrinkage
 - may retard the setting time

SCDOT

UNIVERSITY OF
South Carolina

3. RETARDING ADMIXTURES

- Retard the rate of setting of concrete, in cases like high temperature. A practical solution for that is to reduce the temperature of concrete by cooling the mixing water or the aggregates.
- Some reduction in strength and possible increased shrinkage at early ages can occur with the use of retarders.



4. ACCELERATING ADMIXTURES

Accelerate the strength development of concrete at an early age.

Can also be achieved by:

1. **Use Type III high-early strength PC**
2. **Lowering the w/c ratio by adding cement**
3. **Curing at higher temperature**

Calcium Chloride (CaCl_2) is the material most commonly used in accelerating admixtures. **May cause** → drying shrinkage, potential reinforcement corrosion, discoloration (darkens concrete)

It is not recommended for:

1. **Prestressed Concrete – corrosion hazard**
2. **Hot weather**
3. **Massive concrete placements**



5. SUPERPLASTICIZERS (High-range water reducers)

It is added to concrete with a low-to-normal slump and water-cement ratio to make high-slump flowing concrete.

Flowing concrete can be used in:

1. Thin section placements
2. Areas of closely spaced reinforcing steel
3. Underwater placements
4. Pumped concrete to reduce pump pressure

Reduce also the w/c ratio (12-30%) that can produce concretes with:

1. Ultimate Strength Compressive Strength in excess of 10,000 psi
2. Increase early strength, etc.

The effect of superplasticizers in increasing workability is short-lived, 30 to 60 minutes; it is added at the jobsite.



6. FINELY DIVIDED MINERAL ADMIXTURES

Improve or change some of the plastic or hardened properties of portland cement concrete.

Based on their chemical or physical properties they are classified as:

- Cementitious materials (ground granulated blast-furnace slag, natural cement etc.)
- Pozzolans (fly ash and silica fume)
- Pozzolanic and Cementitious materials.



FLY ASH

- **Fly ash is a pozzolan** - a siliceous or aluminosiliceous material that in itself possesses limited or no cementitious value but will react with the calcium hydroxide released by the hydration of pc to form a compound possessing cementitious properties.
- It is a **byproduct of coal-fired electric** generating plants.
- Fly ash particles are generally spherical and similar in size to pc: typical particle size under 20 μm .
- W/C: water/cementitious materials ratio



EFFECTS OF FLY ASH

| PROS | CONS |
|--|----------------------------------|
| Strength Gain | Decreases Air Entraining Ability |
| Improves Workability | Decreases Early Strength |
| Reduces Bleeding | Seasonal Limitations |
| Reduces Heat of Hydration | |
| Reduces Permeability | |
| Increases Resistance to Sulfate Attack | |
| Lowers Costs | |



SILICA FUME

- It is a result of the manufacture of silicon or ferrosilicon alloy in an electric arc furnace.
- It has spherical shape extremely fine particles with less than $1\mu\text{m}$ in diameter. They are about 100 times smaller than average portland cement particles.



EFFECTS OF FRESHLY MIXED CONCRETE

1. Requires more water
2. Decreases air content
3. Reduces workability
4. Decreases segregation and bleeding
5. Retards setting time of concrete
6. Requires longer period of curing



EFFECTS ON HARDENED CONCRETE

1. Increases strength
2. Increases early strength
3. Reduces permeability
4. Improves the resistance to sulfate or seawater attack
5. Reduces corrosion by reducing permeability
6. Slightly increases carbonation
7. Improves freeze-thaw resistance



CORROSION INHIBITORS

- Concrete protects embedded steel from corrosion through its highly alkaline nature. The high pH causes a passive and noncorroding protective oxide film to form on steel. Carbonation or the presence of chloride ions from deicers or seawater can destroy or penetrate the film → **CORROSION**.
- Calcium nitrite, the most commonly used liquid corrosion inhibitor, blocks the corrosion reaction of the chloride ions by chemically reinforcing and stabilizing the passive film. A certain amount of calcium nitrite can stop corrosion up to a certain threshold of chloride ions.
- Calcium nitrite is an accelerator and affects other properties of concrete (air entraining).



CONCRETE MIXING

Concrete should be mixed thoroughly until it is uniform in appearance with all ingredients evenly distributed.

Ready Mixed
Concrete Methods:

- Central Mixed
- Shrink Mixed
- Truck Mixed



IT'S NOT CONCRETE, IF IT'S NOT MIXED

The concrete was batched out of a dry-batch plant, then taken to the jobsite with the mixer in agitate speed (4 rpm). The concrete was mixed at the jobsite 20, 40, 50, and 70 total revolutions at mixing speed (12 rpm). Tests were taken at various stages of the mixing.

| Test No. | Number @ 4 RPM (Agitate) | of @ 12 RPM (Mix) | Revs. Total Revs. | 7 Day PSI | 28 Day PSI | WT. Cu. ft. | Total Air % | Slump INCH. | Yield Cu. Ft. / Yard |
|----------|--------------------------|-------------------|-------------------|-----------|------------|-------------|-------------|-------------|----------------------|
| 1 | 84 | 0 | 84 | 1920 | 2400 | 146.5 | 2.9 | 1.00 | 26.08 |
| 2 | 84 | 20 | 104 | 2080 | 2800 | 145.7 | 3.2 | 1.25 | 26.22 |
| 3 | 84 | 40 | 124 | 2270 | 3000 | 145.0 | 3.5 | 1.75 | 26.34 |
| 4 | 84 | 50 | 134 | 2420 | 3210 | 143.8 | 4.4 | 2.50 | 26.56 |
| 5 | 84 | 70 | 154 | 3200 | 4010 | 141.0 | 6.0 | 4.00 | 27.09 |



CURING

(PCA, Design and Control of Concrete Mixtures)

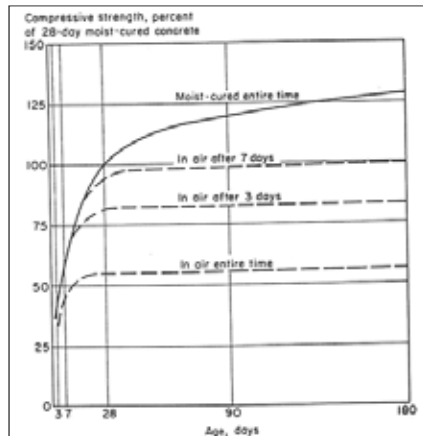

SCDOT

UNIVERSITY OF
South Carolina

PRINCIPAL REQUIREMENTS

Three Principal Requirements:

1. QUALITY
2. WORKABILITY
2. ECONOMY

SCDOT

UNIVERSITY OF
South Carolina

2. CONCRETE MATERIALS 101

Material presented in boxes is more technical in nature and corresponds to the initial portion of the review course presentation. **These materials are not components of the SCDOT specifications, they represent general guidelines only!** SCDOT policies, procedures, and reference values will be located in subsequent sections.

2.1 What is Concrete?

In its simplest form, concrete is a mixture of paste and aggregate (sand & rock). The paste, composed of cement and water, coats the surface of the fine (sand) and coarse aggregate (rocks) and binds them together into a rock-like mass known as concrete.

Within this process lies the key to a remarkable trait of concrete: it's plastic and can be molded or formed into any shape when newly mixed, strong and durable when hardened. These qualities explain why one material, concrete, can build skyscrapers, bridges, sidewalks, and superhighways, houses and dams.

The key to achieving a strong, durable concrete rests on the careful proportioning and mixing of the ingredients. A concrete mixture that does not have enough paste to fill all the voids between the aggregate will be difficult to place and will produce rough, honeycombed surfaces and porous concrete. A mixture with an excess of cement paste will be easy to place and will produce a smooth surface; however, the resulting concrete will be more likely to crack and be uneconomical.

A properly designed concrete mixture will possess the desired workability for the fresh concrete and the required durability and strength for the hardened concrete. Typically, a mix is by volume about 10 to 15 percent cement, 60 to 75 percent aggregate and 15 to 20 percent water. Entrained air bubbles in many concrete mixtures may also take up another 5 to 8 percent.

History of Portland Cement Concrete There are several milestones in the development of PC concrete including:

- 1 Portland cement was patented by J. Aspdin in 1824. Aspdin selected this name for his powdery material because it resembled a natural limestone quarried on the Isle of Portland in England.
- 2 J. Monier, a Parisian gardener, is considered as the inventor of reinforced concrete due to a patent he received in 1865 for making flower tubs.
- 3 T.P. Hyatt tested and published a series of tests on reinforced concrete conducted in London between 1870 and 1875.
- 4 The first Portland cement in the U.S. was produced by D. Saylor at Coplay, Pennsylvania in 1875.
- 5 The first U.S. reinforced concrete home was built by W. Ward at Port Chester, New York in 1875. Several newspaper reporters were close by to report the collapse, as they expected, of the new structure made out of a "strange" material called reinforced concrete. The structure is still standing, safe and strong.
- 6 D. Abrams established a rational basis for proportioning concrete mixes in 1910. The effect of the water/cement ratio (0.3-0.6) was, for the first time, quantified.
- 7 Prestressed concrete was introduced by E. Freyssinet in 1928. This was possible due to the development of high strength steel wire for prestressing.
- 8 Air-entrained concrete was introduced in 1940 and from 1960 we have an explosive growth of admixtures.

2.1.1 Portland Cement and other Cementitious Materials

There is a common misunderstanding that cement and concrete are one and the same. Portland cement is the active ingredient in concrete and usually makes up 10 to 20 percent of the weight of a concrete mix. Cement is manufactured by fusing several minerals together in a large kiln and grinding the resultant cement clinker into a fine powder. When Portland cement contacts water, a chemical reaction, called hydration, takes place, leading to the formation of a new, hard compound. In the production of concrete, Portland cement is frequently blended with fly ash, slag cement or other cementitious materials.

Cements

Cements are materials that exhibit characteristic properties of setting and hardening when mixed with water. They can be classified:

1. Hydraulic: they set and harden under water i.e. hydraulic limes, natural cements, Portland cement etc.
2. Non-hydraulic: they require air to harden, i.e. lime.

Portland Cement (PC)

It is one of the most widely used materials in construction and the most important hydraulic cement. The essential constituents of pc are lime, silica, alumina, and iron oxide. Lime does not occur in nature but is found in materials like limestone, chalk or oyster shells. Silica and alumina are found free in nature in the form of shale, clay, and blast furnace slag. A small amount of gypsum is added during the production of pc to retard its setting. Four major compounds are found in pc:

1. Tricalcium silicate 3CaO SiO_2 (C3S) 45-60%: The most desirable compound because it hardens rapidly and accounts for the high early strength of pc concrete.
2. Dicalcium silicate 2CaO SiO_2 (C2S) 15-30%: It contributes largely to strength increase at ages beyond one week.
3. Tricalcium aluminate $3\text{CaO Al}_2\text{O}_3$ (C3A) 6-12%: It is responsible for the large amount of heat liberated during the first few days of hardening. It also contributes to the early-strength development.
4. Tetracalcium aluminoferrite $4\text{CaO Al}_2\text{O}_3 \text{Fe}_2\text{O}_3$ (C4AF) 6-8%: It hydrates rather rapidly but contributes very little to strength.

There are five standard types of pc (excluding the 3 air-entrained) as follows:

- ASTM Type I or normal pc: It is the general-purpose cement.
- ASTM Type II or moderate pc: It is recommended for moderate sulfate resistance and moderate heat of hydration. It is used for structures of considerable mass such as piers and retaining walls.
- ASTM Type III or high early strength pc: It is used when a high early strength pc concrete is required. This is done with a finer grinding, better burning, such that the dicalcium silicate is less and the tricalcium silicate is greater.
- ASTM Type IV or low heat of hydration pc: It develops strength at slower rate than does Type I. It is intended for mass structures such as large gravity dams where the temperature rise on the continuous pour is great. If the temperature rise is not minimized large cracks and flaws would appear.
- ASTM Type V or sulfate-resisting pc: It is used when concrete is to be exposed to severe sulfate action by soil or water.

The character of concrete is determined by the quality of the paste. The strength of the paste, in turn, depends on the ratio of water to cement. The water-cement ratio is the weight of the mixing water divided by the weight of all cementitious material (including cement, fly ash and silica fume). High-quality concrete is produced by lowering the water-cement ratio as much as possible without sacrificing the workability of fresh concrete. Generally, using less water produces a higher quality concrete provided the concrete is properly placed, consolidated and cured.

Properties of PC

There are several specifications regarding the chemical composition and physical properties of pc. Such physical properties include:

- 1 Fineness (90% of pc particles are less than 45 μm): It affects the rate of hydration. The greater the fineness the greater the rate of hydration and hence the greater the strength development during the first seven days.
- 2 Soundness of hardened cement paste: It is a measure of the ability to retain its volume after setting. Lack of soundness leads to expansive forces.
- 3 Time of setting: The length of time that concrete remains plastic is dependent upon the chemical composition, fineness, water content, and temperature.
- 4 Compressive strength: It is determined by mixing the cement specimen with uniform silica sand and water in prescribed proportions and molding the mixture into 2in. x 2in. x 2in cubes.
- 5 Heat of hydration: Heat generated when water and cement react. It depends on the chemical composition, fineness of the cement, and the temperature during curing.
- 6 Loss of ignition: It is determined by heating a cement sample of known weight to a full red heat of 1,652 °F until a constant weight is obtained. The loss of weight is determined. This is an indication of pre-hydration and carbonation, which may be caused by improper or prolonged storage.
- 7 Specific gravity: It is about 3.15 and is not an indication of cement's quality.

Besides Portland Cement, concrete may contain other cementitious materials including fly ash, a waste product from coal burning electric power plants; ground slag, a byproduct of iron and steel manufacturing; and silica fume, a waste product from the manufacture of silicon or ferro-silicon metal. Some of these cementitious materials are similar to the volcanic ashes the Romans mixed with lime to obtain their cement binder. Some of these Roman structures still exist today! The concrete industry uses these materials, which would normally have to be disposed in land-fill sites, to the advantage of concrete. The materials participate in the hydration reaction and significantly improve the strength, permeability and durability of concrete.

Admixtures for PC Concrete

Admixtures are those ingredients in concrete other than Portland cement, water, and aggregates that are added to the mixture immediately before or during mixing. They can be classified:

- 1 Air-entraining
- 2 Water-reducing
- 3 Retarding
- 4 Accelerating
- 5 Superplasticizers
- 6 Finely divided mineral admixtures
- 7 Miscellaneous: workability, bonding, damp-proofing, coloring, corrosion inhibiting etc.

Concrete should be workable, finishable, strong, durable, watertight, and wear resistant. These qualities can often be obtained easily and economically by the selection of suitable materials (except air-entraining admixtures when needed). The major reasons of using admixtures are:

1. To reduce the cost of concrete construction.
2. To achieve certain properties in concrete more effectively than by other means.
3. To ensure the quality of concrete during the stages of mixing, transporting, placing, and curing in hostile weather conditions.
4. To overcome certain emergencies during concreting operations.

No admixture can be considered a substitute for good concreting practice.

1. Air-Entraining Admixtures (mid-1930's)

Air-entraining admixtures are used to entrain microscopic air bubbles in concrete. Air-entrainment will dramatically improve the durability of concrete exposed to moisture during cycles of freezing and thawing and chemical deicers. The workability of fresh concrete is also improved significantly. Segregation and bleeding are reduced or eliminated. Air-entrained concrete contains small air-bubbles that are distributed "uniformly" throughout the cement paste. Entrained air can be produced in concrete by use of air-entraining cement, admixture, or combination of both methods.

2. Water-Reducing Admixtures

They are used to reduce the quantity of mixing water by 5 to 10%. High-range water reducers ("superplasticizers") can be used to reduce the amount of water by 12 to 30%. The major benefit of reducing the mixing water is the increase of the strength of pc concrete. A retard of the setting time and an increase of drying shrinkage may be caused by these kind of admixtures.

3. Retarding Admixtures

They retard the rate of setting of concrete in cases like concrete exposed to high temperature during placement. A practical solution for that is to reduce the temperature of concrete by cooling the mixing water or the aggregates. Some reduction in strength at early ages accompanies the use of retarders.

4. Accelerating Admixtures

They can be used to accelerate the strength development of concrete at an early age. This, however, can be also achieved by: (a) use Type III high-early strength Portland cement, (b) lowering the w/c ratio by adding cement, and (c) curing at higher temperature. Calcium chloride (CaCl) is the material most commonly used in accelerating admixtures. It may cause some problems such as drying shrinkage, corrosion, and discoloration (darkens concrete). It is not recommended for prestressed concrete, hot weather, and massive concrete placements.

5. Superplasticizers (High-range water reducers)

It is added to concrete with a low-to-normal slump and water-cement ratio to make high-slump flowing concrete. Flowing concrete can be used in thin section placements, in areas of closely spaced reinforcing steel, underwater placements, and in pumped concrete to reduce pump pressure. Reduction of w/c ratio (12-30%) can produce concretes with ultimate compressive strength in excess of 10,000 psi and higher early strength etc. The effect of superplasticizers in increasing workability is short-lived, 30 to 60 minutes, and so it should be added at the jobsite.

6. Finely Divided Mineral Admixtures

They improve or change some of the plastic or hardened properties of Portland cement concrete. Based on their chemical or physical properties they are classified as: (a) cementitious materials (ground granulated blast-furnace slag, natural cement etc.), (b) pozzolans (fly ash and silica fume), and (c) pozzolanic and cementitious materials.

Fly Ash is a pozzolan, meaning is a siliceous or aluminosiliceous material that possesses limited or no cementitious values but will react with the calcium hydroxide released by the hydration of pc to form a compound possessing cementitious properties. It is a byproduct of coal-fired electric generating plants. Fly ash particles are generally spherical and similar in size to pc. Typical particle size is less than 20 μm . Fly ash may affect positively the produced concrete by increasing the strength, improving workability, reducing bleeding, reducing heat of hydration, reducing permeability, increasing resistance to sulfate attack, increasing resistance to alkali-silica reactivity, and reducing the cost. It may affect, however, negatively the produced concrete by decreasing air entraining ability and decreasing early strength.

Silica Fume is a result of the manufacture of silicon or ferrosilicon alloy in an electric arc furnace. It has spherical shape extremely fine particles with less than 1 μm in diameter. The particles are about 100 times smaller than the average pc particles. It has some significant effects on freshly mixed concrete including: a) requires more water, b) decreases air content, c) reduces workability, d) decreases segregation and bleeding, e) retards setting time of concrete, and f) requires longer period curing. It affects also the hardened concrete including: a) increases the strength, b) increases early strength, c) reduces permeability, d) improves the resistance to sulfate or seawater attack, e) reduces corrosion by reducing permeability, f) increases slightly carbonation, and g) improves freeze-thaw resistance.

7. Corrosion Inhibitors Concrete protects embedded steel from corrosion through its highly alkaline nature. The high pH causes a passive and non-corroding protective oxide film to form on steel. Carbonation or the presence of chloride ions from deicers or seawater can destroy or penetrate the film and initiate corrosion.

Calcium nitrite, the most commonly used liquid corrosion inhibitor, blocks the corrosion reaction of the chloride ions by chemically reinforcing and stabilizing the passive film. A certain amount of calcium nitrite can stop corrosion up to a certain threshold of chloride ions. Calcium nitrite, however, is also an accelerator and affects other properties of concrete.

2.1.2 Aggregate

Aggregate for concrete is chosen carefully. Aggregate comprises 60 to 75 percent of the total volume of concrete. The type and size of the aggregate mixture depends on the thickness and purpose of the final concrete product. Relatively thin building sections can require small coarse aggregates, though aggregate up to six inches (150 mm) in diameter have been used in large dams. A continuous gradation of particle sizes is desirable for efficient use of the paste. In addition, aggregate should be clean and free from any matter that might affect the quality of the concrete.

Aggregate

Mineral aggregate is a mass of mineral grains or fragments used in their natural state, or prepared by crushing, screening, washing, or bleaching of natural occurring rock material, usually without chemical treatment of any kind (by-product like blast-furnace slag, may be used as mineral aggregates).

It is very important to use the right type and quantity of aggregates in concrete since fine and coarse aggregates occupy 55% to 75% of the pc concrete volume (70% to 85% by weight). Aggregates may be classified as natural or artificial products. Natural aggregates (crushed stone, sand, gravel etc.) are modified during their preparation only with reference to size, shape, surface, texture, and removal of foreign materials. Artificial aggregates (crushed furnace slag, burned clay, lightweight aggregates etc.) are prepared from natural materials whose physical properties have been changed in the course of their production. Aggregates may further be classified as fine and coarse. Fine aggregates pass a 3/8 in. (9.5 mm) sieve and almost entirely pass a No.4 (4.75 mm) sieve and are predominantly retained on a No.200 (75 µm) sieve. Coarse aggregates are predominantly retained on a No. 4 (4.75 mm) sieve.

2.1.3 Water

Almost any natural water that is drinkable (potable) and has no pronounced taste or odor may be used as mixing water for concrete. Occasionally, some waters that are not fit for drinking may be suitable for concrete.

Excessive impurities in mixing water may not only affect curing time and concrete strength, but also may cause efflorescence, staining, corrosion of reinforcement, volume instability and reduced durability.

Specifications usually set limits on chlorides, sulfates, alkalis, and solids in mixing water unless tests indicate that the water will not negatively impact concrete properties.

All water to be used for concrete must be tested except that supplied by a public water system.

2.1.4 Hydration

After the aggregate, water, and the cement are combined, the mixture remains in a plastic condition for about four to six hours which permits transporting, placing and finishing in its final location, then the mixture starts to harden. All Portland cements set and harden through a chemical reaction with water. During this reaction, called hydration, a node forms on the surface of each cement particle. The node grows and expands until it links up with nodes from other cement particles or adheres to adjacent aggregates. The building up process results in progressive stiffening, hardening, and strength development.

Once the concrete is thoroughly mixed and workable it should be placed in forms before the mixture becomes too stiff. During placement, the concrete is consolidated to compact it within the forms and to eliminate potential flaws, such as honeycombing and air voids.

2.2 What Is Ready Mixed Concrete?

Ready mixed concrete refers to concrete that is delivered to the customer in a freshly mixed and unhardened state. Due to its durability, low cost and its ability to be customized for different applications, ready-mixed concrete is one of the world's most versatile and popular building materials.

Principal Requirements for PC Concrete

There are three principal requirements that should be considered for designing pc concrete mixtures:

1. Quality
2. Workability
3. Economy

Quality

It is measured by pc concrete's strength and durability. The strength (compressive, flexural etc.) should provide the ability to a structure to carry safely the applied loads. It depends (assuming sound aggregate) on water/cement ratio and the extent to which hydration has progressed. Hydration is a chemical reaction between water and cement while concrete is hardening and responsible for the unique properties of concrete. Durability of concrete is the ability to resist the forces of disintegration due to freezing and thawing and chemical attack.

Workability

It is the characteristic indicating the ease with which the mass of the plastic material may be deposited in its final place. It depends on the size and gradation of the aggregate, the amount of mixing water, the time of mixing, etc. It is difficult to be measured. Slump tests (measure of consistency) are used to assess workability. It is usually between 2-4 in. with min 1 in., and it increases by 1 in. by adding 10 lb of water per cubic yard of concrete.

Economy

Effective use of materials, effective operation, and ease of handling gives good quality and economical pc concrete mixtures.

2.2.1 Ordering Information

The purchaser determines the concrete quality (in terms of its properties or composition) and quantity or volume required for the particular application.

2.2.1.1 Quality

Three model formats for ordering ready mixed concrete are suggested by the ASTM C 94, *Standard Specification for Ready Mixed Concrete*. These formats are:

Performance format: Purchaser specifies aggregate size, slump, air content, and strength. Sometimes, the purchaser can specify the strength level and intended use of concrete such as driveway or basement walls. This is the best way to order ready mixed concrete because the ready mixed concrete (RMC) producer, who is an expert in this field, would design an economical mix with the desired properties. The RMC producer accepts responsibility for the design of the mixture.

Prescription format: Purchaser specifies aggregate size, slump, air content, cement content or weight of cement per cubic yard of concrete, maximum water content and admixtures required. In this case, the purchaser accepts responsibility for concrete strength and performance.

Mixed format: Purchaser specifies aggregate size, slump, and air content, required strength, minimum cement content, and admixtures. This format is generally discouraged as the performance requirements may conflict with the prescriptive parameters.

Where the purchaser's specifications differ from these three model formats, the purchaser's specifications govern.

2.2.1.2 Quantity

Concrete is bought and sold by volume in a freshly mixed and unhardened state. The most frequently used unit measure is the cubic yard or cubic meter. A cubic yard is 27 cubic feet of volume, that is 3 feet in length, width, and height. One cubic yard of concrete weighs about 4000 lb. (2 short tons). One cubic meter is approximately 1.3 cubic yards and weighs about 2400 kg (2.4 metric tons).

When ordering concrete, make sure that you order 4% to 10% more concrete than is estimated from a volumetric calculation of the plan dimensions. This will account for the following:

- Waste or spillage
- Over-excavation
- Spreading of forms
- Some loss of entrained air
- Settlement of wet mixture
- Change in volume – dry concrete volume is 1% to 2% less than fresh concrete volume

It is important that you do not order too much concrete. The processing and disposal of returned concrete is an expensive proposition for the ready mixed concrete producer, who has to comply with various environmental regulations. Be environmentally friendly! Towards the end of a large job, reevaluate the additional volume of concrete you need and communicate this to your concrete supplier.

2.3 Production of Ready Mixed Concrete

2.3.1 Proportioning

The proportioning of a concrete mix design should result in an economical and practical combination of materials to produce concrete with the properties desired for its intended use, such as workability, strength, durability and appearance.

The ready mixed concrete producer may independently select the material proportions to provide the performance you need or may receive instructions through the job specifications, such as minimum cement content, air content, slump, maximum size of aggregate, strength, and others. The RMC producer is the expert in selecting the proportions based on previously developed guidelines and experience.

Regardless of the source of instructions, there are established methods for selecting the proportions for concrete for each batch. The *Standard Practice for Selecting Proportions for Normal, Heavyweight, and Mass Concrete* (ACI 211.1-91) published by the American Concrete Institute Committee 211 is often referenced for selecting concrete proportions.

Here are the basics of a good concrete mix:

Portland cement and water combine chemically to bind the sand and aggregate together. Fly ash or other cementitious materials, which enhance concrete properties, may supplement some of the cement. The key to quality concrete is to use the least amount of water that can result in a mixture that can be easily placed, consolidated and finished.

Fine and coarse aggregate make up about 70% of the concrete volume and impart volume stability to the concrete. Concrete aggregates are required to meet appropriate specifications and in general should be clean, strong and durable.

Admixtures are generally products used in relatively small quantities to improve the properties of fresh and hardened concrete. They are used to modify the rate of setting and strength development of concrete, especially during hot and cold weather. The most common is an air-entraining agent that develops millions of tiny air bubbles in concrete, which imparts durability to concrete in freezing and thawing exposure. Water reducing admixtures enable concrete to be placed at the required consistency while minimizing the water used in the mixture, thereby increasing strength and improving durability. A variety of fibers are incorporated in concrete to control cracking or improve abrasion and impact resistance.

2.3.2 Production

2.3.2.1 Transit Mixed (or "truck-mixed") Concrete

In transit-mixed concrete, also called truck mixed or dry-batched, all of the raw ingredients are charged directly in the truck mixer. Most or all water is usually batched at the plant. The mixer drum is turned at charging (fast) speed during the loading of the materials. There are three options for truck mixed concrete:

Concrete mixed at the job site. While traveling to the job site the drum is turned at agitating speed (slow speed). After arriving at the job site, the concrete is completely mixed. The drum is then turned for 70 to 100 revolutions, or about five minutes, at mixing speed.

Concrete mixed in the yard. The drum is turned at high speed or 12-15 rpm for 50 revolutions. This allows a quick check of the batch. The concrete is then agitated slowly while driving to the job site.

Concrete mixed in transit. The drum is turned at medium speed or about 8 rpm for 70 revolutions while driving to the job site. The drum is then slowed to agitating speed.

2.3.2.2 Shrink Mixed Concrete

Concrete that is partially mixed in a plant mixer and then discharged into the drum of the truck mixer for completion of the mixing is called shrink mixed concrete.

Central mixing plants that include a stationary, plant-mounted mixer are often actually used to shrink mix, or partially mix the concrete. The amount of mixing that is needed in the truck mixer varies in these applications and should be determined via mixer uniformity tests. Generally, about thirty turns in the truck drum, or about two minutes at mixing speed, is sufficient to completely mix shrink-mixed concrete.

2.3.2.3 Central Mixed Concrete

Central-mixing concrete batch plants include a stationary, plant-mounted mixer that mixes the concrete before it is discharged into a truck mixer. Central-mix plants are sometimes referred to as wet batch or pre-mix plants. The truck mixer is used primarily as an agitating haul unit at a central mix operation. Dump trucks or other non-agitating units are sometimes be used for low slump and mass concrete pours supplied by central mix plants. About 20% of the concrete plants in the US use a central mixer. Principal advantages include:

- Faster production capability than a transit-mix plant,
- Improved concrete quality control and consistency, and
- Reduced wear on the truck mixer drums.

There are several types of plant mixers, including:

- Tilt drum mixer
- Horizontal shaft paddle mixer
- Dual shaft paddle mixer
- Pan mixer
- Slurry mixer

The tilting drum mixer is the most common American central mixing unit. Many central-mix drums can accommodate up to 12 yd³ and can mix in excess of 200 yd³ per hour. They are fast and efficient, but can be maintenance-intensive since they include several moving parts that are subjected to a heavy load.

Horizontal shaft mixers have a stationary shell and rotating central shaft with blades or paddles. They have either one or two mixing shafts that impart significantly higher horsepower in mixing than the typical drum mixer. The intensity of the mixing action is somewhat greater than that of the tilt drum mixer. This high energy is reported to produce higher strength concrete via to thoroughly blending the ingredients and more uniformly coating the aggregate particles with cement paste. Because of the horsepower required to mix and the short mixing cycle required to complete mixing, many of these mixers are 4 or 5 yd³ units and two batches may be needed to load a standard truck or agitator.

Pan mixers are generally lower capacity mixers at about 4 to 5 yd³ and are used at precast concrete plants.

The slurry mixer is a relative newcomer to concrete mixing technology. It can be added onto a dry-batch plant and works by mixing cement and water that is then loaded as slurry into a truck mixer along with the aggregates. It is reported to benefit from high-energy mixing. Another advantage is that the slurry mixer reduces the amount of cement dust that escapes into the air.

2.3.2.4 "Mix Mobiles" - Mobile Volumetric Proportioning Plants

"Mix Mobile" are truck-mounted, volumetric batching and continuous mixing units. These "plants-on-wheels" often supply small-volume or specialty pours and offer the convenience of freshly mixed concrete in fairly precise quantities. The unit consists of a truck with bins of sand, coarse aggregate, cement, water, and admixtures. The aggregate bins have longitudinal belts at the bottom of the sand, and as well as coarse aggregate bins that drag the aggregate to separate adjustable gates at the rear of the bin. The speed of the belts is connected to a feeder in a cement bin, and all three materials drop down into a mixer. Flow meters control the introduction of water and admixtures.

2.3.2.5 Batch Plants Styles

Concrete batch plants come in a variety of styles and configurations designed to accommodate a variety of markets, technical and environmental considerations.

Portable Plants have a cement silo and an overhead bin for sand or one or two coarse aggregate types.

Permanent Plants operate from same location for a relatively long period of time. Large quantities of materials of greater variety are stored at the plant. The plant will tend to have larger overhead storage and may have two lanes to permit batching two trucks at the same time. Plants may be also classified as:

High profile – the traditional stack up plant is a tall plant that has aggregate and cement storage bins that feed into batchers or weigh hoppers by gravity.

Low profile – the aggregate weigh hoppers are near the ground with belts to elevate the aggregate to load the mixer.

2.3.3 Delivery

2.3.3.1 The Truck Mixer

While ready mixed concrete can be delivered to the point of placement in a variety of ways, the overwhelming majority of it is brought to the construction site in truck-mounted, rotating drum mixers. Truck mixers have a revolving drum with the axis inclined to the horizontal. Inside the shell of the mixer drum are a pair of blades or fins that wrap in a helical (spiral) configuration from the head to the opening of the drum. This configuration enables the concrete to mix when the drum spins in one direction and causes it to discharge when the direction is reversed.

To load, or charge, raw materials from a transit mix plant or centrally mixed concrete into the truck, the drum must be turned very fast in the charging direction. After the concrete is loaded and mixed, it is normally hauled to the job site with the drum turning at a speed of less than 2 rpm.

Since its inception in the mid-1920's, the traditional truck-mixer has discharged concrete at the rear of the truck. Front discharge units, however, are rapidly becoming more popular with contractors. The driver of the front discharge truck can drive directly onto the site and can mechanically control the positioning of the discharge chute without the help of contractor personnel.

Currently, because of weight laws, the typical truck mixer is a 9 to 11 yd³ unit. The drums are designed with a rated maximum capacity of 63% of the gross drum volume as a mixer and 80% of the drum volume as an agitator. Generally, ready mixed concrete producers load their trucks with a quantity at or near the rated mixer capacity.

Fresh concrete is a perishable product that may undergo slump loss depending on temperature, time to the delivery point on the job site, and other factors. Water should not be added to the mix unless the slump is less than that which is specified. If water is added, it should be added all at once and the drum of the truck mixer should be turned a minimum of 25 revolutions, or about two minutes, at mixing speed.

In certain situations, air-entraining, water reducing, set-retarding or high-range water reducing admixtures may need to be added to concrete prior to discharge to compensate for loss of air, high temperatures or long delivery times. The ready mixed concrete producer will assist the purchaser in such circumstances.

2.3.4 Inspection and Testing

Concrete is a manufactured product. Specific control tests and evaluations are required during the manufacturing process to produce predictable high-quality concrete. The customer may want to verify that concrete meets specifications. Some of the important properties of concrete that are measured by basic quality control tests are strength, temperature, slump, air content, and unit weight. In general concrete is tested at a frequency of 1 in 150 cubic yards. Concrete should also be tested for each structural element placed, such as footings, columns and caps.

Each test helps to determine the quality of concrete and it should be performed in accordance with American Society for Testing and Materials (ASTM) standards. A SCDOT certified Portland Cement Technician must make the tests.

When there are no formal job specifications, such as with a homeowner or small contractor, it is important for the concrete producer to agree to furnish concrete in accordance with ASTM C 94 or at least certain critical sections of ASTM C 94. This reference should also be included on the delivery ticket.

ASTM C 94 includes a number of things that should be a part of any agreement between the producer and a purchaser. Some of them are:

- Define the basis of purchase, cubic yards, and how it is measured.
- Define acceptable material specifications and acceptable industry practice and tolerances.
- Define strength testing procedures and acceptance criteria.
- Set laboratory personnel qualifications. The testing laboratory must comply with ASTM C 1077, which is required in ASTM C 94.

Strength of PC Concrete

Strength of concrete, in compression, tension, shear, or combination of these, is, in most cases, directly related to load-carrying capacity of plain and reinforced concrete. Strength properties can usually be determined more easily than all the other properties of hardened concrete. Strength tests can be also used as a qualitative indication of other important properties of hardened concrete. It is important for the safety of the structure to check the strength of concrete. Adjustments can be made in case of low strength.

Compressive Strength

Concrete exhibits its best strength characteristics when subjected to compressive loading. Compressive strength is the most important property of concrete. Other strength properties can be estimated based on the compressive strength. Tensile strength, for example, can be taken as 10-12% of the compressive strength. Flexural strength, as measured by modulus of rupture, is about 15 to 20% of the compressive strength. The compressive strength of concrete depends primarily on the w/c ratio but also on the character of the cement, conditions of mixing, character and grading of aggregates, size of aggregates, curing and aging, temperature, and moisture content. The principal effect of changing the aggregate grading is to change the amount of cement and water needed to make the mixture workable. The surface roughness and texture of aggregates have greater effect on the flexural strength than on the compressive strength of concrete.

2.4 Inspecting a Ready Mix Plant

What do you look for when inspecting a ready mix plant for SCDOT?

Ensure that the plant is listed on the QPL28.

Plants are certified through a third-party (NRMCA & CRMCA) per QPP28.

Chapter 3

Select SCDOT Qualified Product Policies

The most current versions of the SCDOT Qualified Product Policies are available online:
http://info.scdot.org/Construction_D/SitePages/QualifiedProducts3.aspx

| Policy Number | Topic | Page Number |
|----------------------|---|--------------------|
| 1 | Fine Aggregate | 9 |
| 2 | Coarse Aggregate | 13 |
| 3 | Fly Ash | 16 |
| 5 | Air Entraining Agents and Chemical Admixtures | 18 |
| 6 | Portland Cement and Slag | 20 |
| 7 | Surface Coatings | 22 |
| 10 | Bridge Deck Waterproofing Membrane Type 1 | 24 |
| 11 | Cold Applied Sealants for Bridge Joints | 25 |
| 18 | Type IS Portland Blast-furnace Slag Cement | 27 |
| 22 | Rapid Patch Material for Concrete Pavement | 28 |
| 28 | Ready Mix Concrete Plants | 30 |
| 32 | Stabilizer Agents for Mixer Drum Wash Water | 32 |
| 33 | Curing Compounds for Concrete Structures | 33 |
| 53 | Corrosion Inhibitors for Concrete | 37 |
| 54 | Temporary Concrete Barrier Producers | 39 |
| 60 | Reinforcing Steel | 40 |
| 69 | Reinforced Concrete Pipe | 44 |
| 73 | Mechanical Couplers for Reinforcing Steel | 46 |
| 81 | Preformed Rubber Joint Filler | 48 |
| 86 | Type IL Portland-Limestone Cement | 49 |

QPL & QPP

(Chapter 3)



MATERIAL SPECIFICATIONS

The vendors who provide materials:

Qualified Materials List



QUALIFIED PRODUCTS LISTINGS

- **The QP Policies and Listings are numbered concurrently**
 - EX. Policy 1 explains how to become a vendor of fine aggregate and Listing 1 provides a register of who is currently eligible to sell fine aggregate for SCDOT work.
- **The QP Listings are updated Frequently on the SCDOT Website.**



RELEVANT POLICIES & LISTINGS

1. Fine Aggregate
2. Course Aggregate
3. Fly Ash
5. Air Entraining Agents & Chemical Admixtures
6. Portland Cement & Slag
7. Surface Coatings
10. Bridge Deck Waterproofing Membrane I
11. Cold Applied Sealants for Bridge Joints
18. Type I Slag Modified Portland Cement
22. Rapid Patch Materials for Concrete Pavement



RELEVANT POLICIES & LISTINGS

- 28. Ready-mix Concrete Plants
- 32. Stabilizing Agents & Mixer Drum Wash Water
- 33. Curing Compounds
- 53. Corrosion Inhibitors for Concrete
- 54. Temporary Concrete Barrier Products
- 60. Reinforcing Steel
- 69. Reinforced Concrete Pipe
- 73. Mechanical Couplers for Reinforcing Steel
- 81. Preformed Rubber Joint Filler
- 86. Type IL Portland Limestone Cement



QUALIFIED PRODUCTS LISTINGS

Find QP Listing 1 for Fine Aggregate (Ch.3 Page 2)

Look at the top row of the table

- The Supplier, Location Name and Location are all given

Physical data is given for each product

**** Always pay special attention to the NOTES –
In the right-most column**



QP LISTING NOTES

There will be a notes key and/or a legend along with an explanation for any relevant notes located at the end of each QP Listing.

The Notes Key → qualifiers on the use of a product.

The Legend Key → material source and preparation.



EXAMPLE

Does the fine aggregate produced by Vulcan at its North Quarry located in Winston Salem, NC meet the FA-10 Gradation?

ANSWER:

According to Note 2 and QPL Page Header it does NOT.

However this product can be used for FA-10M (M=Manufactured) purposes.

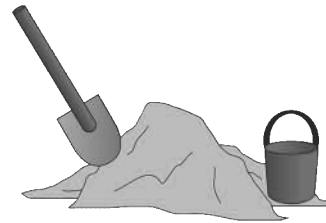

QUALIFIED PRODUCTS LISTINGS

You will know to use the QP Listings in Ch. 3 to answer **ANY** question that relates to a **SPECIFIC PRODUCT**.

1. What is the minimum cure time for the spray on surface coating Triko-Plex sold by Proko Industries?

ANSWER:

2. What is the application rate for sprayed final finish coatings applied to the underside of bridges?

ANSWER:

Do you see the difference in the question type?



QUALIFIED PRODUCTS LISTINGS

(Formerly Approval Policies)

- Outline the criteria governing material and vendor suitability for any/all materials used in SCDOT work.
- Verified compliance with any approval policy is required to become a SCDOT vendor.
- Upon verification, the vendor will be listed on the appropriate Qualified Products Listing.



SOUTH CAROLINA DEPARTMENT OF TRANSPORTATION
QUALIFIED FINE AGGREGATE SOURCES

NOTICE: THE DATA PROVIDED HEREIN IS FOR INFORMATION ONLY. MATERIALS CHARACTERISTICS WILL VARY DURING PRODUCTION. USING SOURCES LISTED ON THIS QUALIFIED PRODUCTS LIST DOES NOT RELIEVE THE CONTRACTOR OF RESPONSIBILITY FOR PROVIDING MATERIALS THAT CONFORM TO THE APPLICABLE SPECIFICATIONS FOR END USE.

| SUPPLIER | LOCATION NAME | SCDOT NO. | LOCATION | FINE-NESS MODULUS | ABSORPTION, % | SPECIFIC GRAVITY, BULK SSD | SOUNDNESS LOSS, % | NOTES |
|-----------------------------|----------------------|-----------|---------------------|-------------------|---------------|----------------------------|-------------------|-----------------|
| AGGREGTES USA | Dogwood Q. | SC146 | GROVETOWN, GA. | 3.23 | 0.2 | 2.66 | 0.1 | 1,6,M,W,S |
| ALABAMA SAND & GRAVEL | | SC612 | BILLINGSLEY, AL | 2.62 | 0.2 | 2.65 | 1.4 | 1,N,B,P,W,S |
| AMERICAN MATERIALS COM. | Clark Pit | SC575 | WADE, NC | 2.34 | 0.4 | 2.64 | 5.8 | 1,6,N,P,W,S |
| AMERICAN MATERIALS COM. | Richardson Mine | SC625 | BRITTONS NECK, SC | 2.56 | 0.2 | 2.64 | 1.7 | 1,6,N,D,P,W,S |
| AMERICAN MATERIALS COM. | Wade Plant | SC631 | WADE, NC | 2.41 | 0.2 | 2.65 | 0.8 | 1,6,N,P,W,S |
| ATLANITA SAND & SUPPLY CO. | Burke Plant | SC597 | ROBERTA, GA | 2.34 | 0.4 | 2.65 | 1.3 | 1,6,N,B,D,P,W,S |
| AZALEA UTILITIES, INC | Shoo Fly Mine | SC598 | SUMMERVILLE, SC | 2.57 | 0.4 | 2.57 | 1.9 | 1,6,N,B,P,W,S |
| BAILEY SAND COMPANY | Baily Pit | SC578 | BLACKSBURG, SC | 2.89 | 0.3 | 2.63 | 3.3 | 1,6,D,R,W,S |
| B & B SAND COMPANY | Saluda River | SC563 | MARIETTA, SC | 2.74 | 1.5 | 2.56 | 3.0 | 1,6,R,D,W,S |
| BHC TRUCKING | Boling Sand Plant | SC638 | WARE SHOALS, SC | 2.74 | 0.3 | 2.62 | 1.2 | 1,D,R,S,W |
| B & T SAND COM. | Edmund | SC516 | EDMUND, SC | 2.91 | 0.1 | 2.65 | 1.5 | 1,6,B,N,S |
| B & T SAND COM. | Old Charleston Hwy | SC581 | GILBERT, SC | 2.10 | 0.9 | 2.60 | 0.5 | 1,6,B,N,S |
| BROWN SAND | Tyger River Pit | SC585 | UNION, SC | 3.03 | 0.8 | 2.60 | 0.2 | 1,6,D,R,S,W |
| BROWN BROTHERS SAND | | SC555 | JUNCTION CITY, GA | 2.62 | 0.1 | 2.65 | 6.8 | 1,N,P,W |
| BROWN & WATSON | Butler Sand | SC566 | BUTLER, GA. | 2.30 | 0.3 | 2.63 | 1.2 | 1,6,N,B,W |
| B. V. HEDRICK GRAVEL & SAND | Lilesville | SC505 | LILESVILLE, NC | 2.78 | 0.8 | 2.63 | 0.8 | 1,6,N,P,S,W |
| CAROLINA SAND, INC. | Pee Dee | SC506 | BRITTONS NECK, SC | 2.94 | 0.1 | 2.65 | 0.1 | 1,N,P,S,W |
| CAROLINA SAND, INC. | Plant # 240 | SC507 | JOHNSONVILLE, SC | 2.54 | 0.1 | 2.65 | 4.7 | 1,6,D,N,P,S,W |
| C B SAND COMPANY | Plant # 2 | SC576 | GUYTON, GA | 2.42 | 0.1 | 2.65 | 0.0 | 1,6,N,D,P,S,W |
| C B SAND COMPANY | Plant # 3 | SC618 | GUYTON, GA | 2.62 | 0.1 | 2.65 | 2.8 | 1,6,N,D,P,S,W |
| CEMEX | Deerfield | SC544 | RIDGELAND, SC | 2.47 | 0.1 | 2.65 | 2.0 | 1,6,N,P,S |
| CEMEX | Union Sand Mine | SC594 | LUDOWICI, GA | 2.67 | 0.2 | 2.64 | 2.4 | 1,6,N,P,W |
| CLARK ENOREE SAND | | SC600 | WHITMIRE, SC | 2.84 | 0.6 | 2.63 | 2.1 | 1,R,D,S |
| COLLETON SAND | | SC603 | WALTERBORO, SC | 2.33 | 0.1 | 2.66 | 2.0 | 1,6,B,P,W,S |
| COLUMBIA SILICA | Dixiana (unwashed) | SC520 | PINERIDGE, SC | 2.33 | 0.6 | 2.61 | 1.0 | 1,6,N,B,S,P |
| COLUMBIA SILICA | Dixiana (washed) | SC520 | PINERIDGE, SC | 2.20 | 0.2 | 2.62 | 0.6 | 1,6,N,B,W,S,P |
| CONSTRUCTION MATERIALS G. | Black Creek Sand | SC595 | MT. CROGHEN, SC | 2.53 | 0.3 | 2.64 | 0.4 | 1,6,N & M |
| COOPER SAND | Saluda River | SC583 | EASLEY, SC | 2.45 | 0.4 | 2.62 | 1.7 | 1,4,6,R |
| COOPER SAND | Holiday Circle | SC521 | EASLEY, SC | 2.91 | 1.2 | 2.59 | 3.2 | 1,6,D,R |
| COASTAL SAND, INC. | | SC629 | GUYTON, GA. | 2.30 | 0.2 | 2.64 | 4.6 | 1,6,N,D,P,W,S |
| DECK SAND COM. INC | B. R. Harris Pit | SC523 | RUTHERFORDTON, NC | 2.54 | 0.7 | 2.62 | 2.3 | 1,D,W,R,S |
| FLORIDA ROCK INDUSTRIES | | SC553 | GRANDIN, FLA. | 2.40 | 0.2 | 2.64 | 0.6 | 1,6,N,W,S |
| FLORIDA ROCK INDUSTRIES | | SC572 | WEIRDALE, FLA. | 2.18 | 0.4 | 2.64 | 0.3 | 1,6,N,B,W,S |
| GLENN SAND COMPANY | Ellis Ferry Road Pit | SC528 | SHELBY, NC | 2.19 | 0.3 | 2.64 | 1.7 | 1,6,D,R,W,S |
| GRAND STRAND AGG. | Goretown Mine | SC101 | LORIS, SC | 2.97 | 1.8 | 2.59 | 1.8 | 1,6,M,P,S,W |
| G S MATERIALS | Emery Pit | SC580 | JACKSON SPRINGS, NC | 2.63 | 0.2 | 2.65 | 0.7 | 1,6,N,W,S |

QUALIFIED PRODUCTS LIST 1

* For Class Purposes Only*
Page 2 OF 4

The following sources did not meet gradation requirements for FA-10 and are qualified only for blending with other sands to achieve a composite blend that meets gradation requirements.

| SUPPLIER | LOCATION NAME | SCDOT NO. | LOCATION | FINE-NESS MODULUS | ABSORPTION, % | SPECIFIC GRAVITY, BULK SSD | SOUND-NESS LOSS, % | NOTES |
|--------------------------|--------------------|-----------|-------------------------|-------------------|---------------|----------------------------|--------------------|-------------|
| AGGREGATES USA | Hitchcock Q. | SC171 | MACON, GA. | 3.46 | 0.3 | 2.71 | 0.7 | 2.6,M,W |
| B & T SAND | Calhoun Pit | SC613 | GASTON, SC | 1.47 | 0.1 | 2.66 | 1.3 | 2.6,B,N,S |
| BUCKHORN MATERIALS | Lynches River | SC191 | JEFFERSON, SC | 3.40 | 0.5 | 2.65 | 0.6 | 2.6,M,W,N&M |
| CAROLINA STALITE COMPANY | Gold Hill | SC103 | SALISBURY, NC | 3.06 | 1.2 | 1.89 | 0.3 | 2.6,L,M |
| CAROLINA STALITE COMPANY | Aquadale | SC102 | ALBEMARLE, NC | 3.28 | 0.8 | 2.01 | 1.4 | 2.6,L,M |
| CHARLESTON MILL SERVICE | Nucor, Huger Plant | SC178 | HUGER, SC | 3.94 | 0.4 | 2.80 | 2.1 | 2,M,S,P |
| COLUMBIA SILICA | Tindal Mine | SC519 | EDMUND, SC | 1.84 | 0.6 | 2.62 | 2.5 | 2.6,B,N |
| COLUMBIA SILICA | Princeton Mine | SC518 | S. CONGAREE, SC | 1.89 | 0.8 | 2.62 | 1.1 | 2.6,N,B |
| DECK SAND | Broad River Pit | SC522 | CLIFFSIDE, SC | 3.34 | 0.2 | 2.63 | 2.8 | 2,D,R,S,W |
| HANSON AGG. | | SC173 | ATHENS, GA | 3.36 | 0.2 | 2.69 | 3.6 | 2.6,M,W |
| HANSON AGG. | Monroe Q. | SC197 | BOLINGBROKE, GA. | 2.74 | 0.1 | 2.81 | 4.2 | 2.6,M,W |
| HANSON AGGR. | Lowrys Q. | SC112 | McCONNELLS, SC | 3.21 | 0.4 | 2.64 | 1.1 | 2.6,M,P,W |
| MARTIN MARIETTA AGG | Appling | SC120 | APPLING, GA. | 3.52 | 0.2 | 2.65 | 0.7 | 2.6,M,W |
| MARTIN MARIETTA AGG | Augusta | SC134 | AUGUSTA, GA. | 3.60 | 0.7 | 2.65 | 1.1 | 2,M,W |
| MARTIN MARIETTA AGG | Bakers | SC136 | MONROE, NC | 3.33 | 0.7 | 2.74 | 1.1 | 2.6,M,W |
| MARTIN MARIETTA AGG. | Berkeley | SC125 | EUTAWVILLE, SC | 3.33 | 4.8 | 2.44 | 15.7 | 2,M,S,W |
| MARTIN MARIETTA AGG. | | SC128 | HICKORY, NC | 2.21 | 0.3 | 2.74 | 3.1 | 2.6,M,P,W |
| MARTIN MARIETTA AGG. | Georgetown II Q. | SC129 | JAMESTOWN, SC | 3.61 | 2.3 | 2.61 | 5.8 | 2.6,M,W |
| MARTIN MARIETTA AGG. | Chesterfield Q. | SC130 | JEFFERSON, SC | 3.42 | 0.5 | 2.62 | 0.9 | 2.6,M,S,P,W |
| MARTIN MARIETTA AGG. | Jefferson Quarry | SC586 | JEFFERSON, GA. | 2.83 | 0.1 | 2.70 | 0.2 | 2.6,M,W |
| MARTIN MARIETTA AGG. | | SC144 | STATESVILLE, NC | 2.42 | 0.1 | 2.88 | 0.3 | 2.6,M,W,S |
| VULCAN MATERIALS CO. | | SC149 | BLAIR, SC | 2.25 | 0.3 | 2.68 | 1.2 | 2.6,M,W |
| VULCAN MATERIALS CO. | Cabarrus | SC152 | CONORD, NC | 3.27 | 0.5 | 2.78 | 1.0 | 2.6,M,P,S,W |
| VULCAN MATERIALS CO. | | SC157 | HENDERSONVILLE, NC | 2.97 | 0.1 | 2.68 | 0.5 | 2,M,P,W |
| VULCAN MATERIALS CO. | | SC160 | LYMAN, SC | 2.25 | 0.5 | 2.77 | 0.5 | 2.6,M,W |
| VULCAN MATERIALS CO. | Jack Q. | SC202 | PETERSBURG, VA. | 3.61 | 0.5 | 2.65 | 1.0 | 2,M,W |
| VULCAN MATERIALS CO. | | SC185 | PISGAH FOREST, NC | 3.46 | 0.4 | 2.65 | 2.3 | 2.6,M,P,W |
| VULCAN MATERIALS CO. | North Quarry | SC187 | WINSTON-SALEM, NC | 3.13 | 0.4 | 2.85 | 0.9 | 2.6,M,P,W |
| WILSON SAND CO. | Frick (unwashed) | SC636 | Batesburg-Leesville, SC | 1.96 | 0.1 | 2.65 | 1.1 | 2.6,B,N,S |

QUALIFIED PRODUCTS LIST 1

For Class Purposes Only
Page 3 of 4

The following NATURAL SAND sources are qualified for use in asphalt mixes.

| SUPPLIER | LOCATION NAME | SCDOT NO. | LOCATION | % Silt | % Clay | % Total Sand |
|------------------------------|-----------------------|-----------|-------------------|--------|--------|--------------|
| AMERICAN MATERIALS | Richardson Mine | SC625 | BRITTONS NECK, SC | 0.1 | 0.3 | 100 |
| ANDREWS SAND | | SC607 | ANDREWS, SC | 1.1 | 1.4 | 98 |
| AZALEA UTILITIES | Shoo Fly Mine | SC598 | GIVHANS, SC | 0.6 | 1.3 | 98 |
| B & B SAND CO. | Saluda River Pit | SC563 | MARIETTA, SC | 0.4 | 0.2 | 99 |
| B & T SAND | Calhoun Pit | SC613 | GASTON, SC | 0.9 | 1.7 | 97 |
| B & T SAND | Old Charleston Rd. | SC581 | GILBERT, SC | 2.4 | 5.1 | 93 |
| BAILEY SAND | Bailey Pit | SC578 | BLACKSBURG, SC | 0.3 | 0.4 | 99 |
| BHC TRUCKING | Boling Pit | SC638 | WARE SHOALS, SC | 0.9 | 1.1 | 98 |
| BROWN SAND CO. | Tyger River Pit | SC585 | UNION, SC | 0.3 | 0.3 | 99 |
| CAROLINA SAND | Pee Dee | SC506 | BRITTONS NECK, SC | 0.1 | 0.3 | 100 |
| CEMEX | Deerfield | SC544 | TILLMAN, SC | 0.9 | 0.5 | 99 |
| CLARK ENOREE SAND | | SC600 | WHITMIRE, SC | 0.3 | 0.1 | 100 |
| Construction Materials Group | Black Creek Sand Mine | SC595 | MT. CROGHEN, SC | 1.6 | 4.9 | 94 |
| COOPER SAND Co. | Saluda Lake Pit | SC583 | EASLEY, SC | 0.1 | 0.3 | 100 |
| COOPER SAND Co. | HW Place Pit | SC521 | WARE PLACE, SC | 0.5 | 0.4 | 99 |
| DECK SAND CO. | Harris Pit | SC523 | RUTHERFORDTON, SC | 0.3 | 0.1 | 100 |
| DECK SAND CO. | Broad River Pit | SC522 | CLIFFSIDE, NC | 0.5 | 0.3 | 99 |
| GLOVER SAND | | SC577 | RIDGELAND, SC | 0.9 | 3.1 | 96 |
| COLUMBIA SILICA | Dixiana Mine | SC520 | PINERIDGE, SC | 1.0 | 2.3 | 97 |
| GLENN SAND | Ellis Ferry Rd. Pit | SC528 | SHELBY, NC | 0.3 | 0.3 | 99 |
| HANSON AGGREGATES | Brewer | SC529 | PAGELAND, SC | 1.3 | 4.4 | 94 |
| HANSON AGGREGATES | Marlboro | SC106 | BENNETTSVILLE, SC | 0.3 | 5.1 | 95 |
| HEDRICK INDUSTRIES | Piedmont Sand | SC541 | PAGELAND, SC | 1.4 | 2.9 | 96 |
| H. R. COFFIN & SONS | HR Coffin Mine | SC617 | CONWAY, SC | 0.0 | 0.4 | 100 |
| INMAN STONE | Pacolet River | SC513 | CONVERSE, SC | 0.3 | 0.5 | 99 |
| INMAN STONE | Slater Pit | SC509 | LANDRUM, SC | 0.3 | 0.3 | 99 |
| INMAN STONE | Deaton Pit | SC561 | SPARTANBURG, SC | 0.4 | 0.3 | 99 |
| INMAN STONE | Theo Pit | SC571 | ENOREE, SC | 0.4 | 0.3 | 99 |
| LANIER SAND | | SC589 | COLUMBIA, SC | 0.3 | 2.0 | 98 |
| LOVELESS & LOVELESS | | SC537 | PONTIAC, SC | 0.5 | 1.0 | 99 |
| MARTIN MARIETTA AGG. | Kershaw Sand | SC626 | BETHUNE, SC | 1.7 | 3.4 | 95 |
| McINTYRE SAND CO. | Askew Site | SC624 | LOCKHART, SC | 0.7 | 0.4 | 99 |
| McINTYRE SAND CO. | Cudd Pit | SC621 | LOCKHART, SC | 0.4 | 0.0 | 100 |
| MURRY MINES | Principal Mine | SC593 | RIDGEVILLE, SC | 0.0 | 0.1 | 100 |
| NEWBERRY SAND | | SC627 | NEWBERRY, SC | 0.5 | 0.3 | 99 |
| PAGELAND SAND | | SC640 | MT. CROGHAN, SC | 1.3 | 4.7 | 94 |

QUALIFIED PRODUCTS LIST 1

For Class Purposes Only
Page 4 of 4

The following NATURAL SAND sources are qualified for use in asphalt mixes.

| SUPPLIER | LOCATION NAME | SCDOT NO. | LOCATION | % Silt | % Clay | % Total Sand |
|-----------------------|-----------------------|-----------|------------------|--------|--------|--------------|
| PALMETTO SAND | Pine Bluff Mine | SC601 | RIDGEVILLE, SC | 0.6 | 2.1 | 97 |
| PALMETTO AGGREGATES | Saluda River Pit # 1 | SC559 | PIEDMONT, SC | 0.4 | 0.1 | 100 |
| PALMETTO AGGREGATES | Saluda River Pit # 2 | SC620 | PIEDMONT, SC | 0.4 | 0.5 | 99 |
| PALMETTO AGGREGATES | Saluda River Pit # 3 | SC637 | PIEDMONT, SC | 0.1 | 0.3 | 100 |
| REA CONTRACTING | First Broad River Pit | SC615 | SHELBY, NC | 1.3 | 1.2 | 98 |
| REA CONTRACTING | Buffalo Creek Pit | SC622 | GROVER, NC | 0.4 | 0.2 | 99 |
| REA CONTRACTING | Ocain Sand | SC604 | ORANGEBURG, SC | 3.2 | 4.4 | 92 |
| REA CONTRACTING | Ulmer Pit | SC605 | ULMER, SC | 0.9 | 4.0 | 95 |
| REA CONTRACTING | SF RIVER PIT | SC623 | DALLAS, NC | 1.1 | 0.5 | 98 |
| SUPERIOR SAND | | SC546 | NICHOLS, SC | 0.1 | 0.1 | 100 |
| STARRETTE TRUCKING | Starrette Pit | SC616 | AUGUSTA, GA | 0.8 | 2.9 | 96 |
| SUMTER COUNTY SAND | Glasscock | SC545 | SUMTER, SC | 0.0 | 0.7 | 99 |
| THOMAS SAND | | SC547 | BLACKSBURG, SC | 0.7 | 0.3 | 99 |
| WILLIAMS C&D LANDFILL | | SC610 | GRANITEVILLE, SC | 0.4 | 2.1 | 97 |

NOTES

- NOTE 1: THIS QUALIFICATION IS NOT INTENDED TO ELIMINATE GRADATION CONTROL AND/OR CONTAMINATION CONTROL AT THE JOBSITE.
- NOTE 2: BLENDING OF SANDS IS APPROVED ONLY IF THE COMPOSITE BLEND OF THE SANDS MEETS GRADATION REQUIREMENTS. ANY COMBINATION OF THE QUALIFIED SAND IS APPROVED AS LONG AS GRADATION REQUIREMENTS ARE MET AND THE CONCRETE DISPLAYS SATISFACTORY WORKABILITY, ETC. ANY QUESTIONS REGARDING BLENDING SHOULD BE DIRECTED TO THE SCDOT OFFICE OF MATERIALS AND RESEARCH.
- NOTE 3: COLORIMETRIC TEST EXCEEDING COLOR PLATE 3 HAS BEEN TESTED AND SHALL NOT BE USED FROM THIS SOURCE.
- NOTE 4: COLORIMETRIC TEST OF COLOR PLATE 4 HAS BEEN TESTED AND QUALIFIED FROM THIS SOURCE.
- NOTE 5: COLORIMETRIC TEST OF COLOR PLATE 5 HAS BEEN TESTED AND QUALIFIED FROM THIS SOURCE.
- NOTE 6: SOUNDNESS RESULTS ARE MADE ON ALTERNATE YEARS. THESE RESULTS ARE BASED ON PREVIOUS YEAR'S TESTS.
- NOTE 7: DOES NOT MEET FA-10 GRADATION BUT MEETS FA-10M GRADATION FOR MANUFACTURED SAND.

LEGEND

| | | | | | |
|---|-------------|---|--------------|---|----------|
| B | BANKED | M | MANUFACTURED | R | RIVER |
| D | DREDGED | N | NATURAL | S | SCREENED |
| L | LIGHTWEIGHT | P | PROCESSED | W | WASHED |

SCDOT CONTACT PERSON: G. MICHAEL LOCKMAN.
 SCDOT OFFICE OF MATERIALS AND RESEARCH
 PO BOX 191
 COLUMBIA, SC 29202
 (803) 737-6692 FAX: (803) 737-6649

SOUTH CAROLINA DEPARTMENT OF TRANSPORTATION
QUALIFIED COARSE AGGREGATE SOURCES

NOTICE: THE DATA PROVIDED HEREIN IS FOR INFORMATION ONLY. MATERIALS CHARACTERISTICS WILL VARY DURING PRODUCTION. USING SOURCES LISTED ON THIS QUALIFIED PRODUCTS LIST DOES NOT RELIEVE THE CONTRACTOR OF RESPONSIBILITY FOR PROVIDING MATERIALS THAT CONFORM TO THE APPLICABLE SPECIFICATIONS FOR END USE.

| SUPPLIER (SOURCE NAME) LOCATION | SCDOT NO. | LA ABRA LOSS % | | ABSORPTION % | SPECIFIC GRAVITY | | | SOUNDNESS % LOSS at 5 CYCLES | | | SAND EQUIV ALENT | NOTES |
|---|-----------|--|----|-----------------|------------------|--------------------|------|---------------------------------|------------------|-----------------|------------------------|------------|
| | | B | C | | BLK. DRY | BLK. APP ARE | NT | 1 1/2 to 3/4 | 3/4 TO 3/8 | 3/8 TO #4 | | |
| AGGREGATE USA | | | | | | | | | | | | |
| Appling, Ga. (Dogwood Quarry) | SC146 | 42 | 46 | 0.7 | 2.61 | 2.63 | 2.67 | 0.5 | 0.3 | 0.3 | 75 | C,Gr |
| Macon, Ga. (Hitchcock Quarry) | SC171 | 19 | 24 | 0.6 | 2.67 | 2.68 | 2.71 | 0.1 | 0.2 | 0.6 | 59 | 1,C,Gr |
| Sparta, Ga. | SC210 | 45 | 47 | 0.6 | 2.59 | 2.61 | 2.64 | 0.3 | 0.2 | 0.3 | 72 | 4,C,Gr |
| Savannah, Ga. (Savannah Vending Yard) | SC213 | Transfer Stockpiles from Aggregates USA Macon Quarry | | | | | | | | | | |
| Springfield, Ga. (Springfield Sales Yard) | SC193 | Transfer Stockpiles from Aggregates USA Macon Quarry | | | | | | | | | | |
| APAC MID-SOUTH | | | | | | | | | | | | |
| Warren County Quarry | SC211 | 35 | 42 | 1.1 | 2.62 | 2.65 | 2.69 | 1.5 | 0.8 | 0.8 | 66 | C,Gr |
| ATLANTIC COAST MATERIALS | | | | | | | | | | | | |
| ACM, Bayside, Canada (information only) | - | 15 | 20 | 0.6 | 2.70 | 2.71 | 2.74 | - | 0.2 | 0.4 | - | C,Gr. |
| ATLANTIC COAST MATERIALS | | | | | | | | | | | | |
| Savannah, Ga. (East Coast Terminal) | SC212 | Transfer Stockpiles from Atlantic Coast Materials, Bayside, NB, Canada | | | | | | | | | | |
| BLUEGRASS MATERIALS COMPANY, LLC | | | | | | | | | | | | |
| Trenton, SC (Edgefield Quarry) | SC216 | 48 | 51 | 1.3 | 2.55 | 2.59 | 2.64 | 1.1 | 0.9 | 1.07 | 76 | C,Gr |
| BUCKHORN MATERIALS, LLC | | | | | | | | | | | | |
| Jefferson, SC (Lynches River Q) | SC191 | 43 | 42 | 0.8 | 2.61 | 2.63 | 2.66 | 0.1 | 0.9 | 4.2 | 96 | 1,C,Gr |
| CAROLINA STALITE COMPANY | | | | | | | | | | | | |
| Albemarle, NC (Aquadale) | SC102 | 32 | 28 | 4.8 | 1.38 | 1.44 | 1.48 | 0.4 | 0.0 | 3.7 | -- | 1,LW |
| Salisbury, NC (Gold Hill) | SC103 | 32 | 27 | 4.2 | 1.37 | 1.43 | 1.46 | 0.1 | 0.2 | 0.2 | -- | 1,LW |
| CHARLESTON MILL SERVICE | | | | | | | | | | | | |
| Huger, SC | SC178 | 17 | 17 | 1.2 | 3.61 | 3.66 | 3.78 | 0.4 | 2.3 | 3.3 | 82 | 2,5,MFG-SS |
| CONRAD YELVINGTON DIST, INC | | | | | | | | | | | | |
| Hardeeville, SC | SC196 | Transfer stockpiles from Martin Marietta Augusta and Camak Quarries. | | | | | | | | | | |
| HANSON AGGREGATES | | | | | | | | | | | | |
| Anderson, SC | SC105 | 46 | 53 | 0.8 | 2.65 | 2.67 | 2.70 | 0.1 | 0.1 | 0.1 | 61 | 1,C,Gr |
| Athens, Ga. | SC173 | 46 | 49 | 0.8 | 2.66 | 2.68 | 2.72 | 0.4 | 0.4 | 0.9 | 75 | 1,C,Gr-Gn |
| Bennettsville, SC (Marlboro) | SC106 | 56 | 51 | 0.6 | 2.61 | 2.62 | 2.65 | 0.3 | 0.1 | 0.3 | -- | 1,G,Q |

QUALIFIED PRODUCTS LIST 2

For Class Purposes Only
Page 2 of 3

**SOUTH CAROLINA DEPARTMENT OF TRANSPORTATION
QUALIFIED COARSE AGGREGATE SOURCES**

| SUPPLIER (SOURCE NAME) LOCATION | SCDOT NO. | LA ABRA LOSS % | | ABSORPTION % | SPECIFIC GRAVITY | | SOUNDESS % LOSS at 5 CYCLES | | | SAND EQUIV ALENT | NOTES | |
|--|-----------|---|----|-----------------|---------------------|-------------|--------------------------------|-----------------------|------------------|------------------------|-------|-----------------|
| | | B | C | | BL K. DR Y | BLK. SSD | APP ARE NT | 1 1/2 To 3/4 | 3/4 To 3/8 | | | 3/8 To #4 |
| <p>The following sources are qualified only for use in Non-Reinforced Concrete, Graded Aggregate Base Course, Asphalt Aggregate Base Course, Asphalt Intermediate Course, Asphalt Surface Type C and Type D Course and Pipe Bed Material.</p> | | | | | | | | | | | | |
| GRAND STRAND AGGREGATES | | | | | | | | | | | | |
| Loris, SC (Goretown Mine) | SC101 | 35 | 48 | 4.2 | 2.31 | 2.41 | 2.56 | 2.4 | 4.1 | 3.1 | 55 | 1,C,ML |
| MARTIN MARIETTA AGGREGATES | | | | | | | | | | | | |
| Georgetown, SC (Terminal) | SC127 | Transfer Stockpile from Bahamas (BA 348) Quarry | | | | | | | | | | |
| Jamestown, SC (Georgetown II) | SC129 | 33 | 32 | 4.0 | 2.37 | 2.46 | 2.62 | 4.1 | 4.9 | 2.5 | -- | 1,C,ML |
| Bahamas Islands (BA 348) (information only) ** | | 32 | 34 | 3.8 | 2.32 | 2.41 | 2.55 | | 12.8 | 19.6 | -- | 1,4,C,ML |
| WAKE STONE CORPORATION | | | | | | | | | | | | |
| Longs, SC | SC170 | 51 | 50 | 3.2 | 2.38 | 2.46 | 2.58 | 2.4 | 2.5 | 2.6 | 74 | 1,C,ML |
| <p>The following sources are qualified only for use in Graded Aggregate Base Course, Asphalt Aggregate Base Course, Asphalt Intermediate Course and Asphalt Surface Type D Course.</p> | | | | | | | | | | | | |
| MARTIN MARIETTA AGGREGATES | | | | | | | | | | | | |
| Eutawville, SC (Berkeley) | SC125 | 46 | 43 | 8.3 | 2.11 | 2.29 | 2.56 | 60.4 | 38.5 | 41.5 | -- | 1,C,ML |
| <p>The following sources are qualified only for use in Graded Aggregate Base , Pipe Bed Material and Rip Rap</p> | | | | | | | | | | | | |
| INMAN STONE, INC. | | | | | | | | | | | | |
| Inman, SC | SC115 | 50 | 45 | 0.8 | 2.71 | 2.73 | 2.77 | 0.2 | 0.5 | 1.4 | 72 | 1,C,Gr |
| OCONEE COUNTY ROCK | | | | | | | | | | | | |
| Walhalla, SC (Oconee Cty. Rock Quarry) | SC186 | 64 | 66 | 0.8 | 2.59 | 2.61 | 2.64 | 0.5 | 0.2 | 0.5 | 74 | 1,CGr |

SOUTH CAROLINA DEPARTMENT OF TRANSPORTATION
QUALIFIED COARSE AGGREGATE SOURCES

| The following sources are qualified only for use as riprap stone | | | | | | | | | | | | |
|--|-------|----|----|-----|------|------|------|-----|-----|-----|----|----------|
| HANSON AGGREGATES | | | | | | | | | | | | |
| Greer, SC (Pelham) | SC168 | 79 | 80 | 1.6 | 2.60 | 2.64 | 2.72 | 1.2 | 0.5 | 0.5 | -- | 1,7,C,Gr |

NOTES*

- NOTE 1: Soundness tests are made on alternate years. These results are based on previous year's tests.
 - NOTE 2: Qualified only for use in Graded Aggregate Base.
 - NOTE 3: Qualified for use in Class B Concrete, Graded Aggregate Base Course, Asphalt Aggregate Base Course, Asphalt Concrete Intermediate Course and Asphalt Surface Type D.
 - NOTE 4: Stone from this source may be loaded from yards other than the quarry.
 - NOTE 5: Qualified on a job to job basis per Standard Specification Subsection 401.03(d).
 - NOTE 6: Qualified only for use in aggregate courses that will be exposed and not overlaid with additional pavement course.
 - NOTE 7: Qualified only for use as riprap stone.
 - NOTE 8: Sources will not be permitted in Asphalt Surface Types A and B Courses, Asphalt Intermediate Type A Course and Open Graded Friction Course.
- * If no restrictive numerical notes are listed in note column, the aggregate may be used in all applications if not restricted by these notes, special provisions, plans and/or specifications.
- ** Materials from quarries with no SCDOT no. or marked for information only, are to be used from sales yard or terminals only.

LEGEND

| | | | | | |
|----|------------------|-----|-----------------------|-----|------------|
| C | Crushed | L | Limestone | Q | Quartzite |
| ML | Marine Limestone | LW | Lightweight Aggregate | Sch | Schist |
| G | Gravel | M | Marble | Sh | Shale |
| Gn | Gneiss | MFG | Manufactured | SS | Steel Slag |
| Gr | Granite | NSS | Non-Steel Slag | | |

SCDOT CONTACT PERSON: G. MICHAEL LOCKMAN
SCDOT OFFICE OF MATERIALS AND RESEARCH
PO BOX 191
COLUMBIA, SC 29202
(803) 737-6692 FAX: (803) 737-6649

SOUTH CAROLINA DEPARTMENT OF TRANSPORTATION

Qualified Product List for Fly Ash for Use in Portland Cement Concrete

| <u>Supplier</u> | <u>Type</u> | <u>Source Location</u> | <u>Producer Code</u> |
|--|-------------|---|----------------------|
| Ash Venture, LLC 188 Somerfield Ct., Suite 101 Roanoke, VA 24019 Bryan Mckenzie 601-299-2459 | F | Central Power and Light 1514 Dunnaway Rd Roxboro, NC 27573 | PCCFA035 |
| | F | Cliffside Steam Station Cliffside, NC | PCCFA037 |
| Boral Materials Technologies, Inc. 45 NE Loop 410 Suite 700 San Antonio, TX 78216 Melissa Garcia 1-210-348-4069 | F | Georgia Power Bowen Plant Taylorsville, GA | PCCFA038 |
| | F | Sandow Mine Power Plant Rockdale, TX "MICRON 3" | PCCFA039 |
| | C | Scherer Plant Juliette, GA | PCCFA040 |
| | F | JEA St. John River Park Plant 11201 New Berlin RD Jacksonville, FL 32226 | PCCFA041 |
| | F | Georgia Power Plant Wansley Franklin, GA | PCCFA042 |
| The SEFA Group 217 Cedar Rd. Lexington, SC 29073 Bert Nunn / Gary Sheaff 803-520-9001 bnunn@sefagroup.com | F | Santee-Cooper Cross Station Pineville, SC | PCCFA043 |
| | F | Santee-Cooper Winyah Station Georgetown, SC | PCCFA044 |
| | F | SCE&G McMeekin Station Columbia, SC | PCCFA045 |
| | F | Buck Station STAR 1555 Dukeville Rd Salisbury, NC 28146 | PCCFA056 |
| | F | HF Lee Station STAR 1594 Blackjack Church Rd Goldsboro, NC 27530 | PCCFA057 |
| | F | Cape Fear Fly Ash 2220 Corinth Rd Moncure, NC | PCCFA058 |
| | F | Duke Power Belews Creek Station Belews Creek, NC | PCCFA059 |
| | F | Dominion Energy Williams Station 2242 Bushy Park Rd Goose Creek, SC 29445 | PCCFA061 |
| Headwaters Resources 10701 S. River Front Pkwy., Suite 300 South Jordan, UT 84095 Doug Gruber 1-850-582-7324 | C | Source MR-205 Labadie Power Plant Labadie, MO | PCCFA046 |
| | C | Source MR-267 Rush Island Plant Festus, MO | PCCFA047 |

| | | | |
|---|---|--|----------|
| Headwaters Resources – Continued | C | Miller Power Plant Units 3 & 4 Birmingham, AL | PCCFA048 |
| Mineral Resource Technologies MRT A CEMEX Company 929 Gessner Rd, Suite 1900 Houston, TX 77024 Oscar Jaramillo 1-713-722-6088 | C | Source MR-47 Grand River Dam Authority GRDA Coal Fired Generating Station Chouteau, OK | PCCFA049 |
| | F | Eren Enerji Elektrik Uretim A.S. Catalagzi, Zonguldak, Turkey | PCCFA050 |
| Charah, LLC 12601 Plantside Dr. Louisville, KY 40299 David Weber 1-502-377-6570 dweber@charah.com | F | Source MR-267 Petersburg Generating Station Boilers 3 & 4 Petersburg, IN | PCCFA051 |
| Separation Technologies, LLC (Titan America Business) 11000 NW 121 st Way Medley, FL 33178 Jorge Tercero 305-588-9591 | F | Separation Technologies, LLC 1400 Wago Rd. York Haven, PA 17370 | PCCFA052 |
| | F | Separation Technologies, LLC 1000 Brandon Shores Rd Baltimore, MD 21226 | PCCFA053 |
| Spartan Materials 5221 Creek Rd. Cincinnati, OH 45242 Geoffrey Mather 513-800-7690 1-513-266-8882 gmather@spartanmaterials.com | F | Adani Power Plant Gujarat, India | PCCFA054 |
| Waste Management / Fly Ash Direct 4228 Airport Rd Cincinnati, OH 45228 Doug Burry 1-216-401-7266 dburry@wm.com | F | AEP John Amos Power Plant 1350 Winfield Rd. Winfield, WV 26213 | PCCFA055 |
| JSW Energy Limited Village Nandiwade, Post Jaigad Maharashtra 415614, India Ashish Musale 91 2357 242501-505 Ext. 1572 ashish.musale@jsw.in | F | JSW Energy Limited Jaigarh Village, Ratnagiri District Maharashtra, India | PCCFA060 |

SCDOT CONTACT PERSON:

Caleb Gunter
 Structural Materials Engineer
 SCDOT Office of Materials and Research
 PO Box 191
 Columbia, SC 29201
 Telephone: (803) 737-6694
 Email: guntercb@scdot.org

South Carolina
 Department of Transportation
 Qualified Air Entraining and
 Chemical Admixtures for Concrete

| PRODUCER | TRADE NAME | TYPE | CODE | RECOMMENDED DOSAGE RATE | NTPEP NUMBER | NOTE | |
|--|---|----------------|-------------|-------------------------|-------------------|-------------------|--|
| Axim Concrete Technologies P. O. Box 234 8282 Middlebranch Road Middlebranch, Ohio 44652 Nate Artman Nathaniel.artman@essroc.com 330-966-0444 ext. 2021 | Catexol AE 260 | AEA | AEA | 0.1 to 6 | CADD(2009)-15 | | |
| | Catexol AE 360 | AEA | AEA | 0.1 to 6 | CADD(2009)-16 | | |
| | Catexol 800N | A | WRA | 2 to 6 | CADD(2009)-12 | | |
| | Catexol 1000N | A | WRA | 1.5 to 5 | CADD(2009)-13 | | |
| | Catexol 3000GP | A | WRA/WRA-MR | 2 to 20 | CADD(2009)-21 | | |
| | Catexol 3500 N | A | WRA/WRA-MR | 3 to 20 | CADD(2009)-20 | | |
| | Catexol Hydrosense | A & F | WRA/WRA-HR | 2 to 15 | CADD(2009)-22 | | |
| | Superflux 2100 PC | A & F | WRA/WRA-HR | 3 to 30 | CADD(2009)-33 | | |
| | Catexol 2000Ni | A & G | WRA/WRAR-HR | 3 to 24 | CADD(2009)-19 | | |
| | Allegro 122 | A & F | WRA/WRA-HR | 4 to 30 | CADD(2009)-26 | | |
| | Duraflux 33 | A & F | WRA/WRA-HR | 1 to 8 | CADD(2009)-27 | | |
| | Duraflux 66 | A & F | WRA/WRA-HR | 1 to 8 | CADD(2009)-30 | | |
| | Duraflux 77 | A & F | WRA/WRA-HR | 1 to 6 | CADD(2009)-31 | | |
| | SuperFlux 2000 PC | A & F | WRA-WRA-HR | 3 to 30 | CADD(2009)-32 | | |
| | Catexol 2000 RHE | C & E | A/WRA-A | 5 to 60 | CADD(2009)-25 | | |
| | Catexol 1000R | D | WRA-R | 1.5 to 4 | CADD(2009)-14 | | |
| | Catexol 1000 SP-MN | F | WRA-HR | 10 to 40 | CADD(2009)-23 | | |
| | Euclid Chemical Company 19218 Redwood Road Cleveland Ohio 44110 1-216-692-8381 Attn. Christopher Balsat Email address: cbalsat@euclidchemical.com | Plastol 341 | A & F | WRA/WRA-HR | 2 to 10 | CADD(2010)-02-040 | |
| | | Accelguard 80 | C & E | A/WRA-A | 12 to 90 | CADD(2010)-01-024 | |
| | | Accelguard NCA | C & E | A/WRA-A | 12 to 75 | CADD(2010)-01-022 | |
| Eucon Air 30 | | AEA | AEA | 0.5 to 1 | CADD(2010)-01-047 | 1 | |
| Eucon Air 40 | | AEA | AEA | 0.5 to 1 | CADD(2010)-01-048 | 1 | |
| Eucon LR | | A | WRA | 3 to 10 | CADD(2010)-01-026 | | |
| Eucon LW | | A | WRA | 3 to 6 | CADD(2010)-01-028 | | |
| Eucon NW | | A | WRA | 2 to 6 | CADD(2010)-01-020 | | |
| Eucon NR | | A & D | WRA/WRA-R | 3 to 5 | CADD(2010)-01-049 | | |
| Eucon SPC | | A & F | WRA-WRA-HR | 3 to 12 | CADD(2010)-01-016 | 9 | |
| Eucon SPJ | | A & F | WRA/WRA-HR | 4 to 7 | CADD(2010)-01-015 | 9 | |
| Eucon X15 | | A & F | WRA/WRA-HR | 3 to 10 | CADD(2010)-01-030 | | |
| Eucon X20 | | A & F | WRA/WRA-MR | 3 to 15 | CADD-2011-01-018 | | |
| Eucon AcN | | C & E | A/WRA-A | 20 to 60 | CADD-2010-01-029 | 14 | |
| Eucon AcN 200 | | C & E | A/WRA-A | 10 to 60 | CADD-2011-01-020 | 14 | |
| Eucon LR | | D | WRA-R | 3 to 10 | CADD(2010)-01-026 | | |
| Eucon TR | | D | WRA-R | 3 to 6 | CADD-2011-01-021 | | |
| Eucon W.O. | | D | WRA-R | 4 to 16 | CADD-2011-01-017 | | |
| Eucon SP | | F | WRA-HR | 12 | CADD-2011-01-016 | 2 & 7 | |
| Eucon RD-2 | | G | WRAR-HR | 6 to 10 | CADD-2011-01-014 | 2 & 7 | |
| Euco Air-Mix | | AEA | AEA | 0.5 to 1 | CADD-2011-01-012 | 1, 6 | |
| Eucon AEA-92 | | AEA | AEA | 0.5 to 1 | CADD(2010)-01-021 | 1 | |
| Eucon AEA 92S | | AEA | AEA | 0.5 to 2 | CADD(2010)-01-034 | | |
| Euco Air-Mix 200 | | AEA | AEA | 0.5 to 1 | CADD(2008)-10 | 1 | |
| Euco Air-Mix 250 | | AEA | AEA | 0.75 to 1.5 | CADD(2008)-11 | 1 | |
| Eucon A+ | | A | WRA | 3 to 8 | CADD-2011-01-015 | | |
| Eucon Pro-Finish | | A | WRA | 3 to 10 | CADD(2009)-01 | | |
| Eucon MR | | A | WRA | 4 to 10 | CADD(2008)-13 | | |
| Eucon WR | | A | WRA | 4 | CADD(2010)-01-027 | | |
| Eucon WR-75 | | A | WRA | 2 to 3 | CADD(2010)-01-014 | | |
| Eucon WR-91 | | A | WRA | 3.5 to 6 | CADD(2010)-01-031 | | |
| Eucon MRX | | A & F | WRA/WRA-HR | 3 to 12 | CADD(2009)-02 | | |
| Eucon 37 | | A & F | WRA/WRA-HR | 10 to 16 | CADD(2010)-01-019 | 2 | |
| Plastol Ultra 109 | | A & F | WRA/WRA-HR | 2 to 12 | CADD(2010)-02-043 | | |
| Plastol 341S | | A & F | WRA/WRA-HR | 2 to 10 | CADD(2008)16 | | |
| Plastol 6200 EXT | | A & F | WRA/WRA-HR | 3 to 12 | CADD(2010)-01-046 | | |
| Euco Accelguard 80 | | C & E | A/WRA-A | 16 to 32 | CADD(2010)-01-024 | | |
| Eucon DS | | D | WRA-R | 4 to 16 | CADD(2010)-01-050 | | |
| Eucon Retarder 75 | | D | WRA-R | 3 to 5 | CADD(2010)-01-017 | | |
| Eucon Retarder 100 | | D | WRA-R | 2 to 6 | CADD(2010)-01-045 | | |
| Eucon WR | D | WRA-R | 12 | CADD(2010)-01-027 | | | |
| Eucon 1037 | F | WRA-HR | 6 to 25 | CADD(2010)-01-018 | 2, 7 | | |
| Plastol 5000 | F | WRA-HR | 3 to 10 | CADD-2011-01-022 | | | |
| Plastol 5500 | F | WRA-HR | 3 to 8 | CADD(2010)-01-023 | | | |

| Type | Code | Description |
|--------|---------|-----------------------------------|
| Type A | WRA | Normal Water Reducer |
| Type C | A | Accelerator |
| Type D | WRA-R | Water Reducer Retarder |
| Type E | WRA-A | Water Reducer Accelerator |
| Type F | WRA-HR | High Range Water Reducer |
| Type G | WRAR-HR | High Range Water Reducer Retarder |

NOTES

Dosage rates refer to either one bag or 100 lbs of cementitious material

All dosages shown are producer's recommended dosage rates.

Note 1: Adjustment should be made in the recommended dosage rates to obtain the desired amount of entrained air (4.5% +/- 1.5%). The amount required must be determined by test.

Note 2: This agent may be used with a Type A or Type D admixture if approved by the producer, at a rate to obtain the desired concrete workability and slump. Also, it may be added a second or third time to return the concrete to a workable slump.

Note 3: Normally as an air entraining agent, only a neutralized vinsol resin should be used with this product.

Note 4: 2oz/100 lbs below 65 degrees Fahrenheit, 3oz/100 lbs 65 degrees Fahrenheit to 85 degrees Fahrenheit, 4oz/100 lbs above 85 degrees Fahrenheit.

Note 5: This is a dry weight and not a liquid measurement and is non-chloride.

Note 6: This is a known neutralized vinsol resin.

Note 7: This agent may be re-dosed twice. The amount may be varied to get the desired results.

Note 8: This agent may be used with Type C or E admixture, if approved by the manufacturer.

Note 9: The agent to be remixed after long storage periods.

Note 10: Shelf life is one year.

Note 11: Shelf life is nine months.

Note 12: Approved by Policy 32 as a Mixer Wash Water Stabilizer.

Note 13: This product contains calcium chloride.

Note 14: Where water reduction is not required, less amounts may be used to aid in acceleration as required for job situations.

Note 15: Mid range Water Reducer.

SCDOT CONTACT PERSON:

Caleb Gunter

Structural Materials Engineer

SCDOT Office of Materials and Research

PO Box 191

Columbia, SC 29201

Telephone: (803) 737-6694

Email: guntercb@scdot.org

SOUTH CAROLINA DEPARTMENT OF TRANSPORTATION

Qualified Portland Cement and Non-Steel Slag Manufacturers

The following is a list of Portland Cement Manufacturers who have satisfied the requirements established in the Department's "Policy for Portland Cement and Non-Steel Slag Manufacturers." All Trade Names are registered Trademarks of the appropriate company.

| Sales Office | Trade Name | Type | Mill and Transfer Silo Terminals |
|--|-------------------------------|----------------|--|
| Argos Cement USA P.O. Box 326 Harleyville, SC 29448 800-845-2771 | Magnolia (bulk) | I II III | Harleyville Plant at Harleyville, SC |
| | (bagged) | I | |
| | Asia Cement Corp. | I | |
| *Bruce Walker (803) 238-7705 | Titan Cement (bulk) | I | Kamari, Plant at Eleuis, Greece Lafarge Terminal Charleston, SC |
| | Heracles (bulk) | I | Mylaki Plant, Greece Lafarge Terminal Charleston, SC |
| | Cementos Del Caribe (bulk) | I | Barranquilla Plant & Cartagena Plant Colombia, S.A. Port Royal Terminal Port Royal, SC |
| | Vencemos (bulk) | I II | Vencemos Plant at Venezuela, S.A. |
| Argos Cement USA 2520 Paul Street Atlanta, GA 30318 | Magnolia (bulk) | I III | Atlanta Plant at Atlanta, GA Lafarge Terminal Charleston, SC |
| | (bagged) | I | |
| Argos Cement USA PO Box 182 Calera, AL | Magnolia (bulk) | I, II | Roberta Plant at Calera, AL. |
| | (bagged) | I, II | |

***Bruce Walker is the contact person for all locations.**

Port Royal Cement

2200 Burnett Blvd
Wilmington, NC 28402
Telephone: 912-238-3108
Fax: 912-238-0511
Ivan Radi
Cell: 912-659-2419

I

Barranquilla Plant &
Cartagena Plant
Colombia, SA
Terminal Silos at
Savannah, GA
Terminal Silos at
Wilmington, NC

Notes:

- (1) All trade names are registered trademarks of the appropriate company.
- (2) This qualified product list is for general product qualification and does not guarantee performance of a particular shipment.
- (3) All pre-qualified sources (manufacturers) must continue to comply with the policy for Portland Cement Inspections. The delivery of cement used in SCDOT projects must be accompanied with a delivery ticket and certification stating that the cement is guaranteed to meet SCDOT specifications.

SCDOT CONTACT PERSON:

Caleb Gunter
Structural Materials Engineer
SCDOT Office of Materials and Research
PO Box 191
Columbia, SC 29201
Telephone: (803) 737-6694
Email: guntercb@scdot.org

SOUTH CAROLINA DEPARTMENT OF TRANSPORTATION

Qualified Spray-On/Brush-On Surface Coatings for Concrete Finish

**SPRAY-ON
Non-Cementitious**

Solventborne

Spray-on Coatings must meet South Carolina Department of Transportation Standard Specification for Highway Construction.

Vinyl Toluene Acrylate Copolymer

| Source | Trade Name | Note |
|--|---|--|
| Textured Coatings of America, Inc. 2422 East 15th Street Panama City, Florida 32405 Sales: 1-800-454-0340 1-904-769-0347 Mr. Richard Barnes | XL-70 Bridge-Coat Curing Compound | Note 1 Note 5 |
| Proko Industries 501 S. Foote Street Cambridge City, IN 47327 1-800-423-8341 - Ext. 31 Ms. Ilene A. Waite | Triko-Plex Curing Compound | Note 4 Lower pH \leq 7 for surface alkalinity |
| Sherwin-Williams 1415 East Bessemer Ave Greensboro, NC 27405 Mr. Sid Oakes Cell: (336) 324-0614 Email: sid.oakes@sherwin.com | *H & C Silicone Acrylic Concrete Stain **UltraCrete | Note 3 Note 2 |
| VEXCOM Chemicals 7240 State Road Philadelphia, PA 19135 Telephone: (888)-VEXCON1 (839-2661) Mr. Clifford platt | Certi-Vex Enviosmooth VOC | Note 1 |

*Also under the name "Concrete Sealer, B97-Series".

**Also under the name "DOT Solvent Texture Coating, B97-Series".

NOTES:

1. Concrete does not have to be cured beyond the set time before applying the coating. The finish coat may be used in lieu of concrete wet cure or a curing compound. For delayed application of coating see Note 5.
2. Concrete must cure a minimum of 7 days before application.
3. Concrete must cure a minimum of 14 days before application.
4. Concrete must cure a minimum of 28 days before application.
5. For waiting periods as required by Notes 2, 3, and 4, or delay of coating application (Note 1) at option of the Contractor, the concrete shall be cured for at least 4 days by wet cure methods as described in Section 702.4.11 of the Standard Specifications or by means of a dissipating membrane curing compound that is clear (with or without fugitive dye) and restricted to resin (non-wax), known as AASHTO M 148 Type 1D, Class B.

SCDOT CONTACT PERSON:

Caleb Gunter
Structural Materials Engineer
SCDOT Office of Materials and Research
PO Box 191
Columbia, SC 29201
Telephone: (803) 737-6694
Email: guntercb@scdot.org



Qualified Product Listing for:
Bridge Deck Waterproofing Membrane Type I
for use under HMA overlays

| Source | Product |
|--|--|
| Carlisle Coatings & Waterproofing 900 Hensley Lane Wylie, TX 75098 972-442-6545 phone 800-527-7092 toll free Fax 972-442-0076 | CCW-711-70 Primer CCW-702 (When pavement surface is 40 degrees F and rising) |
| Crafco Inc. 6165 W. Detroit St. Chandler, AZ 85226 (602)276-0476 | Pave Prep |
| Polyguard Products, Inc. PO Box 755 Ennis, TX 75120 (800)541-4994 | Polyguard 665 Primer: 650 RC - 650 Mastic Polyguard NW-75 Primer: 650 RC - 650 Mastic |
| W.R. Meadows, Inc. PO Box 543 Elgin, IL 60121 (330)896-5900 | MELDEK Waterproofing Membrane |

SCDOT Contact:
Luke Gibson, P.E.
Pavement Design Engineer
Office of Materials and Research
P.O. Box 191
Columbia, SC 29202-0191
Phone: (803)737-6702
Fax: (803)737-6649
E-mail: gibsonlw@scdot.org

SOUTH CAROLINA DEPARTMENT OF TRANSPORTATION

Qualified Cold Applied Sealants for Bridge Joints

Manufacturer

Product

Polymeric Elastomeric Two Component Sealant

W. R. Meadows of Georgia
100 Riverside Drive
Cartersville, GA 30120
1-770-386-6440
1-800-342-5976
Jim Nelson

SOF-SEAL 224
No Primer Necessary

Lion Oil Company
Protective Coatings Department
El Dorado Refinery
1000 McHenry (Physical Address)
El Dorado, AR 71730
1-800-643-1506

Elastomeric Sealant
Lion D200 (Summer Grade)
Lion D200 (Winter Grade)

Lion Oil Company
Protective Coatings Department
El Dorado Refinery
PO Box 7005 (Mailing Address)
El Dorado, AR 71731-7005
1-800-643-1506

Sika Corporation
3778 La Vista Road
Suite 300
Tucker, GA 30084
1-800-933-SIKS
FAX: (404) 315-0117

Sikaflex-2C/SL
Color - Precast Gray

Pecora Corporation
165 Wambold Road
Harleysville, PA 19438
1-215-799-7557
1-267-816-7720
Glen Murphy
FAX: (215) 721-0286
www.pecora.com

NR 200
Primer 200

BASF Corporation
Master Builders Solutions
889 Valley Park Drive
Shakopee, MN 55379
1-800-433-9517
Zach Duggan – Brian Spencer
www.master-builders-solutions.basf.us

MasterSeal NP 2
MasterSeal SL2

Manufacturer

Product

Silicone Sealant

Dow Corning Corporation
1225 Northmeadow Parkway
Suite 104
Roswell, GA 30076
Telephone: (770) 751-7979
FAX: (770) 343-8015

902 RCS (Self-Level)

BASF
WATSON BOWMAN ACME
95 Pineview Drive
Amherst, NY 14228
1-800-677-4922 ext 5458
Cell: 716-316-6022
Fax: 1-716-691-9239
Michael Ferro

Wabo Crete SiliconeSeal System

Pecora Corporation
165 Wambold Road
Harleysville, PA 19438
1-215-799-7557
1-267-816-7720
Glen Murphy
FAX: (215) 721-0286
www.pecora.com

Pecora 322 FC Faster Cure
SiliconeSeal

SCDOT CONTACT PERSON:

Caleb Gunter

Structural Materials Engineer
SCDOT Office of Materials and Research
PO Box 191
Columbia, SC 29201
Telephone: (803) 737-6694
Email: guntercb@scdot.org



SOUTH CAROLINA DEPARTMENT OF TRANSPORTATION

AUTHORIZED SUPPLIERS OF TYPE I(SM) SLAG-MODIFIED PORTLAND CEMENT

The following is a list of Type I(SM) Slag-Modified Portland Cement Suppliers who have satisfied the requirements established by the SCDOT as defined by Qualified Product Policy 18. Both cement and slag constituents in slag-modified cement must be from qualified sources listed on SCDOT qualified product list #6, "Authorized Portland Cement and Non-Steel Slag Manufacturers." All trade names are registered trademarks of the appropriate companies.

| Manufacturer | Trade Name | Type | Mill and Transfer Silo Terminals |
|--|------------|-------|-------------------------------------|
| Holcim (US) Inc. 1501 Main Street Suite 725 Columbia, SC 29201 Tel: (803) 252-5428 Fax: (803) 252-3862 Eddie Deaver edward.deaver@holcim.com | HolCem | I(SM) | Holly Hill Plant, Holly Hill, SC |

SCDOT Contact Person:

Caleb Gunter
 Structural Materials Engineer
 SCDOT Office of Materials and Research
 PO Box 191
 Columbia, SC 29201
 Telephone: (803) 737-6694
 Email: guntercb@scdot.org

SOUTH CAROLINA DEPARTMENT OF TRANSPORTATION
Rapid Patch Material for Concrete Pavement

| <u>Brand</u> | <u>Source</u> |
|--|--|
| Fast Set Cement Mix ProSpec Rapid Patch VR ProSpec Magna 100 ProSpec VO Repair Mortar | ProSpec American 8201 Arrowridge Blvd. Charlotte, NC 28273 (800) 738-1621 Michael Boenisch (704) 529-4272 |
| SonoPatch 100 | New south Construction Supply 951 Harbor Road West Columbia, SC 29169 (803) 791-8700 |
| Futura Patching Mix | W. R. Meadows of GA. PO Box 280 Austell, Georgia 30001 (800) 342-5976 Fax: (770) 941-5058 |
| Sikaset (1) SikaQuick 2500 (2) Roadway Patch 2000 | Sika Corporation 201 Polito Ave Lyndhurst, NJ 07071 (704) 905-5836 Jim Hadley |
| Road Patch II (with Acryl 60) | Thoro Systems Products 7800 NW 38th Street Miami, Florida 33166-6599 (803) 776-3363 |
| Hilti RM 800 PC | Hilti PO Box 21148 Tulsa, OK 74121 (800) 727-3427 Ext 7533 |
| Emaco T 415 and Emaco S88-CA ThoRoc 10-60 Rapid Mortar SET 45 | *BASF Building Systems, Inc. 23700 Chagrin Boulevard Cleveland, Ohio 44122 Brian Spencer 803-356-4952 803-873-2156 cell www.basf-buildingsystems.com |

*Formerly Degussa (as of 7-1-06)

Brand

Elephant Armor DOT

Source

GST International
3579 Westwind Blvd.
Santa Rosa, CA 95403
707-291-0808; Fax 707-527-6522
Thomas Martin

Unique High Performance Fast Set

Unique Paving Materials Corp.
3993 E. 93rd Street
Cleveland, OH 44105-4096
216-978-0504; Fax 216-341-8514
Josh Pemberton

SCDOT CONTACT PERSON:

Caleb Gunter

Structural Materials Engineer
SCDOT Office of Materials and Research
PO Box 191
Columbia, SC 29201
Telephone: (803) 737-6694
Email: guntercb@scdot.org

**South Carolina Department of Transportation
 Qualified Ready Mix Concrete Plants**

Plant names that appear on this list are qualified to furnish concrete to the department projects at the time of inspection.

The Project Engineer should assure the plant is in compliance to furnish the type concrete needed when contractor orders concrete. Plants that DID NOT comply with department's specifications at the time of inspection ARE NOT listed.

****Note: NRMCA CERTIFICATIONS MUST BE CURRENT AT THE TIME OF PROVIDING SERVICES TO SCDOT PROJECTS.**

| COUNTY/ STATE | COMPANY ADDRESS | LOCATION | CONTACT/ PHONE NUMBER | ** EXPIRATION DATE | NRMCA ID Number | SITE MANAGER P/S CODE |
|------------------|---|------------------------------------|----------------------------------|--------------------------|-----------------------|-----------------------------|
| 02 | Argos Ready Mix, LLC 201 Laney Walker Blvd. Augusta, GA 30901 | Aiken Plant 371 | John Fleischauer 706-823-4470 | 10/13/2013 | 13669 | RMCP192 |
| 02 | Argos Ready Mix LLC 201 Laney Walker Blvd. Augusta, GA 30901 | Jackson Plant 377 | John Fleishauer 706-823-4470 | 10/28/2012 | 12453 | RMCP193 |
| 02 | Argos Ready Mix LLC 201 Laney Walker Blvd. Augusta, GA 30901 | Jackson Portable Plant 381-2 | John Fleishauer 706-823-4470 | 2/14/2013 | 12725 | RMCP194 |
| 04 | American Concrete & Precast P. O. Box 4026 Anderson, SC 29622 | Anderson | Jamie Boulware 864-222-6868 | 7/29/2013 | 13459 | RMCP161 |
| 04 | Thomas Concrete 124 Moats Fowler Rd. Anderson, SC 29626 | Anderson Plant #4000 | Steve Tanner 864-225-1070 | 11/3/2012 | 12332 | RMCP004 |
| 04 | Cemex Old Pearman Dairy Rd. Anderson, SC | Anderson Plant 4644 | 864-224-8722 | 11/21/2013 | 13805 | RMCP131 |
| 04 | Century Concrete, LLC P. O. Box 2524 Greer, SC 29652 | Piedmont Plant 2 | Joey Stone 864-848-5545 | 6/11/2013 | 13200 | RMCP048 |
| 05 | Orangeburg Redi-Mix Co. PO Box 1683 Orangeburg, SC 29116 | Bamberg Plant 2 | J. C. Till 803-245-5363 | 9/29/2013 | 13682 | RMCP006 |

| COUNTY/ STATE | COMPANY ADDRESS | LOCATION | CONTACT/ PHONE NUMBER | ** EXPIRATION DATE | NRMCA ID Number | SITE MANAGER P/S CODE |
|------------------|---|--|---------------------------------------|--------------------------|-----------------------|-----------------------------|
| NC | Southern Concrete Materials PO Box 33038 Charlotte, NC 28283 | South Plant 32 Near prestress plt. | Joseph Leotaud 704-588-1641 | 8/20/2012 | 12238 | RMCP047 |
| NC | Thomas Concrete Co. 3701 North Graham St. Charlotte, NC 28206 | Gastonia Plant 514 | Vincent Washington 704-634-2534 | 5/14/2013 | 13117 | RMCP130 |

S.C.D.O.T. CONTACT PERSON:

JIM MCCABE
 SR. CONCRETE MATERIALS SUPERVISOR
 1406 SHOP ROAD
 COLUMBIA, S.C. 29201
 PHONE: (803) 737-6689
 FAX: (803) 737-6649
 Email: mccabejm@scdot.org

SOUTH CAROLINA DEPARTMENT OF TRANSPORTATION

Qualified Stabilizer Agents for Mixer Drum Wash Water

These products are qualified for holding a concrete truck overnight after it is empty and is not intended to hold concrete overnight.

| <u>Source</u> | <u>Product</u> |
|---|------------------------|
| Master Builders, Inc. 23700 Chagrin Blvd. Cleveland, Ohio 44122 Sales: (704) 845-2020 | Delvo (Product #1) |
| Cormix Construction Materials 471 Sessions St. Marietta, GA 30060 Sales: 1-800-777-5645 | ConSave (Product #2) |
| Fritz Chemical Company 500 Sam Huston Mesquite, TX 75149 1-800-955-1323 Fax: 1-972-289-8756 | Fritz-Pak (Product #3) |

Qualified Product #1

Delvo Stabilizer by Master Builders Inc. methods:

1. Add 115 liters of water to the ready-mix drum that has been emptied of all plastic concrete.
2. Turn drum in the direction to back up the wash water to the rear of the drum.
3. (a.) Dispense one liter of Delvo Stabilizer into the concrete wash water for overnight stabilization; or (b.) Dispense 2 liters of Delvo Stabilizer into the concrete wash water for over the weekend stabilization.
4. Turn drum in the direction to return stabilized concrete wash water to the front of the drum and mix at high speed for one (1) minute.
5. Turn drum in the direction to back up the stabilized wash water quickly to the rear of the drum for maximum fine cleaning.

6. Turn drum in the direction to return the stabilized concrete wash water to the front of the drum and mix at high speed for (1) minute and stop.
 7. If the drum is a truck mixer, park the truck for the night or weekend and cover the drum opening with a tarp to prevent addition of rain water, etc.
 8. The next day or after a weekend, batch the first concrete mix into the drum with 115 liters less mix water and proceed with normal concrete making and delivery procedures. This is necessary because the 115 liters of stabilized concrete wash water is used as mix water and is already in the mixer. It is necessary to subtract 115 liters from the water required by the batch chart to maintain the water-cement ratio and slump of the concrete for each mixer drum that was stabilized.
 9. A Batchman Log Sheet for each mixer shall be maintained and signed by responsible ready mix plant personnel indicating that the above methods have been strictly adhered to. A proper Batchman Log Sheet is the form "Delvo-5" by Master Builders. A copy of this form is attached at the approval policy.
-

Qualified Product #2

ConSave Stabilizer by Cormix Construction Materials:

Use the 9 methods exactly as shown for qualified product #1 above.

Qualified Product #3

Fritz-Pak Mini Delayed Set by Fritz Chemical Company

1. After discharging all plastic concrete, wash down rear drum fins and chutes. (Do not add water to drum).
2. Remove protective outer bag and add one container of Fritz-Pak Mini Delayed Set for each 16 hours of wash water stabilization required.
3. Add 115 to 190 liters of water to the mixer.
4. Mix wash water and Mini Delayed Set at high speed for 2 1/2 minutes.
5. Reverse drum to coat rear fin assembly. DO NOT DISCHARGE WASH WATER.

6. Mix wash water at high speed for an additional 2 1/2 minutes. (5 minutes total).
7. If mixer drum is truck mounted, park the truck and cover the drum opening in order to prevent the addition of rain water.
8. The next time concrete is batched, subtract the (actual gallons) added wash water and proceed with normal mixing procedures.
9. Maintain a Mixer Batch Log Sheet.

Contact Person for SCDOT:

Caleb Gunter
Structural Materials Engineer
SCDOT Office of Materials and Research
PO Box 191
Columbia, SC 29201
Telephone: (803) 737-6694
Email: guntercb@scdot.org

SOUTH CAROLINA DEPARTMENT OF TRANSPORTATION

Curing Compound for Concrete Structures

Curing Compounds on this qualified product list comply with Subsection 702.04 of the Standard Specifications.

The Resident Construction Engineer will accept shipment of curing compound by receiving the manufacturer's certificate of analysis and performance test results for products shown on this list.

| <u>SOURCE</u> | <u>TRADE NAME</u> | <u>NTPEP Code #</u> |
|--|---|----------------------------|
| W.R. Meadows of Georgia, Inc. 100 Riverside Drive Cartersville GA 301220 Sales: (800) 342-5976 Fax: (770) 941-5058 Mr. Jim Nelson | SEALTIGHT 1600 Type 2 Class A Wax Base | CCC-2011-02-003 |
| | SEALTIGHT 1100/1150 Type 1 Class B Resin Base | CCC-2011-01-007 |
| Hunt Process Corp. Southern PO Box 688 Ridgeland, Mississippi 39158 Sales: (601) 856-8811 Fax: (601) 856-0723 Mr. Rick Largent | Hunt Process White Pigmented Type 2 Class A WS Wax Base | CCC-2005-06 |
| Kaufman Products Inc. 3811 Curtis Avenue Baltimore, Maryland Sales: (800) 637-6372 Fax: (601) 856-0723 Mr. Alex Kaufman | Thinfilm 450 Type 2 class B Resin Base | CCC-2009-06 |
| | Thinfilm 445 Type 2 Class A Wax Base | CCC-2005-03 |
| | Thinfilm 420 Type 1 Class B Resin Base | CCC-2009-05 |

Contact Person for SCDOT:

Caleb Gunter
Structural Materials Engineer
SCDOT Office of Materials and Research
PO Box 191
Columbia, SC 29201
Telephone: (803) 737-6694
Email: guntercb@scdot.org

**SOUTH CAROLINA
 DEPARTMENT OF TRANSPORTATION**

Qualified Corrosion Inhibitors for Concrete

| <u>Producer</u> | <u>Trade Name</u> | <u>Recommended Dosage</u> |
|--|---|----------------------------|
| W.R. Grace and Company 62 Whittermore Avenue Cambridge, MA 02140 Tel: 617-876-1400 Denise Preston denise.i.preston@grace.com | Calcium Nitrite DCI | 2 gal/ c.y. |
| BASF Corporation 23700 Chagrin Blvd. Cleveland, OH 44122 1-800-451-5833 Richard Morrow dmorrow@mbt.com | Reocrete 222 *Reocrete CNI *NTPEP #: CADD-2011-01-041 | 1 gal/c.y. 1-6 gal/c.y. |
| The Euclid Chemical Company 19218 Redwood Road Cleveland, OH 44110 Tel: 216-692-8360 1-800-321-7628 Fax: 216-531-9399 Bob Bucheral bob@euclidchemical.com | CIA | 1 gal/c.y. |
| Cortec Corporation 4119 White Bear Pkwy St. Paul, MN 55110 Tel: 651-429-1100 Fax: 651-429-1122 1-800-4-cortec Jessi Jackson Meyer jessij@cortecvci.com | MCI 2000 MCI 2005 | 1 pint/c.y. 1 pint/c.y. |
| Sika Corporation 201 Polito Avenue Lyndhurst, NJ 07071 Tel: 201-508-6656 Cell: 717-821-3721 Paul (pj) Jordan jordan.paul@sika-corp.com | Sika CNI | 3 gal/ c.y. |
| Goulson Technologies, Inc. 700 N. Johnson St. Monroe, NC 28110 Cell: 706-614-3052 John Howell jhowell@goulston.com | Chupol CI | 2-6 gal/ c.y. |

SCDOT CONTACT PERSON:

Caleb Gunter

Structural Materials Engineer

SCDOT Office of Materials and Research

PO Box 191

Columbia, SC 29201

Telephone: (803) 737-6694

Email: guntercb@scdot.org

**South Carolina Department of Transportation
Temporary Concrete Barrier Producers**

| <u>PRODUCER</u> | <u>STANDARD DRAWINGS</u> | <u>CODE</u> | <u>APPROVAL DATE</u> | <u>EXPIRATION DATE</u> |
|---|--|-------------|--------------------------|----------------------------|
| Utility Precast, Inc. 939 West Craighead Road Charlotte, NC 28206 1-800-280-5085 Contact: Mr. Chip Harris | 605-210-01 605-210-02 605-210-03 605-210-04 | UP | 05/11 | 05/13 |
| Curtin P. O. Box 38220 Charlotte, NC 28278 1-704-588-7899 Contact: Mr. Clyde Hopkins 1-704-588-7055 | 605-210-01 605-210-02 605-210-03 605-210-04 | CT | 05/11 | 05/13 |
| TIC P.O. Box 9207 Savannah, GA 31412 1-912-235-4872 ext 1765 Contact: David Maher | 605-210-01 | TIC | 08/13 | 08/15 |
| Seminole Precast Manufacturing, Inc. P. O. Box 3177 Macon, GA 31205 1-478-781-2090 Contact: Daniel Moody | 605-205-01 605-205-02 605-205-03 | SPI | 08/11 | 08/13 |

Contact: All questions and correspondence regarding this qualified product list should be directed to:

Caleb Gunter
Structural Materials Engineer
SCDOT Office of Materials and Research
PO Box 191
Columbia, SC 29201
Telephone: (803) 737-6694
Email: guntercb@scdot.org

SOUTH CAROLINA DEPARTMENT OF TRANSPORTATION

Qualified Suppliers of Reinforcing Steel

These Producers are qualified in accordance with SCDOT Qualified Product Policy 60. Trade names are registered trademarks of the appropriate company.

| SCDOT PRODUCER CODE | Producer | Contact /Telephone |
|------------------------------|---|---|
| SteelRebarCo005 (CMCCSC) | CMC Steel South Carolina 310 New State Road Cayce, SC 29033 | Clyde Ditolla (803) 936-3867 Clyde.ditolla@cmc.com |
| SteelRebarCo029 (CMCDOK) | CMC Steel Oklahoma 584 Old Highway 70 Durant, OK 74702 | Robbie Booth (480) 396-7127 Robert.booth@cmc.com |
| SteelRebarCo002 (CMCJFL) | CMC Steel Florida 16770 Rebar Road Jacksonville, FL 32234 | Alex Renosto (904) 266-1468 alexander.renosto@cmc.com |
| SteelRebarCo003 (CMCKTN) | CMC Steel Tennessee 1919 Tennessee Avenue Knoxville, TN 37921 | Jim Hall (865) 202-5972 James.Hall@cmc.com |
| SteelRebarCo033 (CMCMAZ) | CMC Steel Mesa 11444 East Germann Road Mesa, AZ 85242 | Jacob Selzer (480) 396-7101 Jacob.Selzer@cmc.com |
| SteelRebarCo017 (CMCSNJ) | CMC Steel New Jersey 1 North Crossman Road Sayreville, NJ 08872 | Joe Homic (800) 721-8047 Joseph.Homic@cmc.com |
| SteelRebarCo022 (CMCSTX) | CMC Steel Texas 1 Steel Mill Drive Seguin, Texas 78155 | Jason Dinscore (830) 372-8746 Jason.dinscore@cmc.com |
| SteelRebarCo023 (CMCRCCA) | CMC Steel California 12459-B Arrow Road Rancho Cucamonga, CA 91739 | Michael Mayer (909) 646-7886 Michael.Mayer@cmc.com |
| SteelRebarCo021 (EVRAZCO) | Evraz Rocky Mountain Steel 2100 South Freeway Pueblo, CO 81004 | Billy Byrd (719) 561-6426 Billy.byrd@evrazna.com |
| SteelRebarCo001 (GACNC) | Gerdau Ameristeel (Charlotte Mill) 6601 Lakeview Road Charlotte, NC 28269 | Rachel Warren (704) 596-0361 Ext. 3039 Rachel.Webster@gerdau.com |
| SteelRebarCo019 (LSPIL) | Liberty Steel 7000 S.W. Adams Street Peoria, IL 61641-0002 | Tyler Higgins (309) 697-7173 tyler.higgins@libertysteel.us |
| SteelRebarCo034 (NSAFL) | Nucor Steel (Florida) 22 Nucor Drive Avon Park, FL 33843 | Tad Nowlin (863) 546-5796 Tad.nowlin@nucor.com |
| SteelRebarCo024 (NSANY) | Nucor Steel (Auburn) 25 Quarry Road Auburn, NY 13021 | Rachel Palmer (315) 258-4207 Rachel.Palmer@nucor.com |
| SteelRebarCo013 (NSBAL) | Nucor Steel (Alabama) 2301 F.L. Shuttlesworth Drive Birmingham, AL 35234 | George Miljus (205) 250-7417 george.miljus@nucor.com |
| SteelRebarCo014 (NSBIL) | Nucor Steel (Illinois) 1 Nucor Way Bourbonnais, IL 60914 | Jason Rivera (815) 929-3524 Jason.rivera@nucor.com |











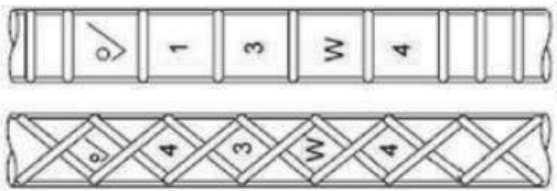
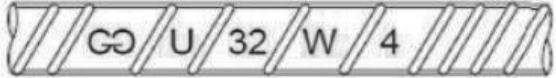
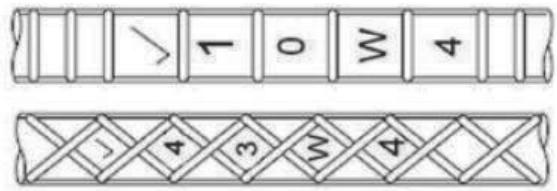

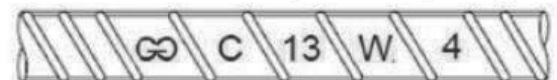
QUALIFIED PRODUCT LIST 60
For Class Purposes Only **January 10, 2022**
Page 2 of 6

| | | |
|-----------------------------|--|---|
| SteelRebarCo016 (NSKAZ) | Nucor Steel (Arizona) 3000 West Old Highway 66 Kingman, AZ 86413 | Vijay M. Choksi (928) 718-7035 Ext. 217 Vijay.Choksi@nucor.com |
| SteelRebarCo025 (NSMOH) | Nucor Steel (Ohio) 912 Cheney Avenue Marion, OH 43302 | Justin Spitzer (704) 383-9651 Justin.spitzer@nucor.com |
| SteelRebarCo027 (NSPUT) | Nucor Steel (Utah) 7285 W 2100 N West Cemetery Road Plymouth, UT 84330 | Brenda Porath (435) 458-9208 brenda.porath@nucor.com |
| SteelRebarCo031 (NSSMO) | Nucor Steel (Sedalia) 500 Rebar Road Sedalia, MO 65301 | Karan Bajwa (660) 951-1732 Karan.bajwa@nucor.com |
| SteelRebarCo008 (NSSWA) | Nucor Steel (Washington) 2424 SW Andover Street Seattle, Washington 98106 | Erik Nissen (206) 724-4727 Erik.Nissen@Nucor.com |
| SteelRebarCo012 (NSWCT) | Nucor Steel (Connecticut) 35 Toelles Road. Wallingford, CT 06492 | John Brasell (203) 949-6848 John.brasell@nucor.com |
| SteelRebarCo010 (OSVTX) | Optimus Steel 100 Old Highway 90 West Vidor, TX 77704 | Leonardo Radicchi (409) 769-1086 leonardo.radicchi @optimus-steelusa.com |
| SteelRebarCo032 (SDICCN) | Steel Dynamics, Inc. 2601 South County Road 700 East Columbia City, IN 46725 | Kimberly Lickey (260) 625-8460 Kimberly.Lickey@steeldynamics.com |
| SteelRebarCo028 (SDIPIN) | Steel Dynamics, Inc. 8000 N County Road 225 E Pittsboro, IN 46167 | Brandon Dugan (317) 892-7166 Brandon.Dugan2@steeldynamics.com |
| SteelRebarCo030 (SDIRVA) | Steel Dynamics, Inc. 102 Westside Boulevard NW Roanoke, VA 24017 | Lewis Leftwich (540) 510-3185 Lewis.leftwich@steeldynamics.com |

SCDOT contact person for this Qualified Product List:

Caleb Gunter, PE
Structural Materials Engineer
SCDOT Office of Materials and Research
1406 Shop Road
Columbia, SC 29201
Telephone: (803) 737-6694
E-mail: guntercb@scdot.org

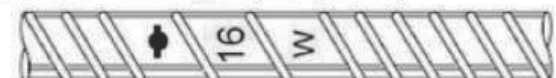
Current Acceptable Rebar Mill Markings

| | |
|--|--|
| <p>CMC Steel - South Carolina [CMCCSC]</p>  | <p>Gerdau Ameristeel - St. Paul, Minnesota [GASPMN]</p>  |
| <p>CMC Steel - Texas [CMCSTX]</p>  | <p>Gerdau Ameristeel - Midlothian, Texas [GAMTX]</p>  |
| <p>Gerdau Ameristeel - Charlotte, N.Carolina [GACNC]</p>  | <p>Nucor Steel - Darlington, South Carolina [NSDSC]</p>  |
| <p>Gerdau Ameristeel - Knoxville Steel [GAKTN]</p>  | <p>Nucor Steel - Mississippi [NSFMS]</p>  |
| <p>Gerdau Ameristeel - Jacksonville Steel [GABFL]</p>  | <p>Nucor Steel - Seattle Washington [NSSWA]</p>  |
| <p>Gerdau Ameristeel - Beaumont Mill [GABTX]</p>  | <p>Nucor Steel - Connecticut [NSWCT]</p>  |
| <p>Gerdau Ameristeel - Jackson Tennessee [GAJTN]</p>  | <p>Nucor Steel - Birmingham , Inc. [NSBAL]</p>  |
| <p>Nucor Steel - Kingman, AZ [NSKAZ]</p>  | <p>Nucor Steel - Kankakee, Inc. [NSBIL]</p>  |

Notes:



SOUTH CAROLINA DEPARTMENT OF TRANSPORTATION

Authorized Producers of Reinforced Concrete Pipe (RCP)

The following is a list of Reinforced Concrete Pipe (RCP) producers who have satisfied the requirements established by the SCDOT as defined by Qualified Product Policy 69.

| Producers | Plant Certification Expiration Period | Reinforced Concrete Pipe Using Flexible Sealants (FS) | | | Reinforced Concrete Pipe Using Rubber Gaskets (RG) | | | Notes |
|--|--|---|--------------|---|--|--------------------|---|---------------------|
| | | Pipe Size | Sealant Size | Flexible Sealant Manufacturer | Pipe Size | Rubber Gasket Size | Rubber Gasket Manufacturer | |
| **CP & P, LLC 2750 Azalea Drive Charleston, SC 29405 Tel: 1-843-744-5376 Fax: 1-843-566-7956 Michael Troan | ACPA Q-Cast Jan 1, 2016 Through Jan 1, 2018 | 12"-36" | 3/4" | Concrete Sealants Materials, New Carlisle, Ohio | 12" – 36" | 158-4G | Press-Seal Gasket Corporation Fort Wayne IN | Profile Style Joint |
| | | 42"-72" | 1 1/4" | | 42" – 72" | 210-4G | | |
| Concrete Designs, LLC P.O. Box 15164 Surfside Beach, SC 29587 Tel: 1-843-650-0099 Jimmy Kid | *NPCA Dec 31, 2017 | 15" – 36" | 1" | Concrete Sealants Materials' New Carlisle, Ohio | | | | |
| | | 48" – 60" | 1 1/4" | | | | | |

| | | | | | | | |
|--|--|--|--------------------------------|---|-------------------------------------|---|---|
| Diamond Concrete, LLC P.O. Box 1370 Rincon, GA 31326 Tel: 1-912-728-9485 Alan Zipperer | *NPCA Dec 31, 2016 | 15" – 36" 42" – 60" | 1" 1 1/4" | Concrete Sealants Materials' New Carlisle, Ohio | 15" – 60" | 155– 4G | Press-Seal Gasket Corporation Fort Wayne IN Universal Polymer Ravenna, OH Hamilton Kent LLC Toronto, Ontario Winchester, TN |
| Foley Products Company 1291 Hardigree Road Winder, GA 30680 Tel: 1-770-868-0118 Fax: 1-770-307-5918 Mbl: 1-404-787-1367 Dennis Morrissey | ACPA Q-Cast Jan 1, 2015 Through Jan 1, 2017 | | | | 15" – 36" 42" – 96" | 155-4G 260-4F CR147 CR066 CR023 BN3RCP BN7RCP | Press-Seal Gasket Universal Polymer C - Tech C – Tech |
| Foltz Concrete Pipe 11875 North NC Hwy 150 Winston Salem, NC 27127 Tel: 1-336-764-0341 Doug Shell | *NPCA Dec 31, 2016 | 15" – 18" 24" – 30" 36" – 42" 48" – 72" | 3/4" 1" 1 1/4" 1 1/2" | Concrete Sealants Materials' New Carlisle, Ohio | 15" – 36" 42" – 72" | 158-4G 210-4G | Press-Seal Gasket Corporation Fort Wayne IN |
| Gossett Concrete Pipe P.O. Box 3683 Greenville, SC 29608 Tel: 1-864-242-3593 Fax: 1-864-244-4720 Plant: 1-864-244-0370 | ACPA Q-Cast Oct 1, 2015 Through Oct 1, 2017 | 12"-24" (1) 30"-36" (1) 42"-48" (1) | 3/4" 1" 1 1/4" | Concrete Sealants Materials, New Carlisle, Ohio Multiseal, Inc | 15" – 36" 42" – 72" 15" – 36" | V-0168 .326AS V-0166 .446AS 3 SOCL | Vertex Inc. Mogadore, OH Hamilton |
| | | | | | | | Profile Style Joint |
| | | | | | | | Profile Style |
| | | | | | | | (1) Tongue & Groove Style Joint (2). Profile Style Joint |

Notes:

- a. RG: AASHTO M 315 Standard Specification for Joints for Concrete Pipe and Manholes, Using Rubber Gaskets (13-psi. in straight alignment and 10-psi. in deflected alignment in plant hydrostatic test).
- b. FS: AASHTO M 198 Standard Specification for Joints for Concrete Pipe, Manholes, and Precast Box Section Using Preformed Flexible Sealants (10-psi. in plant hydrostatic test).
- c. For the following counties: Berkeley, Beaufort, Charleston, Colleton, Dorchester, Georgetown, Horry, and Jasper, provide pipe joints meeting AASHTO M 315 (13 psi), for all other counties, either M 190 (10 psi) or M 315 may be used unless noted otherwise in the plans or special provision.

*NPCA performs their audits on the specific date listed above – ACPA performs their audits through the expiration period without any announcement.

SCDOT Contact Person:
Caleb Gunter
Structural Materials Engineer
SCDOT Office of Materials and Research
PO Box 191
Columbia, SC29201
Telephone: (803) 737-6694
Email: guntercb@scdot.org

SOUTH CAROLINA DEPARTMENT OF TRANSPORTATION

Qualified Products List of Mechanical Couplers for Reinforcing Steel

Mechanical Couplers for Reinforcing Steel on this qualified product list comply with Subsection 703 of the Standard Specifications. This table was prepared to provide a reference source for rebar splicing systems currently authorized for use by SCDOT.

| Splice Company | Coupler Model | Authorized Service Splice (Bar Sizes) | Authorized Ultimate Splice (Bar Sizes) |
|--|------------------------------------|---------------------------------------|--|
| Headed Reinforcement Corp. (HRC) 11200 Condor Ave Fountain Valley, CA 92708 Jeremy Maldonado 714-852-1333 | HRC 410/420 Standard Coupler | #8 through #18 | #8 through #18 |
| | Xtender 500/510 Standard Coupler | #4 through #14 | #4 through #14 |
| Erico Products, Inc. 34600 Solon Road Cleveland, OH 44139 Craig Guy 843-340-5420 | Lenton A-2 Standard Coupler | #4 through #18 | #4 through #18 |
| | Lenton P Position Coupler | #4 through #18 | #4 through #18 |
| | Lenton D6 Terminator Coupler | #4 through #18 | #4 through #18 |
| Dayton Superior Corporation 1125 Byers Road Miamisburg, OH. 45342 Timothy Fondelier 412-812-4848 Ben Rivera 978-994-0477 | Barlock SCA Series | #4 through #18 | #4 through #18 |
| | Barlock L Series | #4 through #18 | #4 through #18 |
| Barsplice Products, Inc. 4900 Webster St. Dayton, OH 45414 Jon Bonner 937-275-8700 EX-243 | Bargrip XL | | #5 through #18 |
| | Barsplicer XP | | #4 through #11 |
| | Taper Threaded Grip Twist | | #3 through #18 |
| | Taper Threaded Grip Twist Position | #5 through #18 | |
| | Zap Screwlok Type 2 | #4 through #18 | |

| | | | |
|---|----------------------------|----------------|--|
| Barsplice Products, Inc. 4900 Webster St. Dayton, OH 45414 Jon Bonner 937-275-8700 EX-243 | Zap Screwlok Epoxy | #4 through #18 | |
| | Zap Screwlok SL | #4 through #18 | |
| | Double Barrel Zap Screwlok | #4 through #18 | |

Contact Engineer for SCDOT:
 Caleb Gunter
 Structural Materials Engineer
 SCDOT Office of Materials and Research
 PO Box 191
 Columbia, SC 29201
 Telephone: (803) 737-6694
 Email: guntercb@scdot.org

SOUTH CAROLINA DEPARTMENT OF TRANSPORTATION

Qualified Products List for Preformed Rubber Joint Filler Materials

The following products are preformed rubber joint filler materials that have been qualified by the Office of Materials and Research and comply with SCDOT specifications.

Products

Manufacturer

Sponge Rubber Expansion Joint
(Black Material)

Right Pointe/**J &K
P.O. Box 467
234 Harvestore Drive
DeKalb, IL 60115-8604
(815) 754-5700

Sponge Rubber Expansion Joint
(Black Material)

Bob Warner, Inc.
477 Pine Glen Rd.
Karthaus, PA 16845
814-430-2161

Sponge Rubber Expansion Joint
(Gray Material)

W.R. Meadows
100 Riverside Drive
Cartersville, GA 30120
(770) 586-6440

**J &K Foam Fabricating, Inc.
66 Robinson Street
Pottstown, PA 19464
877-823-1059

Contact Person for the SCDOT:

Caleb Gunter
Structural Materials Engineer
SCDOT Office of Materials and Research
PO Box 191
Columbia, SC29201
Telephone: (803) 737-6694
Email: guntercb@scdot.org



SOUTH CAROLINA DEPARTMENT OF TRANSPORTATION

AUTHORIZED SUPPLIERS OF TYPE IL PORTLAND-LIMESTONE CEMENT

The following is a list of Type IL Portland-Limestone Cement Suppliers who have satisfied the requirements established by the SCDOT as defined by Qualified Product Policy 86. Cement must be from a qualified source listed on SCDOT qualified product list 6, "Authorized Portland Cement and Non-Steel Slag Manufacturers." All trade names are registered trademarks of the appropriate companies.

| Manufacturer | Trade Name | Type | Mill and Transfer Silo Terminals |
|--|------------|--------|-------------------------------------|
| Holcim (US) Inc. 9624 Bailey Road Suite 275 Charlotte, NC 29201 Tel: (800) 845-1120 Fax: (704) 895-5961 Eddie Deaver edward.deaver@holcim.com | | IL(10) | Holly Hill Plant, Holly Hill, SC |

SCDOT Contact Person:
Caleb Gunter
Structural Materials Engineer
SCDOT Office of Materials and Research
PO Box 191
Columbia, SC 29201
Telephone: (803) 737-6694
Email: guntercb@scdot.org

CHAPTER 4

SCDOT 2007 Standard Specifications for Highway Construction

Section 701: Portland Cement and Portland Cement Concrete

- Chapter 4 Presentation
- Concrete Materials

SCDOT PCC SPECIFICATIONS

(Chapter 4)



SOURCES OF SPECIFICATIONS

Specifications can come from:

1. AASHTO
2. Instructions from the RCE
3. Project Proposal
4. Project Plan & SCDOT Standard Drawings
5. SCDOT Standard Specifications
6. SCDOT Construction Manual
7. SCDOT Material Approval



SCDOT ORGANIZATION

Resident Construction Engineer

- Ultimate authority on the Project
- Maintains a weekly diary compiled from inspectors diaries
- Provides monthly estimates and updates of work completed



SCDOT ORGANIZATION

Portland Cement Concrete Inspector

*****Could be You*****



- Observes contractor and performs testing
- Tracks quantities
- Maintains a diary of quantities and observations



WHAT DO THE SPECS PERTAIN TO?

- Materials
- Building Processes
- Construction Supervision

SCDOT Specs begin with the building materials.



STANDARD SPECIFICATIONS

SCDOT 2007 Standard Specs for Highway Construction [Black Book]

701 Portland Cement and PCC

702 Concrete Structures

703 Reinforcing Steel

Written with the Contractor's point of view as the primary concern.



STANDARD SPECIFICATIONS SCDOT Abbreviations

| | |
|------------|--------------------------------|
| BCE | Bridge Construction Engineer |
| BDE | Bridge Design Engineer |
| OMR | Office of Materials & Research |
| RCE | Resident Construction Engineer |
| SME | Structural Materials Engineer |

Taken from the list of abbreviations – 2007 Standard Specifications



STANDARD SPECIFICATIONS 701 Portland Cement and PCC

701.2 Materials

- Portland Cement (701.2.1)
- Fly Ash (701.2.2)
- Silica Fume (701.2.4)
- Air Entrainment (701.2.5)
- Admixture Policy (701.2.6-8)
- Aggregates (701.2.9-10)
- Water (701.2.11)



STANDARD SPECIFICATIONS

701 Portland Cement and PCC

701.2.12 Concrete Mix Design

Covers Mix Design Principles

Contains the Structural Concrete Table

- Probably the most important table in the book for PCC Structures [Chapter 4, Pages 22-24]
- Based on Class and Course Aggregate Type
- Min. cement content, aggregate ratio, max water: cement ratio as well as 28 day design strength

Non-Conforming Concrete



STANDARD SPECIFICATIONS

701 Portland Cement and PCC

701.3 Equipment (Production)

Weighing Equipment (701.3.2)

Central Mix Plants (701.3.3)

Truck Mixers (701.3.4)

701.4 Construction

Material Storage (701.4.1-3)

Batching and Mixing (701.4.4)

Consistency (701.4.5)



**WHERE SHOULD CONCRETE MIX
DESIGN BE SUBMITTED?**

WHO APPROVES THE MIX DESIGN?



ANSWER:



**What Happens When Concrete
Cylinders Don't Meet Strength
Requirements**



| Cylinder Test Results: | Price Reduction per cubic yard (Percent) X (Contract Unit Price) | |
|------------------------|--|------------------------------|
| | With Contract Unit Price | Without Contract Unit Price* |
| 98.0 - 100.0 | 0% | 0% |
| 95.0 - 97.9 | 5% | 25% |
| 90.0 - 94.9 | 10% | 50% |

* If there is no contract unit price for concrete, use (percent reduction) x (supplier's invoice unit cost).

The BCE may approve use of concrete test method **SC-T-49** to determine the accepted strength if the concrete test cylinders have been considered non-conforming.

The total amount of the price reduction will not be less than \$500.00.

- 2 If any cylinder test result is below 90%, take cores in the presence of the BCE or RCE from the concrete in the structure that is represented by the non-conforming test cylinders in order to evaluate the strength of the concrete in place. Ensure that test cores are taken, conditioned, and tested in accordance with the requirements of **Subsection 701.2.12.4.2.2**.

701.2.12.4.2 Procedure for Testing Non-conforming Concrete

701.2.12.4.2.1 Limits of Questionable Concrete

- 1 The limit of questionable concrete is determined by using concrete test method **SC-T-49**. Acceptance is solely based on the compressive strength of the cores removed from the in-place concrete, unless authorized otherwise by the BCE.

Cores or SC-T-49 (ASTM C805)

701.2.12.4.2.4 Acceptance of Concrete

- 1 Acceptance of the concrete from which the cores are taken is based on the core test results. If access to the concrete is not practical for obtaining cores or the taking of cores would result in irreversible damage to the structure, the BCE may approve concrete test method **SC-T-49** to determine the strength of the concrete.
- 2 If the **SC-T-49** test results or the core test results are below 90%, but are equal to or greater than 85% of the design strength, obtain a design analysis based on the reduced strength from the Designer-of-Record. Based on the design analysis, the BCE will determine if the concrete can remain in place. If the concrete test results are less than 85% of the design strength, remove the concrete unless authorized otherwise in writing by the BCE.



3 If non-conforming concrete is allowed to remain in-place, a price reduction on the quantity of concrete in question is determined by the following table.

| Price Reduction for Non-conforming Concrete Left In-Place | | |
|---|---|-----------------------------------|
| Core Test Results: * | Price Reduction per cubic yard (Percent) X (Contract Unit Price) | |
| Percent of Minimum Strength | With Contract Unit Price | Without Contract Unit Price ** |
| 98.0 - 100.0 | 0% | 0% |
| 95.0 - 97.9 | 5% | 25% |
| 90.0 - 94.9 | 10% | 50% |
| 85.0 - 89.9 | 15% *** | 80% |

* Or SC-T-49 if approved by the BCE.

** If there is no contract unit price for concrete, use (percentage) x (supplier's invoice unit cost).

*** Use 15% of contract unit price or 80% of supplier's invoice unit cost, whichever is greater.

The total amount of the Price Reduction will not be less than \$500.00.

Hot & Cold Weather Concrete



***See Chapter 5 for New Supplemental Specifications regarding new Hot & Cold Weather Plans for jobs Let 7/1/2018 and after.

SLUMP ADJUSTMENTS

701.4.6 ADDING WATER

In the event additional water is required to obtain the specified slump at the work site, the RCE may approve adding water from an acceptable water supply at the rate of 1 gallon per cubic yard per inch of desired slump, but not to exceed the maximum water to cementitious material ratio shown in the table in **Subsection 701.2.12.2**. When additional water is added, make certain that the truck mixer drum turns a minimum of 25 revolutions at mixing speed before discharge of the concrete.



SLUMP ADJUSTMENTS

701.4.7 CHEMICAL ADMIXTURES



Type F or Type G admixtures may be added to concrete to increase workability and/or to reduce the water to cementitious material ratio. Type F is a HRWR, and Type G is a High Range Water Reducer-Retarder. If these admixtures are used, add them at the work site just before discharge, and mix concrete for a minimum of 30 seconds per cubic yard of concrete in the mixer after each addition of an admixture. Measure the slump of the concrete before the addition of the high-range admixture, and make certain not to exceed the maximum slump limits indicated above. Discontinue or avoid the use of admixtures when there is any indication of excessive flow, bleeding, or segregation. The admixture may be added a second or third time to re-establish mixture flow if the maximum time for placing the concrete after the mix water.



STANDARD SPECIFICATIONS

701 Portland Cement and PCC

701.4 Construction (continued)

Slump (701.4.6)

Use of Water Reducers & Water Reducer-Retarders
(701.4.7-8)

Fly Ash and Water-Granulated Blast Furnace Slag
(701.4.9)



FLY ASH REPLACEMENT

701.4.9 Fly Ash & Water-Granulated Blast-Furnace Slag

The addition of fly ash or water granulated blast-furnace slag is allowed in the concrete mix if the following requirements are met when using these materials:

- A. Fly ash or water-granulated blast-furnace slag may replace allowable percentages of Type I, Type II, or Type III Portland cement. Do not use fly ash or slag replacement for mixes using Type I (SM) or any other blended cement.
- B. Remove forms in accordance with **Subsection 702.4.5**.
- C. When fly ash is used to replace the Portland cement, replace at a ratio of not less than 1.2:1 by weight, and do not replace more than 20% of the cement originally called for in the mixture.



RELATIONSHIP OF CONSTRUCTION MANUAL AND STANDARD SPECIFICATIONS

Labeled concurrently with Standard Specifications of
Chapters 4 & 10 (2007 Black Book)

| TOPIC | CONSTRUCTION MANUAL CHAPTER 9 | STANDARD SPECIFICATIONS CHAPTER 4 & 10 |
|------------|----------------------------------|---|
| Aggregates | <u>701.2.4.3</u> | <u>701.2.9</u> & <u>701.2.10</u> |



SCDOT PCC SUPPLEMENTAL SPECIFICATIONS AND DEPARTMENT MEMOS (Chapter 5)



DIVISION 700

STRUCTURES

SECTION 701

PORTLAND CEMENT AND PORTLAND CEMENT CONCRETE

701.1 Description

- 1 This section contains specifications for the materials, construction, measurement, and payment for furnishing, storing, and handling of the materials; and the proportioning, mixing, and delivery of Portland cement concrete for structures.

701.1.1 Classes of Concrete

- 1 Classes of concrete typically used by the Department are listed in the Structural Concrete Table in **Subsection 701.2.12.2**. The numerical portion of the Class is the minimum 28-day mix design strength based on ASTM C 39.

701.2 Materials

701.2.1 Portland Cement

701.2.1.1 General

- 1 Use Portland cement conforming to the requirements of the following specifications for the type required or permitted and obtained from a source listed on the most recent edition of *SCDOT Qualified Product List 6* with the additional requirements stated hereafter.
- 2 Use Portland cement concrete for structures composed of Portland cement, fine aggregate, coarse aggregate, water, air-entraining admixture, and other permitted or required admixtures. Fly ash, water granulated blast-furnace slag, and silica fume may be added or used as a replacement for a portion of the Portland cement and is considered as cement in the water-cementitious material ratio unless otherwise designated. Ensure that the materials conform to the requirements hereinafter specified. Prepare and deliver the mixture in accordance with these specifications.
- 3 Comply with compressive strength requirements and meet the requirements for low-alkali cement (0.6 maximum).
- 4 Except for cement in RC pipe and prestressed or precast products, use cement complying with the maximum limits of fineness of grind in AASHTO M 85 controlled as follows:
 - A. Ensure that the cement in the mill test reports furnished by the manufacturer complies with the maximum fineness (air permeability test) values stated in AASHTO M 85.

B. Take job control samples at random at the project site and submit them to the OMR for testing. Make certain that the maximum fineness limit (air permeability test) is in conformance with the requirements of AASHTO M 85 with allowance for variations in sampling, presence of moisture in the sample, age of the cement production, and multi-laboratory coefficient of variation.

5 Type I (SM) slag-modified Portland cement may be used instead of Type I and Type II cement. If used, furnish Type I (SM) cement conforming to the requirements of AASHTO M 240 and obtain from the sources listed on the most recent edition of *SCDOT Qualified Product List 18*. Provide an intimate and uniform blend of Portland cement and granulated blast-furnace slag. In any case, make certain that the slag constituent is less than 25% of the total weight of the slag-modified Portland cement.

6 Furnish certified mill test reports to the RCE as outlined in the most recent edition of *SCDOT Qualified Product Policy 6*.

7 Do not store incompatible brands of cement or different types of cement in the same cement storage bin or silo and do not use them together in any continuous pour.

8 Have the weighing and handling procedures of bulk cement approved by the OMR before its use. Protect cement shipments at all times. Inspect, sample, and test questionable cement before its use. Do not use cement that is lumpy, caked, or from open or otherwise damaged bags.

9 Measure cement by weight or by the bag as packed by the manufacturer. Unless another weight is indicated on the bag, use 94 pounds as the weight of one bag of cement.

10 Whenever it is determined by subsequent laboratory testing of mill or job control samples that a cement shipment does not comply with these specifications, discontinue use of the cement from that cement mill until testing reveals that the problem has been corrected. The Contractor is responsible for replacing or otherwise making satisfactory the concrete in which any defective cement is used.

701.2.2 Fly Ash

1 Use fly ash (Type C or Type F) conforming to the requirements of AASHTO M 295, except for the supplementary optional physical requirements. Use fly ash from sources listed on the most recent edition of *SCDOT Qualified Product List 3*.

701.2.3 Water Granulated Blast-Furnace Slag

1 If slag is used, use water granulated blast-furnace slag Class 100 or higher conforming to the requirements of ASTM C 989.

701.2.4 Silica Fume

- 1 Use silica fume meeting the general requirements of ASTM C 1240. Make certain that the raw silica fume meets the chemical requirements of Table 1 and Table 2 and the physical requirements of Table 3 in ASTM C 1240. Furnish the manufacturer's certification stating the results of tests made on samples of silica fume during production and that the applicable requirements of ASTM C 1240 have been met. Provide certification for each lot of each shipment to the RCE and to the OMR.
- 2 Silica fume may be added to the mix in either a dry (densified) form or a wet (slurry) form. The dry form is usually supplied in 50-pound bags. When a dry form is used, adjust the mix design to use whole bags of silica fume, i.e. do not use partial bag(s). Whole bags of silica fume in excess of the normal 50-pound bag and whole bags as small as 40 pounds are permitted only if approved by the RCE. Make certain that the guidelines of OSHA regulations for worker protection are followed.
- 3 When a wet (slurry) form is used, compute the water contained in the slurry and count it as part of the total water in the mix. Ensure that this data is in accordance with the manufacturer's certified quality test report for the lots of silica fume being used in the mix.

701.2.5 Air Entrained Concrete

- 1 Unless otherwise specified, use a design mix for air-entrained concrete based on 4.5% ($\pm 1.5\%$) entrained air, except for prestressed concrete. If the concrete is pumped, then the entrained air will be acceptable at 5.5% ($\pm 1.5\%$) measured at the truck.
- 2 Do not use air entrainment exceeding the maximum limits specified in the paragraph above. Air entrainment for Class 10000 concrete is left to the judgment of the Contractor and approval of the OMR.
- 3 Use air entrained concrete in all bridge columns, bent or pier caps, decks, sidewalks, parapets, barrier walls, and other structural elements on the bridge deck regardless of the class of concrete used.
- 4 When air-entrainment is used, vary the proportions of water, fine aggregate, and coarse aggregate from those specified herein to maintain the specified strength of the concrete. Use approved admixture specified in **Subsection 701.2.5.1** to obtain the required air entrainment.

701.2.5.1 Air-Entraining Admixtures

- 1 When air entrainment is required, use air-entraining admixtures complying with AASHTO M 154. Submit an affidavit to the RCE and the OMR to show that the admixture conforms to the requirements of AASHTO M 154. Use admixtures from sources appearing on the most recent edition of *SCDOT Qualified Product List 5*.

701.2.6 Accelerating, Retarding, and Water-Reducing Admixtures

- 1 If the use of a chemical admixture to facilitate concrete placement in adverse conditions is desired, the use of an admixture complying with AASHTO M 194 must be approved by the RCE before its use. The RCE may direct the use of an admixture due to adverse placement conditions.
- 2 When a retarding admixture is desired and approved, use a Type G high range water reducing-retarding admixture or a Type D water reducer-retarder combined with a Type F high range water reducer as provided in **Subsections 701.4.7 and 701.4.8**. Do not use a Type B retarding admixture. Furnish the RCE with an affidavit showing that the admixtures conform to the requirements of AASHTO M 194. Use admixtures from sources appearing on the most recent edition of *SCDOT Qualified Product List 5*.

701.2.7 Corrosion Inhibitor

- 1 When a corrosion inhibitor is required in a concrete mix, add the corrosion inhibitor to the concrete while batching. Use the corrosion inhibitors that appear on the most recent edition of *SCDOT Qualified Product List 53*. Adhere to the manufacturer's written recommendations regarding the use of the admixture including storage, transportation, and method of mixing. Add the corrosion inhibitor to the mix by a dispenser meeting the requirements of **Subsection 701.4.3.4**.
- 2 Furnish the RCE a copy of the manufacturer's certified test report showing the composition of the corrosion inhibitor and the percent of solids.

701.2.8 Calcium Chloride

- 1 If calcium chloride is approved by the RCE for use in non-reinforced concrete during cold weather work, do not exceed a rate of 2% by weight of cementitious material. Use calcium chloride complying with the requirements of AASHTO M 144 for Type S or Type L. In any case, do not use calcium chloride in reinforced concrete structures.

701.2.9 Fine Aggregate for Portland Cement Concrete

701.2.9.1 General

- 1 Submit the fine aggregate in the concrete mix designs for approval by the OMR. Use natural sand, manufactured sand, or a combination of natural and manufactured sand meeting the requirements of **Subsections 701.2.9.2 through 701.2.9.8** below. Do not use marine limestone aggregate in reinforced concrete.

701.2.9.2 Natural Sand

- 1 Use natural sand, FA-10, composed of clean, hard, durable, and uncoated grains that is free of lumps or flaky particles, organic matter, loam, or other deleterious substances.

701.2.9.3 Manufactured Sand

- 1 Use manufactured sand, FA-10M, made from stone meeting all the quality requirements for coarse aggregates.

701.2.9.4 Mixtures of Sand

- 1 When a blend of sands is approved, store and batch the two materials separately unless otherwise approved in writing by the OMR.

701.2.9.5 Organic Impurities

- 1 Make certain that fine aggregate is free of injurious amounts of organic impurities. Do not use fine aggregates, which when subjected to the colorimetric test, AASHTO T 21 for organic impurities, produces a color darker than 3, unless the following criteria is met:
 - Fine aggregate with the color darker than 3 may be used if the relative strength at 7 and 28 days is not less than 95% when tested in accordance with AASHTO T 71 as revised herein.
- 2 Comply with Section 4.2 of AASHTO T 71 revised as follows:
 - Mix one batch of mortar with the aggregate treated in sodium hydroxide and one batch with untreated aggregate on the same day. Mold six 2-inch cubes from each batch. Test three of the cubes from each batch at 7 days and 28 days.

701.2.9.6 Soundness

- 1 Use fine aggregate that has a weighted loss not exceeding 10% by weight when subjected to five alternations of the sodium sulfate soundness test conducted according to AASHTO T 104.

701.2.9.7 Approved Sources

- 1 Use sand from sources that appear on the most recent edition of *SCDOT Qualified Product List 1*.

701.2.9.8 Gradation of Fine Aggregate

- 1 Use fine aggregate for all classes of Portland cement concrete and concrete pavement conforming to the following gradations of FA-10 or FA-10M as indicated in Gradation of Fine Aggregate table in the Appendix of these specifications.

701.2.10 Coarse Aggregate**701.2.10.1 General**

- 1 Use coarse aggregate that is clean, tough, durable crushed gravel or crushed stone. Make certain that it is free from soft, thin, elongated, or laminated pieces and sufficiently washed during production to produce a clean aggregate free from lumps or coatings of clay, disintegrated particles, vegetation, or deleterious substances. Adherent coatings are considered injurious. Do not use coarse aggregate with a Los Angeles Abrasion Loss exceeding 60% as determined by AASHTO T 96. Use coarse aggregate that has a

weighted loss not exceeding 15% when subjected to five alternations of the sodium sulfate soundness test conducted according to AASHTO T 104. Use coarse aggregate for Portland cement concrete conforming to the requirements in **Subsections 701.2.10.2 through 701.2.10.4.**

- 2 Use aggregate from marine limestone quarries only in applications of non-reinforced concrete. Use marine limestone coarse aggregate that has a weighted loss not exceeding 25% when subjected to five alternations of the sodium sulfate soundness test conducted according to AASHTO T 104. When marine limestone aggregate is used, use a sprinkler system to produce a saturated aggregate during concrete batching.

701.2.10.2 Slag

- 1 Use crushed slag or other inert materials having similar characteristics and approved in writing by the OMR, consisting of clean, tough, durable pieces of approved slag or other inert materials, is reasonably uniform in density and quality, and is reasonably free of thin or elongated pieces. Ensure that the slag or other inert material is air-cooled and has a weight of not less than 75 pounds per cubic foot. Do not use crushed slag with a Los Angeles Abrasion Loss exceeding 40% as determined by AASHTO T 96. Do not use slag containing free lime in deleterious quantities as determined by laboratory tests and containing more than 15% by weight of glassy pieces.

701.2.10.3 Approved Sources

- 1 Use coarse aggregate from sources listed on the most recent edition of *SCDOT Qualified Product List 2* and approved for use with Portland cement concrete.

701.2.10.4 Gradation of Coarse Aggregate

- 1 Use Aggregate No. 56, No. 57, or No. 67 as coarse aggregate for Portland cement concrete. Aggregate No. 78 may be used in thin sections and prestressed panels when approved in writing by the OMR. Use only Aggregate No. 67 in prestressed concrete. Do not use blends of aggregate other than Aggregate No. 67, except when approved in writing by the OMR. Use gradation requirements for Aggregate No. 56, No. 57, No. 67, and No. 789 as indicated in the table entitled Gradation of Coarse Aggregates, in the Appendix of these specifications.

701.2.11 Water

701.2.11.1 General

- 1 Make certain that water used in mixing, fogging, or curing of Portland cement concrete is free of salt, oil, acid, alkali, organic matter, sewage, or other substances injurious to the finished product. The RCE in consultation with the SME will be the sole judge in determining whether the water used in mixing, fogging, or curing of Portland cement concrete is reasonably free of salt, oil, acid, alkali, organic matter, sewage, or other substances injurious to the finished product. If at any time, the water is found to be unacceptable by the RCE, discontinue its

use and provide approved water at no additional cost to the Department.

- 2 Conduct tests using the services of a laboratory that has an equipment calibration and verification system, technician training, and an evaluation process in conformance with AASHTO R 18 or, for Chemical Testing, has otherwise been approved by the SCDHEC for the tests being conducted. Supply AASHTO R 18 documentation to the SME for review and acceptance before using a non-SCDHEC approved laboratory. Keep all laboratory test results on file at the concrete plant, and ensure that all reports are readily available to the RCE and the SME. Conduct testing at no additional cost to the Department.

701.2.11.2 Water from a Public Water Supply

- 1 Water from a public water supply may be accepted and approved without being tested.

701.2.11.3 Water from Sources Other than a Public Water Supply

- 1 Do not use water from sources other than a public water supply until tested and approved by the RCE. Do not use wash water in structural concrete or other applications using reinforcing steel.
- 2 For water sources of questionable water quality, except for wash water recycling sources, make a comparison of the water with distilled or other satisfactory water by means of the standard cement test for soundness, time of setting, and 1:3 mortar strength with standard sand conforming to ASTM C 778 using the same cement with each water. Reject the water being tested if there is any indication of unsoundness, change in time of setting of ± 30 minutes, or a reduction of more than 10% in strength from 7 day test results obtained with mixtures containing satisfactory water.
- 3 When required by the SME, determine the acidity or alkalinity of the water in accordance with AASHTO T 26. In the event an approved water source reservoir is relatively shallow, enclose the intake pipe and elevate it to exclude silt, mud, grass, or other foreign matter.
- 4 Water from washout operations or is a blend of concrete wash water and other acceptable water sources is certified by the concrete producer as complying with the requirements of AASHTO M 157, Table 2 (Level 3 – conventionally reinforced concrete in a moist environment, but not exposed to chloride) and either AASHTO M 157, Table 1 (using mortar) or the table below entitled Acceptance Criteria for Questionable Water Supplies (Using Concrete), may be used as mix water. Wash water from mixer washout may be used only with RCE approval. When wash water is permitted, provide satisfactory proof or data that no detrimental effects if potentially reactive aggregates are used. Discontinue use of wash water if undesirable reaction with admixtures or aggregates occurs. Test the wash water or blended water weekly for 4 weeks for compliance with the chemical and physical requirements indicated above. Conduct subsequent tests on the water every month with records of test results provided upon request by the RCE or the OMR.

- 5 In addition, do not allow the specific gravity of the mixing water sampled from the discharge line to exceed 1.03 at any time concrete is being produced for the Department. Check the specific gravity by acceptable means and document the value before commencing the batching operation for use in work for the Department.
- 6 Use the following table to determine acceptance of water.

| Acceptance Criteria for Questionable Water Supplies (Using Concrete) | | |
|--|---|------------------------------|
| Criteria | Limits | Test Method ⁽¹⁾ |
| Compressive Strength, min. percent Control at 7 days | 90 | AASHTO T 22 (ASTM C 39) |
| Time of Set, Deviation from Control | From 1:00 hr. earlier to 1:30 hr later | AASHTO T 197 (ASTM C 403) |
| ⁽¹⁾ Base comparison on fixed proportions and the same volume of test water compared to control mix using public water or distilled water. | | |

701.2.12 Concrete Mix Design

701.2.12.1 General

- 1 Design the concrete mix and determine the proportions of cementitious material, fine aggregate, coarse aggregate, water, air-entraining admixture, and water-reducing or water-reducing set retarding admixture (when used) that produces a workable concrete mix. Meet the criteria for the typical classes of concrete shown in the Structural Concrete Table in **Subsection 701.2.12.2**. Consider the amount of air-entrainment that is incidentally afforded by the use of water-reducing or water-reducing/retarding admixtures. Determine the proportions of ingredients in accordance with requirements for the particular type of work and with consideration of the specific gravities of the materials to provide the desired workability and consistency.
- 2 At its own expense, the Contractor may retain an independent testing laboratory accredited by the AASHTO Accreditation Program to design the mix for the class of concrete specified, or use a mix design previously reviewed and used by the Department.
- 3 Submit all design mixes to the OMR for review using standard forms approved by the SME. After successful review by the OMR, provide a copy of all concrete designs to the RCE.
- 4 For the water-cementitious material ratio, use the ratio of water to cementitious materials by weight.
- 5 Design the concrete mix using Department approved ingredients intended for use in the project and make all trial batches using such materials. Test trial mixes for complete conformance with the Specifications by the approved laboratory engaged by the Contractor.

701.2.12.1

701.2.12.2

- 6 Base mix designs on the air entrainment specifications in **Subsection 701.2.5.**
- 7 Base the total water content of the mix on the weight of cement, fly ash, and silica fume multiplied by the water-cementitious ratio. Do not include the absorbed water in the aggregate as mix water.
- 8 Base mix designs on specific gravities and saturated surface dry moisture contents of aggregate obtained from a source on the most recent edition of *SCDOT Qualified Product List 2.*
- 9 Base the sand to stone ratio on volume. Vary the ratio to obtain good workability.
- 10 No separate payment is made for the cost of the laboratory engaged by the Contractor, the materials furnished and used for trial batches, the preparation and testing of trial batches either by the Contractor or its laboratory, or furnishing the OMR with the mix data, the results of the cylinder tests, and yield to be tested. These costs are considered incidental to the work of the applicable item. Include the cost in the unit prices for the applicable pay items in the Contract.
- 11 After successful review of a design mix by OMR, do not change the mix proportions for concrete of that class unless modifications are necessary and are approved in advance.

701.2.12.2 Structural Concrete Table

- 1 Unless otherwise noted or directed, make certain that the properties of the various classes of concrete incorporated into the work conform to the following Structural Concrete Table. Compressive strength is based on ASTM C 39.

| Structural Concrete Table | | | | | |
|------------------------------------|---|--|-------------------------------------|---|--|
| Aggregate Type | Minimum Cement Content (lbs./CY) | Other Cementitious Material (lbs./CY) | Min. 28 Day Mix Design (psi) | Percent Fine to Coarse Aggregate Ratio | Max. Water to Cementitious Material Ratio |
| Class 2500 (Non Structural) | | | | | |
| Crushed stone | 494 | -- | 2500 | 36:64 | 0.54 |
| Gravel | 494 | -- | 2500 | 35:65 | 0.52 |
| Marine Limestone | 494 | -- | 2500 | 40:60 | 0.56 |

(table continued on the next page)

(table continued from the previous page)

| Structural Concrete Table | | | | | |
|---------------------------------------|---|--|-------------------------------------|---|--|
| Aggregate Type | Minimum Cement Content (lbs./CY) | Other Cementitious Material (lbs./CY) | Min. 28 Day Mix Design (psi) | Percent Fine to Coarse Aggregate Ratio | Max. Water to Cementitious Material Ratio |
| Class 3000 | | | | | |
| Crushed stone | 588 | -- | 3000 | 35:65 | 0.46 |
| Gravel | 588 | -- | 3000 | 34:66 | 0.44 |
| Marine Limestone | 588 | -- | 3000 | 39:61 | 0.47 |
| Class 4000 | | | | | |
| Crushed stone | 611 | -- | 4000 | 35:65 | 0.40 |
| Gravel | 611 | -- | 4000 | 34:66 | 0.40 |
| Class 4000S | | | | | |
| Crushed stone | 682 | -- | 4000 | 38:62 | 0.45 |
| Gravel | 682 | -- | 4000 | 38:62 | 0.45 |
| Class 4000DS (See Notes 2 & 4) | | | | | |
| Crushed stone | 625 | -- | 4000 | 40:60 | 0.44 |
| Gravel | 625 | -- | 4000 | 39:61 | 0.43 |
| Class 4000P (See Note 5) | | | | | |
| Crushed stone | 682 | -- | 4000 | 34:66 | 0.43 |
| Gravel | 682 | -- | 4000 | 33:67 | 0.38 |
| Class 5000 | | | | | |
| Crushed stone | 705 | -- | 5000 | 35:65 | 0.46 |
| Gravel | 705 | -- | 5000 | 34:66 | 0.42 |

(table continued on the next page)

(table continued from the previous page)

| Structural Concrete Table | | | | | |
|---|---|--|-------------------------------------|---|--|
| Aggregate Type | Minimum Cement Content (lbs./CY) | Other Cementitious Material (lbs./CY) | Min. 28 Day Mix Design (psi) | Percent Fine to Coarse Aggregate Ratio | Max. Water to Cementitious Material Ratio |
| Class 6000 | | | | | |
| Crushed stone | 750 | -- | 6000 | 34:66 | 0.44 |
| Gravel | 750 | -- | 6000 | 33:67 | 0.39 |
| Class 6500 (See Notes 1 & 3) | | | | | |
| Crushed stone | 500 | CF35, FA140 | 4000 | 37:63 | 0.37 |
| Gravel | 500 | CF35, FA140 | 4000 | 38.62 | 0.37 |
| Class 7000 | | | | | |
| Crushed stone | 800 | --- | 7000 | 35:65 | 0.37 |
| Gravel | 800 | --- | 7000 | 34:66 | 0.37 |
| Class 8000 | | | | | |
| Crushed Stone | 840 | --- | 8000 | 34:66 | 0.30 |
| Gravel | 840 | --- | 8000 | 34:66 | 0.30 |
| Class 10000 | | | | | |
| Crushed stone, or Gravel | 800 | Silica Fume: 74 & Fly Ash, Type F: 100 | 10000 | 34:66 | 0.25 |

701.2.12.3 Structural Concrete Table Notes**1 Note 1:**

Provide a mix design that yields a 56-day minimum laboratory strength of 6500 psi. Acceptance of in-place concrete is based on a minimum strength of 4000 psi compression strength at a maximum of 28 days or 6500 psi at 56 days.

2 **Note 2:**

Use Type G or Type D admixture.

3 **Note 3:**

Use the following proportions for Class 6500 concrete mix per cubic yard:

| | |
|---|----------------------------------|
| Cement (min.)..... | 500 lbs. |
| Fly Ash..... | 140 lbs. |
| Silica Fume..... | 35 lbs. |
| Corrosion Inhibitor..... | (see Subsection 701.2.7) |
| Entrained Air (Range)..... | 4.5 (± 1.5)% |
| Water-Cementitious Material Ratio (max.)...0.37 | |
| High Range Water Reducer..... | Required |
| Aggregates..... | Variable |

4 If a Type A or Type D admixture is used, demonstrate that the admixture is compatible, does not adversely extend normal setting time, and does not cause excessive bleeding.

5 The slump of the concrete at time of placement in the forms may be increased by the use of a High Range Water Reducer, either Type F or Type G in accordance with the requirements of **Subsection 701.2.6**.

6 If silica fume slurry is used, add it at a point that produces an acceptable mix.

7 Add a High Range Water Reducer at the job site. Limit additional mixing to the minimum specified in accordance with **Subsection 701.4.7**, but it may be increased in order to obtain the necessary air entrainment.

8 Concrete Temperature: Do not allow the temperature of Class 6500 concrete to exceed the maximum permitted in **Subsection 701.4.4.3**.

9 Mix Design Review: Submit to the OMR a proposed sequence of mixing and a proposed concrete mix design based on trial mixes by the concrete supplier. Perform the laboratory mix design with the observation and assistance from the OMR. There is no separate payment for this mix design.

10 Class 6500 Trial Mix: Before placing Class 6500 concrete in the deck, place one or more small batches of Class 6500 concrete in a part of the structure as directed by the RCE. Test air content, slump, unit weight, temperature, cylinder for 28-day compressive strength, and time of set. Repeat the trial batch procedure until all desired mix properties are achieved.

11 No payment is made for the trial batches. The Class 6500 concrete used in trial batches may be substituted for another class of concrete elsewhere in the project if it meets proper strength requirements, and in which case, it is paid for at the contract unit price of the concrete for which it is being substituted.

- 12 Mixing Sequence: Develop a proposed mixing sequence for review that ensures breakup and distribution of the dry densified silica fume. (Generally, the addition of part of the water, aggregates, and silica fume at mixing speed adequately disperses the silica fume. The remaining ingredients may then be added in a sequence to produce a desirable mix.)
- 13 Include both silica fume and fly ash as part of the cementitious material.
- 14 **Note 4:**
 Use Class 4000DS concrete for drilled shaft construction.
- 15 Design the mix for drilled shaft concrete and determine the proportions of cement, fine aggregate, coarse aggregate, water, and water reducing/retarding admixture that produces a workable concrete mix meeting the following criteria:
- Minimum cement per cubic yard.....625 lbs.
 - Slump.....7-9 inches
 - Max. water/cementitious ratio.....(see Table)
 - 28-day minimum compressive strength.....4000 psi
 - Air entraining admixture.....not required
 - Nominal coarse aggregate size..... ¾ inch
 - No. 67 aggregate gradation.....as required
- 16 Design concrete mix using approved ingredients intended for use on the project. Test trial mix for complete conformance with the Specifications.
- 17 Submit the proposed mix with test results showing full compliance with the Specifications to the OMR for review.
- 18 A Type G High-Range Water Reducing/Retarding admixture or a Type D Water Reducer-Retarder combined with a Type F High-Range Water Reducer may be used.
- 19 **Note 5:**
 Minimum Class 4000P concrete is preferred in non-prestressed precast items.

SUPPLEMENTAL SPECIFICATIONS

CONCRETE ENTRAINED AIR AND SLUMP PROPERTIES

701.2.12.3.1 Entrained Air and Slump Tests

Prior to discharge into forms, entrained air content (as determined by ASTM C231 or ASTM C173) and slump (as determined by ASTM C143) tests will be performed by the Department's representative on the first concrete truck to arrive at the site for every pour to ensure specification compliance. If the first truck arrives with material that is out of tolerance, a retest will be performed after elected steps as outlined below have been taken to correct out of tolerance loads of concrete. Subsequent trucks will be tested, corrected as outlined below, and retested upon arrival until the material meets Department specifications. Once test results show consistently acceptable results, future entrained air and slump testing will be at the discretion of the Department's representative and when making concrete test specimens for compressive strength testing.

Secure the sample for testing after one cubic yard of concrete has been discharged from the delivery vehicle. The one cubic yard can be used in the work provided that it meets Department specifications and is placed into equipment such as a concrete bucket and crane that conveys the concrete without introducing contamination or segregation. The Department will then obtain at least two cubic feet of concrete from the delivery vehicle in a sampling receptacle that conforms to the requirements of ASTM C31.

If either the entrained air content or slump testing yields a test result that is outside of the allowable range, the Department's representative will perform one retest on a different sample of the load in question. Before the retest, the contractor and/or ready mixed concrete producer may elect to take steps to bring the mix within specifications such as adding additional air entraining admixture, adding water that was held back at the plant, etc. When taking these corrective steps, ensure that all other specifications such as allowable time, required number of additional mixing revolutions, and maximum water/cementitious material ratio are in compliance with Department specifications. If the results of the retest are still outside of the allowable range, the load will be rejected and the Contractor's representative will be immediately informed of the test results. Ensure that the producer is immediately notified of the test results through a pre-established means of communication. If the results of the retest indicate passing properties then the concrete will be permitted to be used in the work.

Ensure that no additional cement is added to loads of concrete previously rejected for excessive water content or slump, with the exception of Class 2500 non-structural concrete, as indicated in **Subsection 701.4.6**.

Acceptance or rejection will be based on the results obtained from these tests. Sampling, fabrication, and curing of cylinders to be used for compressive strength testing will be performed as required per ASTM Standards and the Standard Specifications.

701.2.12.4 Non-conforming Concrete

701.2.12.4.1 Price Reduction

- 1 If the 28-day compressive strength or tensile strength of the concrete test cylinders falls below the expected design strengths, but is at least 90% of the design strength, a price reduction is applied on the quantity of concrete represented by the non-conforming cylinders determined from the following table. (This subsection does not apply to prestressed concrete, which due to complex design criteria is handled on a case-by-case basis.)

| Cylinder Test Results: | Price Reduction per cubic yard (Percent) X (Contract Unit Price) | |
|---|---|------------------------------|
| Percentage of Minimum Strength | With Contract Unit Price | Without Contract Unit Price* |
| 98.0 - 100.0 | 0% | 0% |
| 95.0 - 97.9 | 5% | 25% |
| 90.0 - 94.9 | 10% | 50% |
| <p>* If there is no contract unit price for concrete, use (percent reduction) x (supplier's invoice unit cost).</p> <p>The BCE may approve use of concrete test method SC-T-49 to determine the accepted strength if the concrete test cylinders have been considered non-conforming.</p> <p>The total amount of the price reduction will not be less than \$500.00.</p> | | |

- 2 If any cylinder test result is below 90%, take cores in the presence of the BCE or RCE from the concrete in the structure that is represented by the non-conforming test cylinders in order to evaluate the strength of the concrete in place. Ensure that test cores are taken, conditioned, and tested in accordance with the requirements of **Subsection 701.2.12.4.2.2**.

701.2.12.4.2 Procedure for Testing Non-conforming Concrete

701.2.12.4.2.1 Limits of Questionable Concrete

- 1 The limit of questionable concrete is determined by using concrete test method **SC-T-49**. Acceptance is solely based on the compressive strength of the cores removed from the in-place concrete, unless authorized otherwise by the BCE.

701.2.12.4.2.2 Obtaining Cores

- 1 Have the OMR or an independent firm, accredited by AASHTO, remove the cores from the structure in the presence of representatives of all affected parties. The BCE will determine the location(s) of the test cores that best represent the concrete in question. Take three cores (3 to 4 inches in diameter), sized to match the testing equipment used, from each area of concrete that produced a test cylinder with test strength less than 90% of the required strength. Take care to avoid damaging reinforcing steel. Properly label cores before shipment. Obtain and test cores at no expense to the Department.

701.2.12.4.2.3 Conditioning and Testing Cores

- 1 Deliver cores to the OMR or an independent testing laboratory accredited by AASHTO.
- 2 Have cores tested in accordance with AASHTO T 24. Provide a written report on the laboratory test results to all affected parties.

701.2.12.4.2.4 Acceptance of Concrete

- 1 Acceptance of the concrete from which the cores are taken is based on the core test results. If access to the concrete is not practical for obtaining cores or the taking of cores would result in irreversible damage to the structure, the BCE may approve concrete test method **SC-T-49** to determine the strength of the concrete.
- 2 If the **SC-T-49** test results or the core test results are below 90%, but are equal to or greater than 85% of the design strength, obtain a design analysis based on the reduced strength from the Designer-of-Record. Based on the design analysis, the BCE will determine if the concrete can remain in place. If the concrete test results are less than 85% of the design strength, remove the concrete unless authorized otherwise in writing by the BCE.
- 3 If non-conforming concrete is allowed to remain in-place, a price reduction on the quantity of concrete in question is determined by the following table.

| Price Reduction for Non-conforming Concrete Left In-Place | | |
|--|---|--------------------------------|
| Core Test Results: * | Price Reduction per cubic yard (Percent) X (Contract Unit Price) | |
| Percent of Minimum Strength | With Contract Unit Price | Without Contract Unit Price ** |
| 98.0 -100.0 | 0% | 0% |
| 95.0 - 97.9 | 5% | 25% |
| 90.0 - 94.9 | 10% | 50% |
| 85.0 - 89.9 | 15% *** | 80% |
| * Or SC-T-49 if approved by the BCE. ** If there is no contract unit price for concrete, use (percentage) x (supplier's invoice unit cost). *** Use 15% of contract unit price or 80% of supplier's invoice unit cost, whichever is greater. The total amount of the Price Reduction will not be less than \$500.00. | | |

701.2.12.5 Changes in Mix Design

- 1 When changes are made in the mix design, furnish the new proportioning values for batching purposes to the OMR for review.

701.3 Equipment

701.3.1 Equipment, Inspection, and Approval

- 1 Have all equipment specified herein inspected and approved before use. Schedule such inspections at least annually and at other times considered necessary by the RCE.

701.3.2

701.3.3

701.3.2 Weighing Equipment

- 1 At all batch plants, provide equipment with a positive means of weighing ingredients in each batch of concrete.
- 2 Weigh individual cementitious material to not less than 99% of the required weights.
- 3 Ensure that the weight of individual aggregates is within $\pm 2\%$ of the required weight and the total weight of aggregate is within $\pm 2\%$ of the total required weight. Use beam, springless-dial, or load cell scales for weighing aggregates and cement. Make certain that scales are accurate to within 0.5% when used for cement and to within 1.0% when used for aggregate under operating conditions throughout the range of use. When beam scales are used, provide a device such as a "tell-tale" dial for indicating when the load in the weighing hopper is approaching the required weight. Use poises de- signed to lock in any position to prevent accidental change of position.
- 4 Provide dust tight enclosure for dial scales. Ensure that the chart is made from a durable material and has good readability.
- 5 Periodically have scales used in batching Portland cement concrete checked for accuracy by the Division of Weights and Measures of the State Department of Agriculture or by other qualified scale service agents. Post on the scales or in the batching room a statement certifying as to their accuracy with the date of inspection. Do not allow the interval between inspections to exceed 12 months.
- 6 Ensure that the cement weighing hopper is properly sealed and vented to preclude dusting during weighing operations.

701.3.3 Central Mixing Plant

- 1 Thoroughly mix concrete in a batch mixer of an approved size and type that ensures a uniform distribution of the materials throughout the batch. Use plants that are listed on the most recent edition of *SCDOT Qualified Product List 28*.
- 2 Ensure that there is adequate water storage. Make certain that the mixer is equipped with a device to accurately weigh or measure and automatic control the quantity of water used in each batch. Ensure that the device used is accurate, and so calibrated that under all operating conditions, it is accurate to within 1% of the quantity of water required for the batch. Furnish the Department's inspector with facilities for checking the water measuring equipment whenever deemed necessary by the RCE. Clearly mark scales or other means used to measure water to accurately show the quantity of water used. Ensure that there is no loss of water from the time it is measured until it is deposited in the mixer drum. Make certain that the water supply is automatically shutoff while the water is being discharged into the mixer. Use a mixer with an acceptable timing device capable of being locked and that does not permit the batch to be discharged until the specified mixing time has elapsed.

701.3.3**701.3.4**

- 3 Maintain mixers in good working condition. Repair mixers when necessary to ensure that the concrete is of uniform quality. Examine mixers for change in condition due to accumulation of hard concrete or mortar and for wear of the blades. Replace the pick-up and throw-over blades when any part or section is worn 1 inch or more below the original height of the manufacturer's design. If requested by the OMR, provide a copy of the manufacturer's design, showing dimensions and arrangements of blades.
- 4 Use mixers equipped with a separate dispenser for each type of admixture.

The dispensers may operate either automatically or manually, but regardless of which type is used, make certain that they are capable of measuring and placing exactly and consistently the desired amount of admixtures in each batch.

701.3.4 Truck Mixers

- 1 Make certain that all truck mixers are pre-approved by the SCDOT or NRMCA and display a valid approved inspection sticker.
- 2 Ensure that the manufacturer's rating plate is attached on all truck mixers and the mixing speed and agitating speed are clearly visible and legible on the plate. If the speeds are not legible or if truck mixer does not have a rating plate, provide the OMR a written document from the truck mixer manufacturer stating the mixing and agitating speeds.
- 3 Use truck mixers capable of combining the ingredients of the concrete within the specified number of mixing revolutions into a thoroughly mixed and uniform mass and discharging the concrete with a degree of uniformity satisfactory to the RCE.
- 4 Do not exceed the manufacturer's rating for the volume of mixed concrete permitted in the drum of truck mixer indicated on the capacity plate. Ensure that the National Ready Mixed Concrete Association (NRMCA) plate is accessible, clear, and legible at all times. Ensure agitators are capable of producing concrete with a degree of uniformity to the satisfaction of the RCE.
- 5 If the equipment does not have an attached rating plate with maximum capacities. The approved capacity as a mixer and as an agitator will be assumed from the following table.

| Maximum Gross Volume of Drum (cubic feet) | Maximum Capacity (cubic yards) | |
|---|--------------------------------|-------------|
| | As Mixer | As Agitator |
| 261 | 6.0 | 7.75 |
| 306 | 7.0 | 9.25 |
| 329 | 7.5 | 9.75 |
| 352 | 8.0 | 10.50 |

(table continued on the next page)

(table continued from the previous page)

| Maximum Gross Volume of Drum (cubic feet) | Maximum Capacity (cubic yards) | |
|---|-----------------------------------|-------------|
| | As Mixer | As Agitator |
| 376 | 8.5 | 11.25 |
| 399 | 9.0 | 12.00 |
| 423 | 9.5 | 12.75 |
| 446 | 10.0 | 13.25 |
| 493 | 11.0 | 14.75 |
| 540 | 12.0 | 16.00 |
| 587 | 13.0 | 17.50 |
| 634 | 14.0 | 19.00 |
| 681 | 15.0 | 20.25 |

- 6 If the volumes are determined using the table above, provide with each truck the proper documentation to be used instead of the manufacturer's rating plate showing the maximum mixing and agitating capacity.
- 7 Use truck mixers equipped with a water system and measuring device. Make certain that the device permits ready access and can accurately determine the quantity of water used. Use a water-measuring device that can accurately measure water in the tank to within 1.0% when the truck mixer is stationary and essentially level.
- 8 Ensure that truck mixers and agitators of the revolving drum type are equipped with a hatch in the periphery of the drum shell that will permit access to the inside of the drum for inspection, cleaning, and repair of the drum and blades.
- 9 Use truck mixers that have an electrically or mechanically actuated revolution counter that can be reset to zero. Make certain that this counter is mounted in a position such that it can be read from the ground.
- 10 Maintain truck mixers in good working condition. Repair when necessary to ensure that the concrete is of uniform quality. Replace blades when any part or section is worn 1 inch or more below the original design. If requested by the OMR, provide a copy of the manufacturer's design, showing dimensions and arrangements of blades.

701.4 Construction

701.4.1 Care and Storage of Concrete Aggregates

- 1 Handle and store concrete aggregates in a manner that prevents intermixing, segregation, and contamination by foreign materials. Handle and stockpile each aggregate component from a different source or grading separately. Clear vegetation and other extraneous matter from stockpile sites, so that they have natural ground bottoms, and ensure that they are generally smooth, firm, and well drained.

701.4.1

- 2 Do not use the bottom 1-foot of any stockpile with a natural ground bottom except under direct supervision of the RCE. If excessive segregation is likely because of the stockpiling of an aggregate, construct the stockpile in layers not to exceed 3 feet in depth.

701.4.2 Storage of Cement

- 1 Store bulk cement in weatherproof bins or silos that protect the cement from dampness and provide for the free flow of the cement. If the OMR authorizes the use of bagged cement, store it in weatherproof buildings or temporary store it in the open on a raised platform with ample waterproof flooring and covering.
- 2 At a batching plant with two or more silos in which different types of cement or cementitious materials is stored, place a sign at each fill inlet indicating the type of cement stored therein. Make the sign from a durable material with raised, indented, or cut letters a minimum of 2 inches high and ¼ inch thick or deep. Ensure that the sign clearly identifies the material that is in the silo.
- 3 If concrete is to be proportioned at the work site and is only for the Department's use, keep accurate records of the deliveries of cement and of its use in the work. Provide copies of these records to the RCE and OMR in such form as they may require.

701.4.3 Measuring Materials

701.4.3.1 Portland Cement

- 1 Measure Portland cement and other cementitious materials by weight unless otherwise specified. Weigh the cementitious materials on scales meeting the requirements of **Subsection 701.3.2** and are not used to weigh other materials. If bagged cement is authorized, measure it in bags packed by the manufacturer. From time to time, weigh full bags as a check on the net weight. Prepare batches that do not require fractional bags of cement unless all the cement for each batch is weighed.

701.4.3.2 Water

- 1 Measure water by volume or by weight through an approved measuring system. Use a measuring system with a metering or weighing device capable of incorporating into the batch the predetermined quantity of water with an accuracy of 1.0% of the quantity of water required for the batch. Assume water to weigh 8.33 pounds per gallon.

701.4.3.3 Fine and Coarse Aggregate

- 1 Measure fine and coarse aggregates separately by weight on scales meeting the requirements of **Subsection 701.3.2**. In measuring aggregates, make allowance for water in the aggregates. For determinations of the moisture content of aggregates, use automatic sensing devices if available; otherwise, take representative samples and investigate individually or combined in a composite sample.

701.4.3.4 Admixtures

- 1 Dispense admixtures into the batch as a solution of uniform concentration and in the amounts recommended by the manufacturer. Use properly equipped sight-tube dispensers with a graduation strip or strips that are labeled in terms of ounces or ounces per hundred pounds of cement. Identify graduated strips as to the rate at which the admixture is being measured for the particular diameter of the tube being used.
- 2 Calibrate meter and timing dispensers by obtaining a metered sample and checking the accuracy of the system. Have the equipment checked and approved

701.4.3.4

701.4.3.4

during the annual inspection and at other times when deemed necessary or as directed by the RCE.

- 3 Maintain the accuracy of all systems to within $\pm 3\%$. Discharge the admixture into the stream of water entering the mixer drum or into the pre-measured or pre-weighed water for each batch. Take precautions to prevent the dilution of the admixture in storage by rain and condensation. For actual control, measure the air content with air meters only. Add additional admixtures at any time to achieve the proper amount of entrained air.
- 4 When adding Types A, C, D, or E admixtures, ensure that the dispensing equipment and procedure adds the admixture after the dispensing of the air entraining agent is complete and some mixing of the concrete has occurred. When adding Types F or G admixture, do not add the admixture agent until after all of the materials are in the mixer and have been mixed for 1 minute if in a truck mixer, for 15 seconds if in a central-mix mixer, or at approximately the midpoint of the primary mixing portion of the auger mixing chamber on a mobile concrete mixer unit.

701.4.4.2

701.4.4 Concrete Batching and Mixing

701.4.4.1 General

- 1 When concrete is furnished by a transit or central-mix plant, use batching equipment that is sufficient to weigh a load of the required size in less than 15 minutes.
- 2 Make certain that an SCDOT-certified concrete field technician is present at the plant when concrete is being produced for SCDOT work. The SCDOT-certified concrete field technician may be an employee of the Contractor, the concrete supplier, or an independent testing laboratory. While concrete is being produced for SCDOT work, ensure that the SCDOT-certified concrete field technician's sole, full-time responsibility is to maintain quality control records and conduct physical testing of concrete and its constituent materials.
- 3 Ensure that an SCDOT-certified concrete field technician completes and signs Form 700.04 for the first load of each class of concrete delivered to the job site each day. After the completion of Form 700.04 for the first delivered load, subsequent loads of each class of concrete will require Form 700.04 or an OMR pre-approved batch ticket containing the appropriate information. A batch ticket may be pre-approved for use in SCDOT work through the Structural Materials Engineer if the batch ticket format contains at a minimum: date and time batched, load size, ticket number, aggregate moistures, amount of free water in aggregates, design target weights or measures for all materials, batched variances from targets listed as a percentage for all materials, designed water/cementitious materials ratio, batched water/cementitious materials ratio, designed batch water in gallons, actual batch water in gallons, and water in gallons held back from target value at the plant that can be added at the job site.

701.4.4.2 Batching and Mixing in Cold Weather

- 1 Before starting work on the project, submit a written *Cold Weather Batching and Mixing Plan* developed in conjunction with the concrete supplier and to be used when the atmospheric temperature is below 35°F (determined by the RCE).

701.4.4.2

- 2 At a minimum, include in the plan the methods and equipment employed to meet the following requirements and restrictions:
 - Do not batch concrete with aggregates that contain frozen particles.
 - Do not heat mixing water to a temperature exceeding 170°F at discharge into the mixer.
 - Heat aggregates by either steam or dry heat.
 - Use heating apparatus to heat the aggregates uniformly and avoid hot spots.
 - Make certain that the temperature of the batched concrete is at least 50°F when placed in the forms.

The RCE may add other requirements to the plan if deemed necessary.

- 3 Batch concrete only after the plan has been accepted, and the RCE has specifically authorized the batching.

701.4.4.3 Batching and Mixing in Hot Weather

- 1 Before starting work on the project, submit a written *Hot Weather Batching and Mixing Plan* developed in conjunction with the concrete supplier to prevent the concrete mix temperature from exceeding 90°F measured before placement in the forms, unless specified otherwise. For Class 2500 concrete, do not allow the temperature of the concrete to exceed 95°F. For mass concrete pours, do not allow the mix temperature to exceed 80°F as measured at discharge into the forms. This requirement does not apply to concrete used in precast/prestressed members.
- 2 The plan may include the following methods and equipment to meet the mix temperature requirements:
 - Use Type II cement.
 - Sprinkle coarse aggregate with water to cool by evaporation.
 - Use chilled mixing water or shaved ice to replace part of the mixing water.

- 3 Ensure that the plan conforms to the applicable requirements of ACI 305R, *Hot Weather Concreting*.

701.4.4.4 Central Plant Mixing

- 1 Thoroughly mix concrete in a central mixer of an approved plant. Ensure that the period of mixing after all materials including water are in the drum exceeds 1½ minutes. During the mixing period, operate the drum at speeds specified by the mixer manufacturer and shown on the nameplate on the machine.
- 2 Mix concrete only in quantities required for immediate use. Transport the mixed concrete to the work site in a truck mixer operating at agitating speed.

701.4.4.5 Truck Mixing

- 1 After all materials, including water, have been placed in a truck mixer, rotate drum for not less than 70 revolutions at the mixing speed designated by the truck mixer manufacturer and shown on the rating plate. Mix concrete at the batching plant or at the job site. After mixing or while in transit between the plant and the work site, rotate the drum at agitating speed of 2 to 6 rpm or at the speed designated for agitation by the manufacturer.

701.4.4.6

701.4.7

701.4.4.6 Wash Water Stabilizers

- 1 Ready mix concrete producers may use mixer drum wash water stabilizer agents in truck and central mix drums. Use products that appear on the most recent edition of *SCDOT Qualified Product List 32*. Make certain that the stabilizing agents are used in accordance with the most recent edition of *SCDOT Qualified Product Policy 32*.
- 2 The RCE or the OMR may disallow the use of mixer drum wash water stabilizers if the Department's policy is not strictly adhered to or technical problems are encountered because of using a stabilizer.

701.4.4.7 Mobile Concrete Mixing Plants

- 1 Use a truck mounted mobile Portland cement concrete plant designed for automatic volume proportioning of the concrete materials and for mixing the concrete for immediate use at the work site for incidental construction and only when authorized by the OMR. If authorized, ensure that the plant provides a satisfactory rate of production and is capable of combining the concrete ingredients into a thoroughly mixed and uniform mass and of discharging the concrete without segregation.

701.4.5 Consistency

- 1 Provide compatible pozzolans and/or admixtures as necessary to obtain the appropriate workability and consistency at no additional cost to the Department. Provide the RCE and the OMR with written documentation from the concrete supplier stating that all products in the concrete mix are compatible.

701.4.6 Slump

- 1 Except for Class 2500 concrete and unless otherwise specified, provide concrete that has a maximum slump of 4 inches when measured in accordance with ASTM C 143. In any case, do not exceed the water to cementitious material ratio for the appropriate class of concrete shown in the Structural Concrete Table in **Subsection 701.2.12.2**.
- 2 For pumped concrete, the slump is measured at the truck.
- 3 In the event additional water is required to obtain the specified slump at the work site, the RCE may approve adding water from an acceptable water supply at the rate of 1 gallon per cubic yard per inch of desired slump, but not to exceed the maximum water to cementitious material ratio shown in the table in **Subsection 701.2.12.2**. When additional water is added, make certain that the truck mixer drum turns a minimum of 25 revolutions at mixing speed before discharge of the concrete.
- 4 For Class 2500 concrete with an initial slump between 4 to 6 inches, additional cement may be added at the work site at the rate of 20 pounds of cement per cubic yard of concrete per inch of slump over 4 inches to attempt to bring the slump down to the maximum of 4 inches. Batches of Class 2500 concrete with slumps greater than 4 inches after the allowable addition of cement will not be accepted for Department use, unless otherwise permitted by these specifications or the Special Provisions.

701.4.7 Water Reducers

- 1 A water reducer may be used to increase the slump of concrete. A Mid-Range Water Reducer (MRWR) may be used to increase the slump to a maximum of 6 inches. A High-Range Water Reducer (HRWR) may be used to increase the slump to a maximum of 9 inches.

701.4.7

701.4.7

In any case, do not allow the slump to exceed the maximum slump for the following items:

- Maximum 6" slump for concrete in bridge decks.
 - Maximum 9" slump for seal concrete and in drilled shaft concrete.
 - Maximum 9" slump for prestressed concrete.
- 2 Use MRWR or HRWR admixtures listed on the most recent edition of *SCDOT Qualified Product List 5*. Provide to the RCE for prior approval the admixture manufacturer's product data sheet that clearly states the product is intended for use as a MRWR or a HRWR. Use MRWR and HRWR admixtures strictly in accordance with the manufacturer's recommendations and the limitations specified in this subsection.
 - 3 Type F or Type G admixtures may be added to concrete to increase workability and/or to reduce the water to cementitious material ratio. Type F is a HRWR, and Type G is a High Range Water Reducer-Retarder. If these admixtures are used, add them at the work site just before discharge, and mix concrete for a minimum of 30 seconds per cubic yard of concrete in the mixer after each addition of an admixture. Measure the slump of the concrete before the addition of the high-range admixture, and make certain not to exceed the maximum slump limits indicated above. Discontinue or avoid the use of admixtures when there is any indication of excessive flow, bleeding, or segregation. The admixture may be added a second or third time to re-establish mixture flow if the maximum time for placing the concrete after the mix water is added has not expired.

701.4.8 Water Reducer-Retarders

- 1 A water reducer-retarder admixture may be added to concrete mixes to reduce the water content and shrinkage in the concrete, improve its workability, retard the initial set of the concrete, and/or reduce the rate of internal heat development in concrete pours without sacrificing quality or strength.
- 2 Use a water reducer-retarder, Type D or Type G complying with **Subsection 701.2.6** in concrete deposited underwater, and also in concrete that is not likely to reach its final position in the forms before initial set takes place. Ensure that proportioning and dispensing of the admixture is in accordance with **Subsection 701.2.6**.

701.4.9 Fly Ash and Water-Granulated Blast-Furnace Slag

- 1 The addition of fly ash or water granulated blast-furnace slag is allowed in the concrete mix if the following requirements are met when using these materials:
 - A. Fly ash or water-granulated blast-furnace slag may replace allowable percentages of Type I, Type II, or Type III Portland cement. Do not use fly ash or slag replacement for mixes using Type I (SM) or any other blended cement.
 - B. Remove forms in accordance with **Subsection 702.4.5**.
 - C. When fly ash is used to replace the Portland cement, replace at a ratio of not less than 1.2:1 by weight, and do not replace more than 20% of the cement originally called for in the mixture.
 - D. When water-granulated blast-furnace slag is used to replace Portland cement, replace at a ratio of 1:1 by weight, and do not replace more than 50% of the cement originally called for in the mixture.

701.4.9

701.6

- E. Submit a mix design to the OMR for review a minimum of 7 calendar days in advance of batching. Indicate in the submittal the amount of cement to be removed, the material that will replace it, and compressive strength results of the mix.
- F. After batching begins and as concrete is delivered to the work site, make certain that the concrete contains the specified entrained air content at the time it is discharged from the transit mixer. Do not use concrete with non-conforming air content.
- G. To ensure accurate batching, provide separate storage bins, conveying devices, weighing equipment, and weighing procedures for each material (fly ash or slag) used.
- H. Provide fly ash from sources that appear on the most recent edition of *SCDOT Qualified Product List 3*. Furnish certified mill test reports and shipping tickets from the supplier for each shipment.
- I. Provide slag from sources that appear on the most recent edition of *SCDOT Qualified Product List 6*.

701.5 Measurement

- 1 The quantity for the pay item Concrete for Structures - Class (as specified) is the volume of specified concrete within the neat lines of the structure as shown on the Plans or as revised by the RCE (excluding precast/prestressed members, bridge barrier parapet, bridge barrier parapet transitions, and drilled shaft concrete) and is measured by the cubic yard (CY) of concrete, complete, and accepted. Deductions are made for the volume of embedded items, except for reinforcing steel; however, no deduction is made for edge chamfers of $\frac{3}{4}$ inch or smaller.
- 2 Measurement for the quantity of concrete in bridge slabs is computed from the neat line dimensions shown on the Plans with no allowance for form deflection. No additional payment is made for extra concrete required by the use of permanent steel bridge deck forms or for the SIP forms themselves.
- 3 The costs for concrete used in precast/prestressed members, bridge barrier parapet, bridge barrier parapet transitions, and drilled shafts, including the cost of designing the mix, testing, engaging the testing laboratory, and furnishing materials for testing is included in the contract unit bid price for the applicable pay item.

701.6 Payment

- 1 Payment for the accepted quantity of Concrete for Structures - Class (as specified), measured in conformance with **Subsection 701.5**, is determined using the contract unit bid price for each pay item. Payment is full compensation for furnishing and placing the Class of concrete as specified or directed and includes costs of the mix design, sampling, and testing; furnishing, storing, batching, mixing, and transporting concrete materials; admixtures; falsework and forms (including SIP forms); surface finishing and curing; quality control personnel and equipment; and all other materials, labor, equipment, tools, supplies, transportation, and incidentals necessary to fulfill the requirements of the pay item in accordance with the Plans, the Specifications, and other terms of the Contract.
- 2 Concrete is paid for at 100% of the contract unit bid price upon completion of the Initial Surface Finish.

701.6**701.6**

- 3 Unless otherwise specified, payment for concrete includes the cost of pipe drains, French drains, weep holes, expansion joints, expansion joint materials, flashing, pipes, conduits, anchors, and other similar material. Payment for concrete also includes the cost of removing and disposing of portions of existing structures designated on the Plans to be widened or reconstructed and the costs of drilling for dowels or expansion bolts.
- 4 Payment for the item Concrete for Structures includes all direct and indirect costs and expenses required to complete the work.
- 5 Pay items under this section include the following:

| Item No. | Pay Item | Unit |
|-----------------|---|-------------|
| 7011100 | Concrete for Structures – Class 3000 (Roadway) | CY |
| 7011105 | Concrete for Structures – Class 3000 (Retaining Wall) | CY |
| 7011200 | Concrete for Structures – Class 3000 (Bridge) | CY |
| 7011300 | Concrete for Structures – Class 2500 | CY |
| 7011400 | Concrete for Structures – Class 4000 | CY |
| 7011400 | Concrete for Structures – Class 4000 | CY |
| 7011401 | Concrete for Structures – Class 4000 (Retaining Wall) | CY |
| 7011402 | Concrete for Structures – Class 4000 (Culvert) | CY |
| 7011403 | Concrete for Structures – Class 4000 (Roadway) | CY |
| 7011500 | Concrete for Structures – Class 4000S | CY |
| 7011501 | Concrete for Structures – Class 4000P | CY |
| 7011510 | Concrete for Structures – Class 4000DS For Drilled Shafts | CY |
| 7011600 | Concrete for Structures – Class 5000 | CY |
| 7011630 | Concrete for Structures – Class 6500 | CY |
| 7011640 | Concrete for Structures – Class 7000 | CY |

| Gradation of Coarse Aggregates | | | | | | | | | | | | |
|--|---------------|----------|----------|----------|----------|----------|----------|----------|----------|----------|--|--|
| Percentage by Weight Passing Sieves Having Square Openings | | | | | | | | | | | | |
| Sieve Designation | Aggregate No. | | | | | | | | | | | |
| | CR-14 | 5 | 56 | 57 | 67 | 6M | 8M | 78 | 789 | 89M | | |
| 2-inch | 100 | -- | -- | -- | -- | -- | -- | -- | -- | -- | | |
| 1½-inch | 95 - 100 | 100 | 100 | 100 | -- | -- | -- | -- | -- | -- | | |
| 1-inch | 70 - 100 | 90 - 100 | 90 - 100 | 95 - 100 | 100 | 100 | -- | -- | -- | -- | | |
| ¾-inch | -- | 20 - 55 | 40 - 85 | -- | 90 - 100 | 90 - 100 | 100 | 100 | 100 | -- | | |
| ½-inch | 35 - 65 | 0 - 10 | 10 - 40 | 25 - 60 | -- | -- | 95 - 100 | 90 - 100 | 95 - 100 | 100 | | |
| ⅜-inch | -- | 0 - 5 | 0 - 15 | -- | 20 - 55 | 0 - 20 | 75 - 100 | 40 - 75 | 80 - 100 | 98 - 100 | | |
| No. 4 | 10 - 40 | -- | 0 - 5 | 0 - 10 | 0 - 10 | 0 - 5 | 10 - 35 | 5 - 25 | 20 - 50 | 20 - 70 | | |
| No. 8 | -- | -- | -- | 0 - 5 | 0 - 5 | -- | -- | -- | -- | 2 - 20 | | |
| No. 16 | -- | -- | -- | -- | -- | -- | 0 - 5 | 0 - 5 | 0 - 6 | -- | | |
| No. 100 | -- | -- | -- | -- | -- | -- | 0 - 2 | -- | 0 - 2 | 0 - 3 | | |

A - 4

| Gradation of Fine Aggregates | | | | |
|---|----------------------|---------------|--------------|--------------|
| Percentage by Weight Passing Sieves Having Square Openings | | | | |
| Sieve Designation | Aggregate No. | | | |
| | FA-10 | FA-10M | FA-12 | FA-13 |
| ½-inch | -- | -- | -- | -- |
| ¾-inch | 100 | 100 | 100 | 100 |
| No. 4 | 96 - 100 | 95 - 100 | 90 - 100 | 90 - 100 |
| No. 8 | 75 - 100 | 84 - 100 | -- | -- |
| No. 16 | 55 - 98 | 45 - 95 | 50 - 86 | 40 - 80 |
| No. 30 | 25 - 75 | 25 - 75 | -- | -- |
| No. 50 | 5 - 30 | 8 - 35 | 2 - 20 | 0 - 10 |
| No. 100 | 0 - 9 | 0.5 - 20 | 0 - 5 | 0 - 3 |
| No. 200 | 0 - 3 | 0 - 10* | -- | -- |

* Dust of fracture essentially free from clay or shale, final job site testing only.

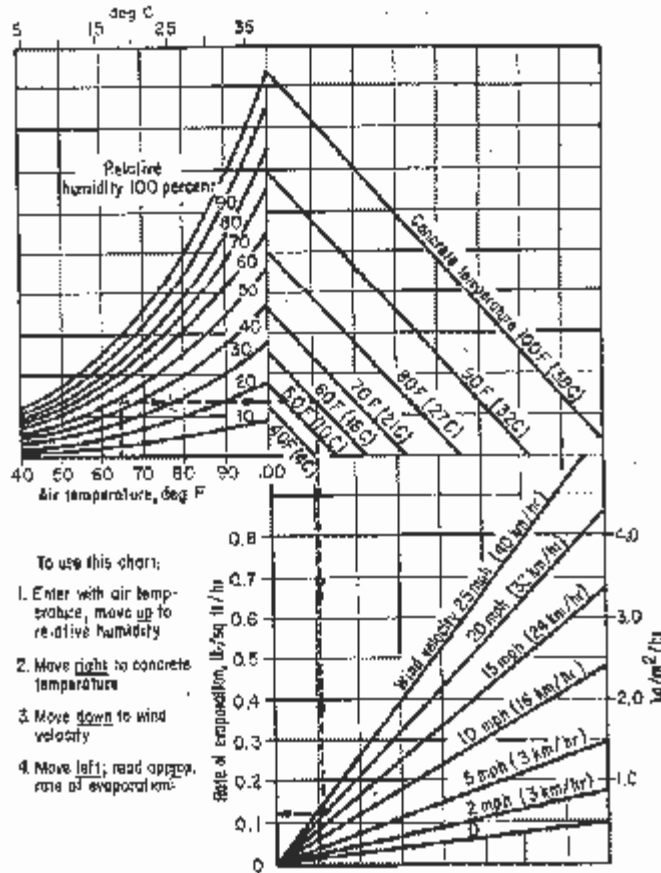

Nomograph for Determining Rate of Evaporation

This chart provides a graphic method of estimating the loss of surface moisture due to concrete and air temperatures, relative humidity, and wind velocity. To use the chart, follow the four steps outlined. If the rate of evaporation approaches 0.2 lbs. /ft.²/hr., precautions against plastic shrinkage cracking are necessary.

Chapter 5

Supplemental Specifications, Department Memos, and Changes

| Date | Topic | Page Number |
|-------------|---|--------------------|
| 4/8/08 | Surface Smoothness of Bridge Decks and Approach Slabs | 3 |
| 4/5/10 | Concrete Batching & Mixing | 5 |
| 4/1/13 | Concrete Structures – Preformed Joint Filler | 6 |
| 5/5/14 | Portland Cement and Portland Cement Concrete | 7 |
| 8/1/14 | Class 5000 Structural Concrete | 8 |
| 2/1/15 | Concrete Entrained Air and Slump Properties | 9 |
| 8/3/15 | Section 703 Reinforcing Steel | 10 |
| 7/1/18 | Concrete Placement in Cold and Hot Weather | 15 |
| 7/1/18 | Concrete Batching & Mixing in Cold and Hot Weather | 17 |
| 1/1/19 | Concrete Structures – Preformed Joint Filler | 19 |
| 7/1/19 | Fine and Coarse Aggregate | 20 |
| 7/1/19 | Volumetric Concrete Mixers | 21 |
| 4/20/20 | COVID-19 Memorandum | 23 |
| 7/1/20 | Reinforcing Steel | 25 |
| 1/1/21 | Concrete Mix Design | 31 |
| 1/1/21 | Falsework/Forming Systems | 33 |
| 7/1/21 | Fine and Coarse Aggregate | 35 |
| 7/1/21 | Grooved Surface Finish | 36 |
| 7/1/21 | Removal of Falsework and Forms | 37 |
| 7/1/21 | High-Tensile-Strength Seven-Wire Strand | 38 |
| 1/1/22 | Mass Concrete Placement | 39 |

Surface Smoothness of Bridge Decks and Approach Slabs

SCDOT Designation: SC-M-701 (04/08)

1. SCOPE

- 1.1. This standard describes the smoothness requirements for bridge decks. The riding surfaces subject to this standard include all traffic lanes, all full-width acceleration and deceleration lanes, and lanes planned for future use on both bridge decks and approach slabs.
-

2. REFERENCED DOCUMENTS

- 2.1. **SC-T-124**, Operation of the Cox Model C8200 Electronic Profilograph for Surface Measurement
-

3. DEFINITIONS

- 3.1. *Profile Index* – Inches per Mile of total roughness in excess of the blanking band.
 - 3.2. *Blanking Band* – A band of uniform height with its longitudinal center positioned optimally between the highs and lows of the surface record depicting at least 100 feet of pavement.
-

4. PREPARATION OF THE TESTING SURFACE

- 4.1. Provide a surface clean of all debris such as sand and aggregate and make the site accessible to SCDOT's Office of Materials and Research (OMR) personnel performing the test prior to their arrival. Remove any materials stored or blocking the areas to be tested.
-

5. REQUEST FOR TESTING

- 5.1. When needed, schedule smoothness testing through the Resident Construction Engineer (RCE), who will then make arrangements with the Pavement Evaluation Unit within OMR. If OMR personnel arrive at the scheduled testing time and find the site is not suitably prepared for testing as given in Subsection 4, above, correct the deficiency within 60 minutes. After 60 minutes, the testing must be rescheduled and the Contractor will reimburse the Department in the amount of \$500 for the additional site visit.
-

6. TESTING

- 6.1. The Pavement Evaluation Unit of OMR will determine a Profile Index for each wheelpath for nominal 300-foot test sections. Partial sections will be analyzed and reported as given in **SC-T-124**. Sections that contain individual bumps in excess of the maximum values given herein will also be noted. The RCE and the Contractor will receive copies of the profile chart and test results.

7. REQUIREMENTS FOR SMOOTHNESS

- 7.1. The maximum allowable Profile Index value for acceptable smoothness for any individual wheelpath is 10 inches per mile utilizing the 0.2-inch blanking band for each 300-foot nominal test section. All individual bumps and depressions exceeding a cutoff height of 0.3 inches from a chord of 25 feet must be corrected regardless of Profile Index. In addition to these requirements for longitudinal smoothness, the surface will have deviations no greater than 0.25 inches in 10 feet when measured using a 10-foot straightedge placed transversely across any lane.

8. CORRECTIVE ACTION

- 8.1. When any measured surfaces fail to meet the criteria given in Subsection 7, above, take corrective action at no expense to the Department. Submit a written plan of corrective action to the RCE and receive approval from the RCE prior to taking any corrective action. However, approval of any corrective plan in no way relieves any responsibility for meeting these smoothness requirements. Any corrective plan that reduces the concrete cover by more than 0.50 inches from that shown in the Plans is not acceptable.
- 8.2. After corrective action, the surface will be retested by the Department to determine if the rideability requirements have been met. If the surface is tested and reported more than three times, including the initial rideability test, the Contractor shall reimburse the Department for each additional test in the amount of \$500.

9. GROOVED SURFACE FINISH

- 9.1. When a grooved surface finish is required, do not apply it until all requirements for rideability have been met.

CONCRETE BATCHING AND MIXING

Delete subsection 701.4.4.1 Concrete Batching and Mixing – General, of the Standard Specifications in its entirety and replace it with the following:

701.4.4 Concrete Batching and Mixing**701.4.4.1 General**

- 1 When concrete is furnished by a transit or central-mix plant, use batching equipment that is sufficient to weigh a load of the required size in less than 15 minutes.
- 2 Make certain that an SCDOT-certified concrete field technician is present at the plant when concrete is being produced for SCDOT work. The SCDOT-certified concrete field technician may be an employee of the Contractor, the concrete supplier, or an independent testing laboratory. While concrete is being produced for SCDOT work, ensure that the SCDOT-certified concrete field technician's sole, full-time responsibility is to maintain quality control records and conduct physical testing of concrete and its constituent materials.
- 3 Ensure that an SCDOT-certified concrete field technician completes and signs *Form 700.04* for the first load of each class of concrete delivered to the job site each day. After the completion of *Form 700.04* for the first delivered load, subsequent loads of each class of concrete will require *Form 700.04* or an OMR pre-approved batch ticket containing the appropriate information. A batch ticket may be pre-approved for use in SCDOT work through the Structural Materials Engineer if the batch ticket format contains at a minimum: date and time batched, load size, ticket number, aggregate moistures, amount of free water in aggregates, design target weights or measures for all materials, actual batch weights or measures for all materials, batched variances from targets listed as a percentage for all materials, designed water/cementitious materials ratio, batched water/cementitious materials ratios, designed batch water in gallons, actual batch water in gallons, and water in gallons held back from target value at the plant that can be added at the job site.
- 4 Except for Class 2500 concrete, prestressed concrete, and precast concrete, the Department will not accept concrete unless a completed *Form 700.04* or preapproved batch ticket that is signed and certified by the SCDOT-certified concrete technician, accompanies the delivery of the concrete. If a pre-approved batch ticket is being used and conditions warrant that the use of a batch ticket is unacceptable to the RCE, the SCDOT-certified concrete technician will discontinue using the batch ticket for acceptance and return to the use of *Form 700.04* until such time that the deficiencies of the batch ticket have been resolved and accepted by the RCE.
- 5 Provide sufficient advance notification to the RCE as to the name of the plant supplying the concrete in order to permit time to make the necessary arrangements for inspection of equipment at the plant.

April 1, 2013

Concrete Structures – Preformed Joint Filler

Delete Subsection 702.2.2.1 of the Standard Specifications in its entirety and replace it with the following:

702.2.2.1 Preformed Joint Filler

Use preformed joint material that meets AASHTO M 153 or AASHTO M 213 with the following exceptions:

1. Use only materials manufactured from rubber.
2. Use materials that require a load of not less than 340 kPa or greater than 5200 kPa to compress to 50% of its thickness when tested in accordance with AASHTO T 42.
3. Use materials that have a recovery of at least 70% when tested in accordance with AASHTO T 42.

Use preformed joint material that is listed on QPL 81.

Provide a manufacturer's certification that states that the material conforms to SCDOT specifications.

May 5, 2014

PORTLAND CEMENT AND PORTLAND CEMENT CONCRETE

Subsection 701.2.1.1 Materials – Portland Cement - General, of the 2007 Standard Specifications is amended to add the use of Type IL Portland-limestone cement in addition to the materials given.

Add the following to Subsection 701.2.1.1 Materials – Portland Cement- General:

Type IL Portland-limestone cement may be used instead of Type I and Type II cement. If used, furnish Type IL cement conforming to the requirements of AASHTO M 240 and obtain from sources listed on the most recent edition of SCDOT Qualified Products 86. Provide an intimate and uniform blend of Portland cement and limestone. In any case, make certain that the limestone constituent is less than 15% of the total weight of the Portland-limestone cement.

Delete Subsection 701.4.9 – Construction – Fly Ash and Water-Granulated Blast-Furnace Slag - Items A and C of the 2007 Standard Specifications in their entirety and replace with the following:

- A. Fly ash or water-granulated blast furnace slag may replace allowable percentages of Type I, Type II, or Type III Portland cement or Type IL Portland-limestone cement. Do not use fly ash or slag replacement for mixes using Type I (SM) or Type IP blended cements.
- C. When fly ash is used to replace the Portland and Type IL Portland-limestone cement, replace at a ratio of not less than 1.2:1 by weight, and do not replace more than 20% of the cement originally called for in the mixture.

August 1, 2014

Class 5000 Structural Concrete

Subsection 701.2.12.2 Materials – Concrete Mix Design – Structural Concrete Table, of the 2007 Standard Specifications is amended to add Note 6 below to the Class 5000 Concrete shown in the Structural Concrete Table.

Note 6:

The maximum water to cementitious material ratio for Class 5000 concrete regardless of coarse aggregate type is 0.40 when air entrainment is required per 2007 Standard Specification Subsection 701.2.5 – Air Entrained Concrete.

February 1, 2015

CONCRETE ENTRAINED AIR AND SLUMP PROPERTIES

Insert the following into the Standard Specifications:

701.2.12.3.1 Entrained Air and Slump Tests

Prior to discharge into forms, entrained air content (as determined by ASTM C231 or ASTM C173) and slump (as determined by ASTM C143) tests will be performed by the Department's representative on the first concrete truck to arrive at the site for every pour to ensure specification compliance. If the first truck arrives with material that is out of tolerance, a retest will be performed after elected steps as outlined below have been taken to correct out of tolerance loads of concrete. Subsequent trucks will be tested, corrected as outlined below, and retested upon arrival until the material meets Department specifications. Once test results show consistently acceptable results, future entrained air and slump testing will be at the discretion of the Department's representative and when making concrete test specimens for compressive strength testing.

Secure the sample for testing after one cubic yard of concrete has been discharged from the delivery vehicle. The one cubic yard can be used in the work provided that it meets Department specifications and is placed into equipment such as a concrete bucket and crane that conveys the concrete without introducing contamination or segregation. The Department will then obtain at least two cubic feet of concrete from the delivery vehicle in a sampling receptacle that conforms to the requirements of ASTM C31.

If either the entrained air content or slump testing yields a test result that is outside of the allowable range, the Department's representative will perform one retest on a different sample of the load in question. Before the retest, the contractor and/or ready mixed concrete producer may elect to take steps to bring the mix within specifications such as adding additional air entraining admixture, adding water that was held back at the plant, etc. When taking these corrective steps, ensure that all other specifications such as allowable time, required number of additional mixing revolutions, and maximum water/cementitious material ratio are in compliance with Department specifications. If the results of the retest are still outside of the allowable range, the load will be rejected and the Contractor's representative will be immediately informed of the test results. Ensure that the producer is immediately notified of the test results through a pre-established means of communication. If the results of the retest indicate passing properties then the concrete will be permitted to be used in the work.

Ensure that no additional cement is added to loads of concrete previously rejected for excessive water content or slump, with the exception of Class 2500 non-structural concrete, as indicated in **Subsection 701.4.6**.

Acceptance or rejection will be based on the results obtained from these tests. Sampling, fabrication, and curing of cylinders to be used for compressive strength testing will be performed as required per ASTM Standards and the Standard Specifications.

August 3, 2015

SECTION 703 REINFORCING STEEL

Delete Subsections 703.2.4 and 703.2.5 in their entirety and replace them with the following:

703.2.4 Mechanical Couplers for Reinforcing Steel

703.2.4.1 General

Use mechanical coupler components that are compatible with the reinforcing bars specified in **Section 703** and manufacture all splices with the mechanical couplers as specified and detailed on the Plans. In selecting a coupler, consider the clearance requirements for correct installation and proper alignment of the reinforcing after installation. Use mechanical couplers from a manufacturer listed on the most recent edition of SCDOT Qualified Product List (QPL 73).

703.2.4.2 Quality Control Manager

Designate in writing, to the RCE, a Quality Control Manager (QCM) for all mechanical couplers. The QCM is responsible for the quality of the mechanical coupler splicing, including the inspection of materials and workmanship and for submitting correspondence, required submittals, and reports to the RCE. The QCM may be an employee of the Contractor.

703.2.4.3 Materials

703.2.4.3.1 General

A lot of mechanical couplers is defined as 150, or fraction thereof, of the same type of mechanical couplers used for each bar size and each bar deformation pattern that is used in the work. For ultimate mechanical couplers, the length of the coupler must be less than 10 times the nominal bar diameter. Use service couplers only in locations indicated on the design drawings. Ensure that mechanical couplers meet the following specifications:

- a. Cyclic and Fatigue tests when required (current version of Caltrans Test 670).
- b. Tensile test (ASTM A 370) - For ultimate mechanical couplers, a minimum tensile strength of 80 ksi or 125% of the actual yield strength of the reinforcing bar, whichever is greater. For service couplers, at least 125% of the specified minimum yield strength of the reinforcing bar.
- c. Slip test - according to the table listed in Section 52-6.02B of Caltrans Standard Specification.

703.2.4.3.2 Manufacturer's Certification

Provide to the RCE a certified statement from the manufacturer of each type of mechanical coupler used that includes the following information:

- a description of the device, including dimensions, designations, and material specifications
- a description of the method of packaging and identification
- a statement that the product meets **Section 703** of SCDOT specifications
- detailed installation instructions

703.2.4.4 Manufacturer's Quality Control Testing Facility and Reports

703.2.4.4.1 General

Ensure that all manufacturer quality control testing is performed in a laboratory that has been reviewed and accepted by the Structural Materials Engineer (SME) or has been accredited by AASHTO for all applicable tests. Ensure that the qualified laboratory used to perform the manufacturer's quality control testing of all splices meets and complies with the requirements of **Subsections 703.2.4.4.2 through 703.2.4.4.4.**

703.2.4.4.2 Facilities

Ensure that the qualified laboratory has a tensile testing machine capable of breaking the largest bar requiring testing in accordance with ASTM A 370 and applicable equipment needed for Caltrans Test 670.

703.2.4.4.3 Operators

Ensure that the machine operators have received formal training and are certified to perform the testing in conformance with ASTM A 370 and Caltrans Test 670.

703.2.4.4.4 Calibration

Ensure that the qualified laboratory has a record of annual calibration of testing equipment as outlined in AASHTO R-18, performed by an independent third party that has standards that are traceable to the National Institute of Standards and Technology (NIST) and has a formal reporting procedure, including published test reports.

703.2.4.4.5 Test Reports

Ensure that the following information is included in all test reports:

- Sampling procedures used,
- Test specimen preparation procedures if applicable,
- Test procedures used,
- Results of the tests listed in **Subsection 703.2.4.3.1**

703.2.4.5 Quality Control (QC) Test Requirements

For each lot of each bar size to be used, test two pre-job sample splices in conformance with these specifications and the requirements of ASTM A 370 in tension to ensure conformity with the requirements of Subsection 703.2.4.3.1. Upon completion of testing of each lot, provide the RCE with a written statement from the QCM stating that all couplers in this lot conform to the specifications.

703.2.4.6 Quality Assurance (QA) Sample Requirements

For each lot (as defined in **Subsection 703.2.4.3.1**) of each splice size, two complete samples of mechanical couplers with reinforcing bars of the same heat numbers that are being used in the work will be randomly obtained at the project site by the RCE and submitted to the OMR for

testing. Ensure that samples of complete reinforcing bars with coupler splice meet the requirements of **Subsection 703.2.5.4.2**. In the event one sample fails, submit two check samples of couplers from the same lot for testing.

703.2.4.7 Handling and Storage

Protect exposed threaded bars on staged work by installing the threaded coupler on the in-place bar and capping the open end of the coupler per the manufacturer's instructions. Immediately before installation, check the threads and ease of rotation of any threaded parts of couplers to detect contamination that could cause binding. Regardless of the method of mechanical coupling used, prevent damage to or contamination of the reinforcing or coupling devices that will inhibit or negatively affect the certified behavior of the device. If in the opinion of the RCE, such damage or contamination exists, replace the reinforcing, couplers, or both, or remove the contamination to the satisfaction of the RCE at no additional time or cost to the Department.

703.2.5 Ultimate Butt-Welded Splices (UBWS)

703.2.5.1 Material

Use UBWS containing steel that conforms to the requirements of **Subsection 703.2**.

703.2.5.2 Manufacturer's Quality Control Testing Facility

Ensure that all manufacturer quality control testing is performed in a laboratory that has been reviewed and accepted by the SME representative or has been accredited by AASHTO for all applicable tests. Ensure that the qualified laboratory used to perform the manufacturer's quality control testing of all splices meets and complies with the requirements of **Subsections 703.2.4.4.2 through 703.2.4.4.4**.

703.2.5.3 Fabricator Pre-job Test Requirements

Before incorporation into the work, ensure that Ultimate Butt Welded Splices are fabricated in conformance with the following pre-job test requirements:

- A. Notify the SME at least 14 calendar days before beginning production for the project so that a source visit can be arranged. The SME will make random visits to the fabricator during production.
- B. Obtain 4 pre-job sample splices for each bar size for UBWS that will be used in the work.
- C. Fabricate the sample splices using the same splice materials, position, operators, location, and equipment, and following the same procedures that will be used to make the splices in the work.
- D. Perform all fabricator pre-job testing in a laboratory that has been reviewed and accepted by the SME and meets the requirements of **Subsection 703.2.5.2**.
- E. Ensure that all UBWS from each pre-job test conform to the test criteria specified herein. Obtain a pre-job test report prepared by the laboratory performing the tests. Have the quality control manager, who represents the laboratory and accepts the responsibility for

the report's contents, sign the report. Ensure that the report contains, as a minimum, the following information for each sample:

- a. SCDOT Contract Number,
- b. SC Project ID,
- c. Bar size,
- d. Type of splice,
- e. Physical condition of test sample splice,
- f. Any notable defects,
- g. Limits of heat affected zone,
- h. Location of visible necking area,
- i. Ultimate strength of each splice.

F. Submit the pre-job test report to the SME for review and the RCE for acceptance.

703.2.5.4 Quality Assurance (QA) Test Requirements

703.2.5.4.1 General

A UBWS lot is defined as a shipment of the same type of UBWS used for each bar size and each heat number that is used in the work. Two test samples will be randomly selected by the RCE at the project site for each size and shipment of material for the work and submitted to the OMR for testing.

703.2.5.4.2 Test Sample Requirements

Each sample must meet the following requirements:

- A minimum of 30 inches in length with the splice located at mid-point,
- Accompanied by a Certified Mill Test Report for that bar's heat number, and
- Suitably identified before shipment with weatherproof markings.

Ensure that all sample test results are satisfactory before encasing any splices in concrete. If any splices are encased before receiving notification from the RCE, it is expressly understood that any material not conforming to these specifications will be subject to rejection, and the replacement of removed material will be at no expense to the Department and is not grounds for an extension of contract time.

703.2.5.4.3 Test Criteria

The Office of Materials and Research will test the tensile strength of the sample splice in conformance with the requirements of ASTM A 370 to ensure that the UBWS achieves at least 100 percent of the specified ultimate tensile strength of the reinforcing bar. Visible necking of the bar at rupture must occur outside of the heat affected zone which is defined as the region of the parent metal which has not been melted during welding and is typically measured to be one bar diameter from either side of the center of the weld. Brittle failure at points where leads have been connected will be cause of rejection.

In the event that one or both of the samples fail, submit two check samples from the same lot for testing by OMR. Any material not conforming to the requirements herein will be subject to

rejection. If the sample splice fails to conform to these provisions, all splices in the lot represented by the QA tests will be rejected.

Do not mix or combine the lots of UBWS being tested before the successful completion of the QA tests.

703.2.5.4.4 Corrective Action

Whenever a lot of UBWS is rejected, fulfill the following requirements before using additional UBWS in the work:

- A. Perform a complete review of the producer's quality control process for these splices.
- B. Submit a written report to the SME describing the cause of failure for the splices in this lot and provisions for correcting the failure in future lots.
- C. Ensure that the SME has provided the RCE notification that the report is acceptable. The SME will have at least 10 calendar days to review the report and notify the RCE of the report's status. The RCE will have at least 5 calendar days after notification to determine the course of action for the project.

If a QA test for any lot fails, replace all reinforcing bars representing failing sample splices before the RCE selects additional splices from the replacement for further testing.

When sampled bars are repaired with a pre-qualified Ultimate Mechanical Coupler as described in **Subsection 703.2.4**, QA tests are not required on the repaired splices.

*Add the following sentence to **Subsection 703.4.3**:*

Do not tack weld reinforcing bars.

July 1, 2018

Concrete Placement in Cold and Hot Weather

Delete Subsection 702.4.2.8.1 and 702.4.2.8.2 in their entirety and replace with the following:

702.4.2.8.1 Concreting in Cold Weather

Do not place concrete when the air temperature measured at the location of the concreting operation is below 35°F as determined by the RCE unless authorized by the RCE.

When concreting in cold weather above 35°F or with RCE authorization below 35°F, make available and implement measures utilizing suitable equipment and materials as necessary to protect the uncured concrete when air temperatures are anticipated to drop below 50°F at any time within 96 hours following concrete placement. Implemented measures shall maintain the air temperature surrounding the concrete between 50°F and 100°F. Place Hi-Lo thermometers on the concrete surface at locations directed by the RCE. Monitor concrete temperatures for a period of 4 days after the concrete is placed. Additional monitoring locations may be added by the contractor if deemed appropriate to ensure concrete protection.

Prior to placing concrete in cold weather, have a contingency plan and provisions in place to quickly and adequately address sudden temperature changes below those forecasted during the curing period. Check concrete temperatures before leaving for the day to determine if additional protection measures are needed when overnight temperatures are forecasted to drop below 35°F.

Implemented measures to protect concrete placed during cold weather may include but are not limited to the following:

- A. Curing blankets conforming to the requirements found in Subsection 702.3.4. If used, curing blankets are to remain in place for a minimum of 4 days.
- B. Heating equipment such as stoves, salamanders, or steam equipment deemed necessary to protect the concrete. Dry heat may be used provided a system to maintain adequate moisture is used to maintain the concrete in a wet condition during the curing period.
- C. Windbreaks or heated enclosures.

Before placing concrete, remove all ice and frost from all materials and surfaces in contact with the concrete.

Do not implement alternate measures to those listed above without prior approval by the RCE.

Recommendations provided in ACI 306R, Guide to Cold Weather Concreting may be used to meet the requirements of this subsection with RCE approval.

The contractor retains the responsibility for maintaining the temperature of the air surrounding the curing concrete within specified limits and for placing concrete that meets the requirements of the plan, specifications, and special provisions.

702.4.2.8.2 Concreting in Hot Weather

When concreting in hot weather, the contractor is required to implement measures to prevent a reduction in concrete workability, losses from cement hydration, evaporation, drying, or elevated concrete temperatures. Implement measures to maintain the temperature of concrete below 90°F when measured at the point of discharge from the delivery unit, with the exceptions of Class 2500 concrete and mass concrete pours. Cool steel forms and reinforcing steel exceeding 120°F prior to concrete placement.

Implemented measures to protect concrete placed during hot weather may include but are not limited to the following:

- A. Scheduling work so that the concrete can be placed with the least possible delay.
- B. Scheduling work so that the concrete can be placed during a cooler part of the day.
- C. Reducing loss of water through absorption by pre-wetting the sub-grade or forms just prior to concrete placement so that they will not absorb water from mix.
- D. Spraying forms and reinforcing steel with cool fresh water just before placement of concrete.
- E. Erecting windbreakers to prevent wind from drying exposed concrete surfaces while they are being finished.
- F. Using water-curing methods to provide evaporative cooling.
- G. Screed and float concrete as it is placed, and start curing procedures immediately.
- H. Applying liquid curing compound in accordance with Subsection 702.2.2.11 to all exposed surfaces as finishing is completed.

Do not allow the concrete temperature for Class 2500 concrete to exceed 95°F at discharge. Do not allow mass concrete mix temperature measured at discharge into the forms to exceed 80°F.

Do not implement alternate measures to those listed above without prior approval by the RCE.

Recommendations provided in ACI 305R, Guide to Hot Weather Concreting may be used to meet the requirements of this subsection with RCE approval.

The contractor retains the responsibility for placing concrete that meets the requirements of the plan, specifications, and special provisions.

APPROVED: JUNE 4 2018

SUPPLEMENTAL SPECIFICATION

By:

FEDERAL HIGHWAY ADMINISTRATION

July 1, 2018

Concrete Batching and Mixing in Cold and Hot Weather

Delete Subsections 701.4.4.2 and 701.4.4.3 in their entirety and replace them with the following:

701.4.4.2 Batching and Mixing in Cold Weather

When batching and mixing concrete at atmospheric temperatures below 50°F as determined by the RCE, ensure measures are implemented to provide batched concrete with a temperature of at least 50°F when placed in the forms. Batch and mix concrete at atmospheric temperatures below 35°F only when permitted by the RCE. Implemented measures may include but are not limited to the following:

- A. Replacing a portion of the design mix water with heated water not exceeding 170°F at discharge into the mixer.
- B. Heating aggregates by steam, dry heat, or placing in heated mixing water. Any aggregate heating method or apparatus used shall heat the aggregates uniformly without creating hot spots.

Aggregates that contain ice, frost, or frozen particles shall not be used in the concrete mix. When either aggregates or water are heated above 100°F, combine aggregate and a portion of the water prior to adding cement to avoid flash set. Cement may be added with water or with a mixture of water and aggregate having a temperature less than 100°F.

Do not implement alternate measures to those listed above without prior approval by the RCE.

Recommendations provided in ACI 306R, Guide to Cold Weather Concreting maybe used to meet the requirements of this subsection with RCE approval.

The contractor retains the responsibility for producing concrete that meets the requirements of the plans, specifications, and special provisions.

701.4.4.3 Batching and Mixing in Hot Weather

When batching and mixing concrete in hot weather, ensure measures are implemented to prevent the concrete mix temperature from exceeding 90°F measured before placement in the forms, unless specified otherwise. For Class 2500, do not allow the concrete mix temperature to exceed 95°F. For mass concrete pours, do not allow the concrete mix temperature to exceed 80°F as measured at discharge into the forms. This requirement does not apply to concrete used in precast/prestressed members.

Implemented measures to meet mix temperature requirements may include but are not limited to the following:

SUPPLEMENTAL SPECIFICATION

- A. Using Type II cement.
- B. Sprinkling coarse aggregate with water to cool by evaporation.
- C. Using chilled mixing water or cubed/crushed ice to replace part of the mixing water. If using ice, ensure the ice melts before batch is discharged from mixing unit.
- D. Scheduling pours during cooler portions of the day.

Do not implement alternate measures to those listed above without prior approval by the RCE.

Recommendations provided in ACI 305R, Guide to Hot Weather Concreting may be used to meet the requirements of this subsection with RCE approval.

The contractor retains the responsibility for producing concrete that meets the requirements of the plans, specifications, and special provisions.

SUPPLEMENTAL SPECIFICATION

January 1, 2019

**Concrete Structures –
Preformed Joint Filler**

Delete Subsection 702.2.2.1 of the Standard Specifications in its entirety and replace it with the following:

702.2.2.1 Preformed Joint Filler

Use either sponge rubber (Type I) or polyurethane-bonded recycled rubber (Type IV) preformed joint material that meets AASHTO M 153 specifications or Semi-Rigid, Closed-Cell Polypropylene Foam that meets ASTM D 8139 specifications. Other materials such as Polyvinyl Chloride (PVC) may be used, provided it meets recovery, compression and extrusion requirements as listed in either AASHTO M 153 or ASTM D 8139. Do not use non-extruding and resilient bituminous (AASHTO M 213) types of preformed joint filler.

Use only approved preformed joint material that is listed on QPL 81.

Provide a manufacturer's certification to the RCE that states that the material conforms to SCDOT specifications.

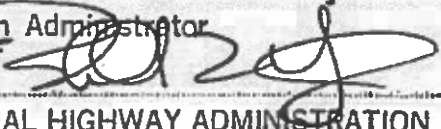
APPROVED: NOVEMBER 9, 2018
Division Administrator
By: 
FEDERAL HIGHWAY ADMINISTRATION

S.C. File No.

Page 1 of 1

July 1, 2019

APPROVED:

Division Administrator

By: _____
FEDERAL HIGHWAY ADMINISTRATION**Fine and Coarse Aggregate for Portland Cement Concrete**

Delete Subsection **701.2.9.1** of the Standard Specifications in its entirety and replace it with the following:

701.2.9.1 General

Submit the fine aggregate in the concrete mix design for approval to the OMR. Use natural sand, manufactured sand, or a combination of natural and manufactured sand meeting the requirements of **Subsection 701.2.9.1** through **701.2.9.8**. Use marine limestone fine aggregate only if the water soluble chloride content of the aggregate, when tested in accordance with ASTM C 1218, is less than 200 ppm.

Delete Subsection **701.2.10.1** of the Standard Specifications in its entirety and replace it with the following:

701.2.10.1 General

Use coarse aggregate that is clean, tough, durable crushed gravel or crushed stone. Make sure that it is free from soft, thin, elongated, or laminated pieces and sufficiently washed during production to produce a clean aggregate free from lumps or coatings of clay, disintegrated particles, vegetation, or deleterious substances. Adherent coatings are considered injurious. Do not use coarse aggregate with a Los Angeles Abrasion loss exceeding 60% as determined by AASHTO T 96. Use coarse aggregate that has a weighted loss not exceeding 15% when subjected to five alternations of the sodium sulfate soundness test determined by AASHTO T 104. Use coarse aggregate for Portland cement concrete conforming to the requirements in **Subsection 701.2.10.1** through **701.2.10.4**.

Use marine limestone coarse aggregate in reinforced concrete only if the water soluble chloride content of the aggregate, when tested in accordance with ASTM C 1218, is less than 200 ppm. For non-reinforced concrete applications, use marine limestone coarse aggregate that has a weighted loss not exceeding 25% when subjected to five alternations of the sodium sulfate soundness test conducted according to AASHTO T 104. When a marine limestone aggregate is used, use a sprinkler system to produce a saturated aggregate during concrete batching.

July 1, 2019

Delete Section **701.4.4.7 Mobile Concrete Mixing Plants** and replace it with the following:

701.4.4.7 Volumetric Concrete Mixers

Provide volumetric mixers with rating plates indicating that the performance of the mixer is in accordance with the Volumetric Mixer Manufacturer Bureau (VMMB). Ensure that mixers comply with ASTM C685. Unless otherwise specified, ensure that all mixing operations are in strict accordance with the manufacturer's recommended procedures. Provide such procedures to the RCE for review upon request.

Ensure that the concrete mixing truck is an auger-type continuous mixer used in conjunction with volumetric proportioning. Ensure that the mixer produces concrete, uniform in color and appearance, with homogeneous distribution of the material throughout the mixture. Establish the mixing time necessary to produce uniform concrete and comply with other requirements of these specifications. Only acceptable equipment capable of producing uniform results will be permitted.

Continuous volumetric concrete mixers may be used, with the approval of the RCE and State Materials Engineer, for non-structural concrete. Ensure that mix designs meet the requirements of Section 701.2.12.2 and all materials used meet the requirements of Section 701. Ensure that continuous volumetric concrete mixers are capable of combining aggregate, cement and/or fly ash, water and admixtures, into a uniform mixture within the specified mixing period. Ensure that all materials used are listed on the appropriate QPL (for example, fine aggregates, coarse aggregates, cement, fly ash, and admixtures).

Ensure that continuous volumetric concrete mixers meet the following additional requirements:

- A capacity to carry (in separate compartments for each ingredient) enough of each individual ingredient to produce a minimum of 6 cubic yards of concrete,
- A recording meter capable of measuring the cement as it is introduced into the mixture,
- An adjustable flow control valve capable of controlling the flow of water and admixture as they are introduced into the mixture,
- A water flow meter capable of indicating to the nearest 0.10 gallons, the quantity of gallons used,
- The capability of being calibrated to automatically proportion and blend all components of the concrete mixture on a continuous or intermittent basis, as required,
- Equipped with an onboard ticketing system that will electronically produce a record of all material used and their respective weights and total volume of concrete placed. Ensure that tickets also identify the following information at a minimum:
 - Contractor Name
 - SCDOT Project ID
 - Date
 - Truck No.

- Ticket No.
- Time start/end of pour
- Mix ID and description
- Aggregate moisture before mixing

Calibrate the continuous volumetric concrete mixer according to the manufacturer's recommendations. Provide the RCE with the means to verify the calibration of the continuous volumetric concrete mixer.

The RCE will allow operation of the continuous volumetric concrete mixer provided the concrete produced is within the limits of the specifications.

Tolerances in proportioning the various ingredients are as follows:

| | |
|------------------------------|---------|
| Cement, fly ash, mass % | 0 to +4 |
| Fine aggregate, mass % | ±2 |
| Coarse aggregate, mass % | ±2 |
| Admixtures, mass or volume % | ±3 |
| Water, mass or volume % | ±1 |

Perform the calibration process of each volumetric mixer at least once every 12 months or any time materials change.

Upon written request, the use of volumetric mixers may be allowed on small quantities of structural concrete on case by case basis upon approval by the RCE (or RME as applicable), DOC office and State Materials Engineer.

MEMORANDUM

TO: District Engineering Administrators
District Construction Engineers

FROM: Robert E. Isgett III, P.E. Director of Construction

DATE: April 20, 2020

RE: Temporary Revision to 2007 Standard Specification for Highway Construction, Section 701.4.4.1, Paragraph 2 – “Contactless” Weigh Ticket Protocol for COVID 19

In response to CDC guidelines related to COVID-19 and to ensure the safety of SCDOT, contractor, and consultant personnel, a “Contactless” Weigh Ticket Protocol has been created. This protocol is to be implemented immediately for all **Concrete Mixer Deliveries**. This temporary revision to Section 701.4.4.1 of the Standard Specifications will remain in effect until further notice.

Contactless Weigh Ticket Protocol

1. SCDOT will provide email for RCE (or designee) to the Contractor to then provide to the Concrete Producer.
2. Concrete Producer will provide truck driver with a copy of the batch ticket AND an *unsigned* copy of the 700.04 form (Class 3000 and above) to deliver on-site. Truck driver will securely post the batch ticket and 700.04 form at a location where both are fully visible to the inspector and contractor, while maintaining Social Distancing.
 - a. The batch ticket and 700.04 form will remain onsite. The inspector will not take possession of this paperwork. The contractor will dispose of these documents as job site trash once the inspector has gathered the needed information from it.
3. **For Class 3000 and above:** Inspector will gather information from the *unsigned* 700.04 form to populate the highlighted columns of the “700.04 Summary Log” (provided with this guidance). The remainder of the information on the 700.04 Summary Log will be completed on site following testing and placement of the concrete.
 - a. Proper care should be taken by Concrete Producers to ensure the accuracy of Plant Water Held on the 700.04 to ensure that Water / Cement Ratios will not be exceeded.
4. SCDOT Inspectors will sanitize their hands before AND after touching the water hose on the back of the concrete truck. Other disposable PPE may be used in place of sanitizer.



5. No later than 12:00 p.m. the next business day, the Concrete Producer will email, in PDF format (one form or ticket per page): 1) copies of all batch tickets and 2) copies of all *signed* 700.04 forms (if applicable).
 - a. The 700.04 Summary Log will be signed by the inspector and placed in the project file with the signed 700.04 forms from the Concrete Producer. The 700.04 Summary Log attached to the 700.04 forms (as received) will become the complete document and no additional notes on the 700.04 are required.

If you have any questions regarding this temporary revision, please contact Clay Richter at (803) 315-5330.

REI:cwr

ec: Randall Young, P.E., Chief Engineer for Project Delivery
Merritt Vann, Quality Program Manager
Merrill Zwanka, Materials & Research Engineer
Kevin Harrington, State Construction Engineer
Clay Richter, Road Construction Engineer
Tad Kitowicz, FHWA
Leslie Clark, Carolinas AGC

File:Con/cwr

July 1, 2020

APPROVED:

Division Administrator

THADDEUS

W KITOWICZ

By:

FEDERAL HIGHWAY ADMINISTRATION

Digitally signed by
THADDEUS W KITOWICZ
Date: 2020.05.28 16:15:25
-04'00'**REINFORCING STEEL**

The 2007 SCDOT Standard Specifications is amended as follows:

Delete every occurrence of "ASTM A 706" and replace with "AASHTO M 31, Type W."

Delete Subsection 703.2.1 in its entirety and replace it with the following:

703.2.1 Reinforcing Bars

Provide reinforcing bars (rebar) and dowels that meet the requirement of AASHTO M 31, Type W with a minimum single yield strength level of 60,000 psi, designated as Grade 60 and are from a source listed on the most recent edition of SCDOT Qualified Product List 60.

Each shipment of rebar delivered to the project must be accompanied by the manufacturer's mill test report for each heat included in the delivery. The mill test report must include the following:

- a. Producer information
- b. Heat number and size of rebar represented by the report
- c. The grade for which the steel qualifies
- d. Tensile test results including yield strength, tensile strength and elongation
- e. Statement ensuring that the steel was melted and manufactured in the United States

703.2.1.1 Quality Assurance (QA) Sample Requirements

Acceptance or rejection of all reinforcing steel, with the exception of those described in **Subsection 703.2.1.3**, is based on samples taken in the field by the SCDOT inspector or observed being taken in field by the SCDOT inspector and tested in conformance with the requirements of AASHTO T 244 by the OMR or an OMR authorized AASHTO accredited testing laboratory. Each sample must include one complete set of the bar's mill markings and must be accompanied by the sample heat's mill test report.

Once a rebar sample is obtained, the sample must remain in the custody of the SCDOT inspector until delivery to the OMR or OMR authorized AASHTO accredited testing laboratory. Samples delivered to the OMR by the contractor will not be accepted.

Any samples failing to meet the requirements of **Subsection 703.2.1** require two check samples of the same heat and rebar size. If either of the check samples fails, the heat represented is not to be used in the work and a sample must be taken from every size of every shipment of rebar produced by the same rebar producer for the remainder of the project.

703.2.1.2 Coiled Rebar

With the exception of Ultimate Butt-Welded Splices and bars included in **Subsection 703.2.1.3**, all rebar shipped in a coiled state from the producer listed on the most recent edition of SCDOT

Qualified Product List 60 must be sampled after mechanical straightening as used in the project. These samples must meet all specifications of AASHTO M 31, Type W as shipped to the project.

703.2.1.3 Reinforcing Bars Exempt from Acceptance Sampling and Testing

With the exception of Ultimate Butt-Welded Splices, reinforcing bars bent prior to shipment to the project that have no straight lengths 5-ft or longer will be accepted based upon a manufacturer's certified mill test report from a rebar producer listed on the most recent edition of Qualified Products List 60.

Delete Subsection 703.2.2 in its entirety and replace it with the following:

703.2.2 Wire and Wire Fabric

703.2.2.1 General

Provide wire and welded wire fabric for concrete reinforcement, either as such or in fabricated form conforming to the requirements of AASHTO M 336.

703.2.2.2 Wire (Non-welded) for Concrete Reinforcement

703.2.2.2.1 Quality Assurance (QA) Sample Requirements

Acceptance or rejection of wire (non-welded) for concrete reinforcement is based on samples taken in the field by the SCDOT inspector or observed being taken in field by the SCDOT inspector and tested in conformance with the requirements of AASHTO T 244 by the OMR or an OMR authorized AASHTO accredited testing laboratory. Each sample must be accompanied by the manufacturer's representative material certification and test report.

Once a wire sample is obtained, the sample must remain in the custody of the SCDOT inspector until delivery to the OMR or OMR authorized AASHTO accredited testing laboratory. Samples delivered to the OMR by the contractor will not be accepted.

Any samples failing to meet the requirements of **Subsection 703.2.1** require two check samples of the same shipment, producer and size. If either of the check samples fails, that size of wire from that producer from that shipment is rejected and not to be used in the work.

703.2.2.3 Welded Wire Fabric for Concrete Reinforcement

703.2.2.3.1 General

Any welded wire fabric provided for use on SCDOT projects must be produced by a manufacturer included on the most recent edition of QPL 85.

703.2.2.3.2 Acceptance Requirements

Acceptance of welded wire fabric for concrete reinforcement will be based upon the manufacturer's material certification and test report. The material certification and test report should indicate if the wires are deformed and the sizes of the wires in both directions. It should also contain the manufacturer's test results demonstrating that the welded wire meets the

requirements of AASHTO M 336 and the strength requirements shown in the plans. The report must also indicate that the steel was melted and manufactured in America.

Delete Subsections 703.2.4 and 703.2.5 in their entirety and replace them with the following:

703.2.4 Mechanical Couplers for Reinforcing Steel

703.2.4.1 General

Use mechanical coupler components that are compatible with the reinforcing bars specified in **Section 703** and manufacture all splices with the mechanical couplers as specified and detailed on the Plans. In selecting a coupler, consider the clearance requirements for correct installation and proper alignment of the reinforcing after installation. Use mechanical couplers listed on the most recent edition of SCDOT Qualified Product List 73 for the category of coupler required.

703.2.4.2 Materials

703.2.4.2.1 General

A LOT of mechanical couplers is defined as 150, or fraction thereof, of the same type of mechanical coupler used for each bar size and each bar deformation pattern that is used in the work. For ultimate mechanical couplers, the length of the coupler must be less than 10 times the nominal bar diameter. Use service couplers only in locations indicated on the design drawings. Ensure that mechanical couplers meet the following specifications when tested with AASHTO M 31, Type W rebar:

- a. Cyclic and Fatigue tests (current version of Caltrans Test 670)
- b. Tensile test (AASHTO T 244) – For ultimate mechanical couplers, a minimum tensile strength of 80 ksi, or 125% of the actual yield strength of the reinforcing bar, whichever is greater. For service couplers, at least 125% of the specified minimum yield strength of the reinforcing bar.
- c. Slip test – according to the table listed in Section 52-6.02B of the 2015 edition of Caltrans Standard Specifications.

703.2.4.2.2 Manufacturer's Certification

Provide to the RCE a certified statement from the manufacturer of each type of mechanical coupler used that includes the following information:

- a. A description of the device, including dimensions, designations, material specifications, and the specific model name.
- b. A description of the method of packaging and identification
- c. A statement that the product meets the requirements of **Section 703** of SCDOT specifications
- d. Detailed installation instructions

703.2.4.3 Quality Assurance (QA) Sample Requirements

Acceptance or rejection of mechanical couplers will be based upon random samples assembled by the contractor using reinforcing bars of the same heat numbers used in the work. Sample assemblies will be obtained at the project site by the RCE prior to being incorporated into the work and submitted to the OMR or OMR authorized AASHTO accredited testing laboratory for testing. If the sample fails, two check samples of coupler assemblies using couplers from the same LOT for testing are required.

If one or both of the check samples fail, the LOT of couplers is rejected and should not be used in the work.

When the lot of failing couplers is tapered and threaded bar type couplers, both the couplers and corresponding tapered and threaded rebar are rejected. If it is demonstrated to the satisfaction of the RCE that the tapering and threading on the rebar is correct, the rebar may be used with another lot of couplers, provided that a passing sample coupler assembly is obtained using the new lot of couplers. Alternatively, if it can be demonstrated to the satisfaction of the RCE that the rebar tapering and threading is incorrect and the couplers themselves are acceptable, the couplers may be used with another shipment of rebar, provided that a passing sample coupler assembly is obtained using the new shipment of tapered and threaded rebar.

Once a coupler assembly sample is obtained, the sample must remain in the custody of the SCDOT inspector until delivery to the OMR or OMR authorized AASHTO accredited testing laboratory. Samples delivered to the OMR by the contractor will not be accepted.

703.2.4.3.1 Test Criteria

The OMR will test the tensile strength of sample coupler assemblies in conformance with the requirements of AASHTO T 244 to ensure that the splice achieves an ultimate strength of at least:

- a. 75,000 psi for service splices
- b. 80,000 psi for ultimate splices

703.2.4.4 Handling and Storage

Protect exposed threaded bars on staged work by installing the threaded coupler on the in-place bar and capping the open end of the coupler per the manufacturer's instructions. Immediately before installation, check the threads and ease of rotation of any threaded parts of couplers to detect contamination that could cause binding. Regardless of the method of mechanical coupling used, prevent damage to or contamination of the reinforcing or coupling devices that will inhibit or negatively affect the certified behavior of the device. If in the opinion of the RCE, such damage or contamination exists, replace the reinforcing, couplers, or both, or remove the contamination to the satisfaction of the RCE at no additional time or cost to the Department.

703.2.5 Ultimate Butt-Welded Splices (UBWS)

703.2.5.1 Material

Use UBWS containing steel that conforms to the requirements of **Subsection 703.2.1**. Use only UBWS produced utilizing a resistance (flash) welding process by a fabricator listed on Qualified Product List 103 for the hoop diameter and bar size required.

703.2.5.2 Quality Assurance (QA) Test Requirements

703.2.5.2.1 General

A UBWS LOT is defined as a shipment of the same type of UBWS used for each bar size and each heat number that is used in the work. Acceptance or rejection will be based upon sample welded splices used in the work randomly selected by the RCE at the project site and submitted to the OMR or an OMR authorized AASHTO accredited laboratory for testing.

Once a UBWS sample is obtained, the sample must remain in the custody of the SCDOT inspector until delivery to the OMR or OMR authorized AASHTO accredited testing laboratory. Samples delivered to the OMR by the contractor will not be accepted.

Ensure that all sample test results are satisfactory before encasing any splices in concrete. If any splices are encased before receiving notification from the RCE, it is expressly understood that any material not conforming to these specifications will be subject to rejection, and the replacement of removed material shall be done at no additional time or cost to the Department.

703.2.5.2.2 Test Criteria

The OMR will test the tensile strength of the sample splice in conformance with the requirements of AASHTO T 244 to ensure that the UBWS achieves at least 100 percent of the specified ultimate tensile strength of the reinforcing bar.

If a sample fails, two check samples from the same LOT for testing by OMR are required. Any material not conforming to the requirements herein will be subject to rejection. If the sample splice fails to conform to these provisions, all splices in the LOT represented by the QA tests will be rejected.

Do not mix or combine the LOTS of UBWS being tested before the successful completion of the QA tests.

703.2.5.2.3 Corrective Action

Whenever a LOT of UBWS is rejected, fulfill the following requirements before using additional UBWS in the work:

- a. Perform a complete review of the producer's quality control process for these splices.
- b. Submit a written report to the SCDOT Structural Materials Engineer describing the cause of failure for the splices in this LOT and provisions for correcting the failure in future LOTS.
- c. Ensure that the Structural Materials Engineer has provided the RCE notification that the report is acceptable. The Structural Materials Engineer will have 15 business days to review the report and notify the RCE of the report's status. The RCE will have 10 business days after notification to determine the course of action for the project.

If a QA test for any LOT fails, replace all reinforcing bars representing failing sample splices before the RCE selects additional splices from the replacement for further testing.

When sampled bars are repaired with a pre-qualified Ultimate Mechanical Coupler as described in **Subsection 703.2.4**, QA tests are not required on the repaired splices.

Delete **Subsection 703.4.3; Paragraph 2** and replace it with the following:

- (2) Hold the reinforcement together by tie wire at all intersections except where the spacing is 12 inches or less in each direction, in which case tie alternate intersections. Hold bars projecting beyond a construction joint in place by templates during concreting to ensure proper position. Do not tack weld reinforcing bars.

January 1, 2021

Concrete Mix Design**APPROVED:**

Division Administrator

By: _____

FEDERAL HIGHWAY ADMINISTRATION

Subsection 701.2.12 of the SCDOT Standard Specifications is amended as follows:

Delete **Subsection 701.2.12.1** and replace with the following:

701.2.12.1 General

- 1 Design the concrete mix and determine the proportions of cementitious material, fine aggregate, coarse aggregate, and admixtures (when used) that produce a workable concrete mix. Meet the criteria for the typical classes of concrete shown in the Structural Concrete Table in **Subsection 701.2.12.2**. Consider the amount of air-entrainment that is incidentally afforded by the use of water-reducing or water-reducing/retarding admixtures. Determine the proportions of ingredients in accordance with requirements for the particular type of work and with consideration of the specific gravities of the materials to provide the desired workability and consistency.
- 2 At its own expense, the Contractor may retain an independent testing laboratory accredited by the AASHTO Accreditation Program to design the mix for the class of concrete specified, or use a mix design previously reviewed and used by the Department.
- 3 Submit all mix designs to the OMR for review a minimum of 12 business days prior to use in SCDOT projects. Submit the mixes on the appropriate OMR form approved by the SME. After successful review by the OMR, provide a copy of the mix design showing OMR's stamp to the RCE before supplying that mix to the project.
- 4 Once a mix has been reviewed by the OMR, that mix is valid for a period of three years provided that the mix ingredients or proportions are not changed. The mix may be supplied to any SCDOT project requiring that class of concrete during that period.
- 5 For the water-cementitious material ratio, use the ratio of water to cementitious materials by weight. When a mix design is reviewed by the OMR using a water-cementitious ratio lower than the maximum allowed in the Structural Concrete Table in **Subsection 701.2.12.2**, the lower water-cementitious ratio as reviewed by the OMR becomes the maximum allowable for that mix.
- 6 Design the concrete mix using Department qualified ingredients intended for use in the project and make any trial batches using such materials. Test trial mixes for complete conformance with the Specifications by the approved laboratory engaged by the Contractor.
- 7 Base mix designs on the air entrainment specifications in **Subsection 701.2.5**.
- 8 Base total water content of the mix on the weight of cement, fly ash, and silica fume multiplied by the water-cementitious ratio. Do not include the absorbed water in the aggregate as mix water.

- 9 Base mix designs on specific gravities and saturated surface dry moisture contents of coarse aggregate obtained from a source on the most recent edition of *SCDOT Qualified Product List 2* and fine aggregate obtained from a source on the most recent edition of *SCDOT Qualified Product List 1*. Include the SCDOT Number as shown on *SCDOT Qualified Product Lists 1 and 2* for all aggregate sources on the mix design form.
- 10 Base the Percent Fine to Coarse Aggregate Ratio on volume. Values of this ratio shown in the Structural Concrete Table in **Subsection 701.2.12.2** are general guidelines for the classes of concrete shown. Vary this ratio to obtain the desired workability.
- 11 No separate payment is made for the cost of the laboratory engaged by the Contractor, the materials furnished and used for trial batches, the preparation and testing of trial batches either by the Contractor or its laboratory, or furnishing the OMR with the mix data, the results of the cylinder tests, and yield to be tested. These costs are considered incidental to the work of the applicable item. Include the cost in the unit prices for the applicable pay items in the Contract.
- 12 After successful review of a mix design by the OMR, do not change the mix proportions or the sources of the individual mix ingredients with the exception of the fly ash source. Fly ash sources can be changed if needed due to supply issues (except for mass concrete mixes), provided that the alternate source is listed in *SCDOT Qualified Product List 3* and meets any other specification requirements. If modifications are necessary (other than the fly ash source), submit a new mix design for review by the OMR.

January 1, 2021

APPROVED:
Division Administrator

By: _____
FEDERAL HIGHWAY ADMINISTRATION

Section 702 Falsework/Forming Systems

Delete and replace Subsection 702.4.1.2 Design of the Standard Specifications in its entirety and replace with the following:

702.4.1.2 Design

- 1 Design falsework/form systems to handle all vertical and horizontal loading that may be placed upon it and with sufficient redundancy to prevent failure of the system because of the failure of any individual element. Include the sum of all anticipated vertical dead and live loads and real and assumed horizontal loads. Include the weight of the concrete, reinforcing steel and other encased items, equipment, personnel, forms, and falsework. For the weight of concrete, do not use less than 150 pounds per cubic foot for normal concrete and not less than 120 pounds per cubic foot for lightweight concrete.
- 2 For live loads, use the actual weight of any equipment and personnel to be supported by falsework applied as concentrated loads at the points of contact plus a uniform load of not less than 20 pounds per square foot applied over the area supported, plus 75 pounds per linear foot applied at the outside edge of deck overhangs.
- 3 For horizontal loads, use actual horizontal loads due to equipment and personnel, construction sequence, or other causes, plus an assumed horizontal wind load of not less than 50 pounds per square foot of horizontal surface area or 2% of the total dead and live load, whichever is greater.
- 4 Erect falsework with sufficient camber and/or adjustment to compensate for deflection and settlement under the weight of concrete so that the completed structure or part thereof has the alignment and curvature shown in the Plans. When footing type foundations are used for falsework support, determine the bearing value of the soil and show the values assumed in the design on the Working Drawings. Consider the effects of differential settlement. Limit settlement and support of falsework to 1 inch or less.
- 5 When falsework is to be placed adjacent to public roads, consider the effects of vibrations from passing vehicles and include provisions for protection of the falsework from errant vehicles.
- 6 If falsework from one bridge is to be used on another bridge, determine new loading conditions and verify the adequacy of the falsework system. Incorporate into the design any adjustments or changes necessary.
- 7 When the project Plans require the use of cofferdams and/or shoring systems for construction of bridge substructures or other elements of work, the Contractor is required to retain the services of an engineer(s) licensed pursuant to the laws of South Carolina who has (have) a minimum of 3 years of experience in the design of cofferdams and/or shoring systems. The Contractor is responsible for all structural and geotechnical design of the cofferdam or shoring system. Design all cofferdams or shoring systems using LRFD methods and in accordance with the following documents:
 - A. AASHTO Guide Design Specifications for Bridge Temporary Works, latest version with all interims
 - B. AASHTO Construction Handbook for Bridge Temporary Works, latest version with all interims

- C. AASHTO LRFD Bridge Construction Specifications, latest version with all interims
 - D. AASHTO LRFD Bridge Design Specifications, latest version with all interims
 - E. SCDOT Geotechnical Design Manual (GDM), latest version including all Geotechnical Design Bulletin (GDBs).
-
- 8 The load (γ) and resistance (ϕ) factors for temporary structures [service life (S_L) less than 5 years ($S_L < 5$ years)] contained in the SCDOT GDM shall be used in the design of the cofferdam or shoring system. Do not use Extreme Event I (EE I) in the design of cofferdams or temporary shoring systems, unless the cofferdam or permanent shoring system will be in use for 5 years or more. Prior to designing any cofferdam or permanent shoring system to be in service for 5 years or more, coordinate and discuss with the Regional Production Engineer, why the cofferdam or permanent shoring system must be in service 5 years or more.
 - 9 Design all cofferdams or shoring systems to resist all dead and live loadings including earth pressures, hydrostatic pressures, traffic loads, point loads, line loads, and surcharge loads that the cofferdam or shoring system may experience during the life of the structure (include on working drawings).
 - 10 The Contractor is solely responsible for the external and internal stability of all cofferdams or shoring systems. Use the soils information provided in the plans for these designs. If additional cofferdams or shoring systems are required by the Contractor's means and methods, the Contractor is solely responsible for obtaining the required geotechnical information. The Contractor's geotechnical exploration shall meet the requirements of the SCDOT GDM (latest version). All cofferdams or shoring systems are considered to be Earth Retaining Structures (ERSs).
 - 11 Submit the results of the geotechnical investigation; all design calculations, including soil design parameters used; methods of construction; details of components that will not be removed; and detailed drawings for design cases to RCE.
 - 12 When permanent embankments are to be constructed against the temporary shoring system, submit a method to prevent reflective cracking of the pavement structure at the top of the embankment that may occur at the interface between the two construction phases. This may be accomplished by constructing a load transfer platform beneath the pavement structure or approach slab that crosses over the two construction phases. Backfill any voids created by removal of the cofferdam or temporary shoring system.
 - 13 Provide all submittals in accordance with **Section 725**. Only submittals that have the seal and signature of the Contractor's Design (Structural and/or Geotechnical) Engineer-of-Record, who is licensed pursuant to the Laws of South Carolina, are acceptable.

July 1, 2021



Fine and Coarse Aggregate for Portland Cement Concrete and Prestressed Concrete

Delete **Subsection 701.2.9.1** of the Standard Specifications in its entirety and replace it with the following:

Section 701.2.9.1 General

Submit the fine aggregate in the concrete mix design for approval to the OMR. Use natural sand, manufactured sand, or a combination of natural and manufactured sand meeting the requirements of **Subsection 701.2.9.1** through **701.2.9.8**. Use marine limestone aggregate only if the water soluble chloride content of the aggregate, when tested in accordance with ASTM C1524, is below 200 ppm. Marine limestone coarse and fine aggregate can be used together only if their combined water soluble chloride content, when tested in accordance with ASTM C1524, is less than 200 ppm.

Delete **Subsection 701.2.10.1** of the Standard Specifications in its entirety and replace it with the following:

Section 701.2.10.1 General

Use coarse aggregate that is clean, tough, durable crushed gravel or crushed stone. Make sure that it is free from soft, thin, elongated, or laminated pieces and sufficiently washed during production to produce a clean aggregate free from lumps or coatings of clay, disintegrated particles, vegetation, or deleterious substances. Adherent coatings are considered injurious. Do not use coarse aggregate with a Los Angeles Abrasion loss exceeding 60% as determined by AASHTO T 96. Use coarse aggregate that has a weighted loss not exceeding 15% when subjected to five alternations of the sodium sulfate soundness test determined by AASHTO T 104. Use coarse aggregate for Portland cement concrete conforming to the requirements in **Subsection 701.2.10.1** through **701.2.10.4**.

Use marine limestone coarse aggregate in reinforced concrete only if the water soluble chloride content of the aggregate, when tested in accordance with ASTM C1524, is below 200 ppm. Marine limestone coarse and fine aggregate can be used together only if their combined water soluble chloride content, when tested in accordance with ASTM C1524, is less than 200 ppm. For non-reinforced concrete applications, use marine limestone coarse aggregate that has a weighted loss not exceeding 25% when subjected to five alternations of the sodium sulfate soundness test conducted in accordance with AASHTO T 104. When a marine limestone aggregate is used, use a sprinkler system to produce a saturated aggregate during concrete batching.

Delete **Subsection 704.2.1 (A)** of the Standard Specifications in its entirety and replace it with the following:

Section 704.2.1 (A)

Use marine limestone coarse aggregate and/or fine aggregate in prestressed concrete only if the total water soluble content of the combined coarse and fine aggregate, when tested in accordance with ASTM C1524, is below 100 ppm.

July 1, 2021

General

Delete Section 702.4.16 entirely and replace with the following:

APPROVED:**Division Administrator**THADDEUS
W KITOWICZDigitally signed by
THADDEUS W KITOWICZ
Date: 2021.05.11 12:11:29
-04'00'

By: _____

FEDERAL HIGHWAY ADMINISTRATION**702.4.16 Grooved Surface Finish**

- 1 After the new bridge deck concrete has cured and all applicable rideability specifications have been satisfied, cut grooves into the hardened concrete deck in conformance with this section. Groove the new bridge deck prior to opening the bridge to traffic. Groove any areas of bridge decks constructed in stages prior to opening the bridge to temporary or permanent traffic.
- 2 Cut the grooves into the hardened concrete using a mechanical sawing device that leaves grooves that are 0.125 inch wide and 0.125 inch deep. Provide grooves with a center-to-center spacing that vary randomly from 0.625 inch to 1.125 inches. Do not groove across expansion or contraction joints.
- 3 Skew angles discussed in this section are as measured from perpendicular to the centerline of the bridge. Groove the hardened surface of the bridge deck to the extents and in the directions as follows:
 - a. On bridges with skew angles less than or equal to 20 degrees, cut grooves parallel to the expansion or contraction joints. Extend grooving to within 2 to 4 inches from the edge of expansion or contraction joints and to between 6 and 18 inches from the gutterline or edge of the raised median. Triangular areas of ungrooved surface concrete are permitted within the 6 to 18 inches of transverse offset from the gutterline or edge of raised median.
 - b. On bridges with skew angles greater than 20 degrees or for irregular bridges with skews that vary, cut grooves perpendicular to the bridge centerline. Extend the grooving to between 2 and 18 inches from and perpendicular to the edge of expansion or contraction joints. Do not groove across expansion or contraction joints. Triangular areas of ungrooved surface concrete are permitted within the 2 to 18 inches of offset from expansion or contraction joints. Extend grooving to within 11 to 13 inches from the gutterline or edge of the raised median.
 - c. Cut grooves as directed in Paragraph A or B above for bridges constructed in stages whenever possible. If transverse grooving on a bridge constructed in stages would result in ungrooved pavements or an otherwise unsatisfactory groove pattern within the travel lanes, the Contractor may cut grooves parallel to the bridge centerline with written BCE approval. When grooving parallel to the bridge centerline, extend the groove pattern as directed in Paragraph B above.
- 5 Remove residue from the sawing operation from the deck by vacuum or other methods. Make certain all residue is legally disposed of off the construction site or uniformly distributed in the roadway embankment as directed by the RCE. Ensure that the residue does not remain on the deck nor is washed into the bridge drainage system.
- 6 Notify the RCE at least 3 calendar days before performing any deck grooving work. Any deviation from the above requirements shall be approved in writing by the RCE prior to starting work. Provide a written groove pattern to the RCE for approval utilizing Standard Form 700.21 before the work begins. Do not perform grooving without the presence of the RCE or a Department representative on site to view the grooving operation.

July 1, 2021

General**APPROVED:****Division Administrator****THADDEUS W KITOWICZ** Digitally signed by
THADDEUS W KITOWICZ
Date: 2021.05.12 11:55:21
-04'00'

By: _____

FEDERAL HIGHWAY ADMINISTRATION

Delete Subsection 702.4.5 of the Standard Specifications in its entirety and replace it with the following:

702.4.5 Removal of Falsework and Forms

- 1 In order to obtain a satisfactory surface finish, remove the forms for ornamental work, railings, parapets, and other vertical surfaces that will be exposed in the finished work as soon as the concrete has hardened sufficiently to allow the removal of the forms without damaging the edges, corners, and faces of the concrete. Do not remove the forms in less than 5 hours, nor more than 48 hours, unless the concrete is poured on Friday, in which case the forms may be removed the following Monday. Column and pier forms may be removed after 24 hours.
- 2 Keep forms and falsework under slabs, decks, beams, girders, caps, arches, and structures or parts of structures carrying static dead loads in place until the concrete compressive strength reaches at least 75% of the design strength. Compressive strength verification for the removal of forms and falsework on bent caps and full-depth patches on bridge decks may be performed through the use of a calibrated rebound hammer in conformance with SC-T-49. Other nondestructive test methods may be used where rebound hammer is allowed with prior approval by the BCE. For all other elements referenced above, make additional test cylinders and cure under similar conditions for use in form and falsework removal strength determinations. Document and report the results of all strength tests performed by the Contractor to the RCE prior to removing forms and falsework, regardless of the test method.
- 3 The allowance for the use of the calibrated rebound hammer described above is strictly for removal of forms and falsework. Strength requirements for the addition of superimposed load as described in Section 702.4.6 shall be verified with concrete test cylinders.
- 4 Do not use methods of form and falsework removal that are likely to cause overstressing of the concrete. In general, remove the forms from the bottom upward. Do not remove forms without the consent of the RCE.
- 5 Strike falsework supporting concrete beams, slabs, and brackets that will support sidewalks, concrete railing, or other applicable items before the sidewalk, concrete railing, or the other items are cast.
- 6 Extra test cylinders for early form or falsework removal will be at no additional expense to the Department.

July 1, 2021

APPROVED:

Division Administrator

THADDEUS
W KITOWICZ

Digitally signed by
THADDEUS W KITOWICZ
Date: 2021.05.11 14:35:08
-04'00'

By: _____

FEDERAL HIGHWAY ADMINISTRATION

High-Tensile-Strength Seven-Wire Strand

Subsection 704.2 of the SCDOT Standard Specifications is amended as follows:

Delete **Subsection 704.2.2.2** and replace with the following:

704.2.2.2 High-Tensile-Strength Seven-Wire Strand

- 1 Ensure high-tensile-strength seven-wire strand conforms to the requirements of AASHTO M 203. Use only high-tensile-strength seven-wire strand produced by sources included on the most recent edition of *SCDOT Qualified Product List 106*.

Delete **Subsection 704.2.4** and replace with the following:

704.2.4 Prestressing Steel, Post-Tensioning Strand and Anchorage Sampling and Testing

- 1 The Department reserves the right to sample and test prestressing steel, post-tensioning strands, and anchorage assemblies at any time when used on an SCDOT project.

January 1, 2022

General

APPROVED:

Division Administrator

THADDEUS Digitally signed by
W KITOWICZ THADDEUS W KITOWICZ
 Date: 2021.11.19 09:57:23
 -05'00'

By: _____
FEDERAL HIGHWAY ADMINISTRATION

Delete Subsection 702.4.2.5 of the Standard Specifications in its entirety and replace it with the following:

702.4.2.5 Mass Concrete Placement

Requirements for the use of mass concrete procedures are a function of equivalent cement content (ECC) of the concrete mix and the dimensions of the pour. ECC shall be determined on a per cubic yard basis with the following formula:

$$\text{ECC} = 1.0(\text{PC}) + 0.5(\text{FAF}) + 0.8(\text{FAC}) + 1.2(\text{SF}) + 1.0(\text{SC})$$

Where:

PC = portland cement, FAF = Class F fly ash, FAC = Class C fly ash, SF = silica fume, and SC = slag cement. All units are in pounds per cubic yard.

SCDOT requires the use of mass concrete procedures as outlined below:

- For concrete mixes with an ECC < 650 pounds per cubic yard, use procedures for mass concrete placement for a pour that has dimensions of 5 feet or greater in 3 different directions. In the case of a circular cross-section, a mass concrete placement is defined as a pour that has a diameter of 6 feet or greater and a length of 5 feet or greater.
- For concrete mixes with an ECC ≥ 650 pounds per cubic yard, use procedures for mass concrete placement for a pour that has dimensions of 4 feet or greater in 3 different directions. In the case of a circular cross-section, a mass concrete placement is defined as a pour that has a diameter of 5 feet or greater and a length of 4 feet or greater.
- Mass concrete requirements do not apply to Foundation Seals (Class 400S).

For all mass concrete pours, do not allow the maximum temperature during curing to exceed the temperatures listed below:

- For concrete mixes where the total cementitious materials consist of at least 25% Class F fly ash, 35% Class C fly ash, or 35% water granulated blast furnace slag by weight, the maximum temperature during curing shall not exceed 180°F.
- For all other concrete mixes, the maximum temperature during curing shall not exceed 160°F.

For all mass concrete pours, do not allow the mix temperature to exceed 80°F measured at discharge into the forms or shaft. With the exception of permanently cased drilled shafts, maintain a temperature differential of 35°F or less between the interior and exterior of all mass pour elements during curing. Temperature differential management is not required for drilled shafts that utilize construction casing in accordance with **Subsection 712.4.8.3**.

No later than 30 days before placing mass concrete, submit to the BCE for review and acceptance a *Mass Concrete Placement Plan* containing, but not limited to, the following:

- Concrete mix design to be used for the mass concrete pour,
- Analysis of the anticipated thermal developments within mass pour placements using the proposed materials and casting methods,

SUPPLEMENTAL SPECIFICATION

- *Temperature Control Plan* outlining specific measures to control the maximum temperature and differential within the limits noted above, and

- Details of the proposed monitoring system.

Submit for review by the OMR all special concrete mix designs, which are part of the *Temperature Control Plan*. Do not use High-early-strength (AASHTO M 85 Type III) cement or accelerating admixtures in mass concrete. As an additional measure to aid in temperature control of mass concrete elements, up to 35% of the minimum cement content may be replaced with fly ash.

Provide temperature monitoring devices to ensure the requirements of this specification are met. Temperature monitoring devices shall collect and record a minimum of one data point per hour. Redundancy shall be provided such that loss of a single monitoring device does not result in the inability to verify the requirements of this specification. Provide the RCE with a copy of each set of readings and a temperature chart for each mass pour element showing temperature readings vs. time. Temperature data shall be provided to the RCE on a daily basis through the conclusion of monitoring. The RCE, at their discretion, may suspend subsequent mass concrete placements for failure to comply with the reporting requirements herein.

An exclusion to the temperature monitoring requirements will be permitted for drilled shafts meeting all of the following conditions:

1. Shaft diameter less than 10 feet (thickness of casing, if present, may be excluded from measurement),
2. Total cementitious materials within concrete mix consists of at least 25% Class F fly ash by weight,
3. ECC of concrete mix is less than or equal to 575 pounds per cubic yard, and
4. Placement temperature of 80 °F or less.
5. Use of construction casing in accordance with **Subsection 712.4.8.3**.

For drilled shafts not meeting all of the conditions outlined above, place temperature monitoring devices on 10-foot maximum intervals from the mid-depth to the top of the shaft. Monitors should not be placed within one shaft diameter from the top of the shaft. For shafts less than 40 feet in length, a minimum of 2 elevations shall be monitored. For uncooled shafts, monitoring locations should be centrally located. Minor offsets may be permitted to allow for tremie access if permitted by the BCE. Where cooling tubes are utilized, monitoring locations shall be laterally placed at the estimated center of heat generation. Coordinate the placement of temperature monitoring devices with shaft reinforcing and CSL access tubes provided in accordance with Section 727 of the Standard Specifications. Do not provide additional access tubes around the perimeter of the reinforcing cage that will reduce reinforcing clearances. Do not use monitoring equipment cast into shafts that will interfere with CSL testing. Continue monitoring temperatures in drilled shafts for a minimum of 36 hours after the maximum temperature is measured.

For all other mass concrete placements, record temperature development between the location of maximum heat and exterior of the element at points accepted by the BCE and closely monitor the mass pour maximum temperature and temperature differential. Generally, use one monitoring point in the center of the largest mass of concrete and a second point approximately 2 inches inside the face nearest to the first monitoring point. Continue monitoring temperature until the interior temperature is within 35°F of the lowest ambient temperature or a maximum of two weeks.

If the monitoring indicates that the proposed measures are not controlling the concrete temperatures as specified herein, provide to the BCE an engineering assessment of the short and long-term impacts associated with the non-conformance. All costs associated with inspection, testing, and evaluation of the non-conformance are the sole responsibility of the Contractor. Additionally, make the necessary revisions to the *Temperature Control Plan* and submit the revised plan for review. No additional mass concrete placements will be allowed until the required items have been provided and accepted by the BCE.

SUPPLEMENTAL SPECIFICATION

The Contractor assumes all risks connected with placing a mass pour of concrete. BCE review of the Contractor's *Mass Concrete Placement Plan* will in no way relieve the Contractor of the responsibility for obtaining satisfactory results. Should any mass concrete placed under this specification prove unsatisfactory in the judgement of the Department, make the necessary repairs or remove and replace the material at no expense to the Department.

Provide the control of temperatures in mass concrete pours in addition to any other requirements found on the Plans and/or in the Special Provisions that apply to the work in question. Include all costs associated with temperature controls for mass concrete placement in the unit cost of the concrete.

January 1, 2022

General

APPROVED:

Division Administrator

THADDEUS
W KITOWICZDigitally signed by
THADDEUS W KITOWICZ
Date: 2021.11.19 09:57:23
-05'00'

By: _____

FEDERAL HIGHWAY ADMINISTRATION

Delete Subsection 702.4.2.5 of the Standard Specifications in its entirety and replace it with the following:

702.4.2.5 Mass Concrete Placement

Requirements for the use of mass concrete procedures are a function of equivalent cement content (ECC) of the concrete mix and the dimensions of the pour. ECC shall be determined on a per cubic yard basis with the following formula:

$$\text{ECC} = 1.0(\text{PC}) + 0.5(\text{FAF}) + 0.8(\text{FAC}) + 1.2(\text{SF}) + 1.0(\text{SC})$$

Where:

PC = portland cement, FAF = Class F fly ash, FAC = Class C fly ash, SF = silica fume, and SC = slag cement. All units are in pounds per cubic yard.

SCDOT requires the use of mass concrete procedures as outlined below:

- For concrete mixes with an ECC < 650 pounds per cubic yard, use procedures for mass concrete placement for a pour that has dimensions of 5 feet or greater in 3 different directions. In the case of a circular cross-section, a mass concrete placement is defined as a pour that has a diameter of 6 feet or greater and a length of 5 feet or greater.
- For concrete mixes with an ECC ≥ 650 pounds per cubic yard, use procedures for mass concrete placement for a pour that has dimensions of 4 feet or greater in 3 different directions. In the case of a circular cross-section, a mass concrete placement is defined as a pour that has a diameter of 5 feet or greater and a length of 4 feet or greater.
- Mass concrete requirements do not apply to Foundation Seals (Class 4000S).

For all mass concrete pours, do not allow the maximum temperature during curing to exceed the temperatures listed below:

- For concrete mixes where the total cementitious materials consist of at least 25% Class F fly ash, 35% Class C fly ash, or 35% water granulated blast furnace slag by weight, the maximum temperature during curing shall not exceed 180°F.
- For all other concrete mixes, the maximum temperature during curing shall not exceed 160°F.

For all mass concrete pours, do not allow the mix temperature to exceed 80°F measured at discharge into the forms or shaft. With the exception of permanently cased drilled shafts, maintain a temperature differential of 35°F or less between the interior and exterior of all mass pour elements during curing. Temperature differential management is not required for drilled shafts that utilize construction casing in accordance with **Subsection 712.4.8.3**.

No later than 30 days before placing mass concrete, submit to the BCE for review and acceptance a *Mass Concrete Placement Plan* containing, but not limited to, the following:

- Concrete mix design to be used for the mass concrete pour,
- Analysis of the anticipated thermal developments within mass pour placements using the proposed materials and casting methods,

SUPPLEMENTAL SPECIFICATION

- *Temperature Control Plan* outlining specific measures to control the maximum temperature and differential within the limits noted above, and

- Details of the proposed monitoring system.

Submit for review by the OMR all special concrete mix designs, which are part of the *Temperature Control Plan*. Do not use High-early-strength (AASHTO M 85 Type III) cement or accelerating admixtures in mass concrete. As an additional measure to aid in temperature control of mass concrete elements, up to 35% of the minimum cement content may be replaced with fly ash.

Provide temperature monitoring devices to ensure the requirements of this specification are met. Temperature monitoring devices shall collect and record a minimum of one data point per hour. Redundancy shall be provided such that loss of a single monitoring device does not result in the inability to verify the requirements of this specification. Provide the RCE with a copy of each set of readings and a temperature chart for each mass pour element showing temperature readings vs. time. Temperature data shall be provided to the RCE on a daily basis through the conclusion of monitoring. The RCE, at their discretion, may suspend subsequent mass concrete placements for failure to comply with the reporting requirements herein.

An exclusion to the temperature monitoring requirements will be permitted for drilled shafts meeting all of the following conditions:

1. Shaft diameter less than 10 feet (thickness of casing, if present, may be excluded from measurement),
2. Total cementitious materials within concrete mix consists of at least 25% Class F fly ash by weight,
3. ECC of concrete mix is less than or equal to 575 pounds per cubic yard, and
4. Placement temperature of 80 °F or less.
5. Use of construction casing in accordance with **Subsection 712.4.8.3**.

For drilled shafts not meeting all of the conditions outlined above, place temperature monitoring devices on 10-foot maximum intervals from the mid-depth to the top of the shaft. Monitors should not be placed within one shaft diameter from the top of the shaft. For shafts less than 40 feet in length, a minimum of 2 elevations shall be monitored. For uncooled shafts, monitoring locations should be centrally located. Minor offsets may be permitted to allow for tremie access if permitted by the BCE. Where cooling tubes are utilized, monitoring locations shall be laterally placed at the estimated center of heat generation. Coordinate the placement of temperature monitoring devices with shaft reinforcing and CSL access tubes provided in accordance with Section 727 of the Standard Specifications. Do not provide additional access tubes around the perimeter of the reinforcing cage that will reduce reinforcing clearances. Do not use monitoring equipment cast into shafts that will interfere with CSL testing. Continue monitoring temperatures in drilled shafts for a minimum of 36 hours after the maximum temperature is measured.

For all other mass concrete placements, record temperature development between the location of maximum heat and exterior of the element at points accepted by the BCE and closely monitor the mass pour maximum temperature and temperature differential. Generally, use one monitoring point in the center of the largest mass of concrete and a second point approximately 2 inches inside the face nearest to the first monitoring point. Continue monitoring temperature until the interior temperature is within 35°F of the lowest ambient temperature or a maximum of two weeks.

If the monitoring indicates that the proposed measures are not controlling the concrete temperatures as specified herein, provide to the BCE an engineering assessment of the short and long-term impacts associated with the non-conformance. All costs associated with inspection, testing, and evaluation of the non-conformance are the sole responsibility of the Contractor. Additionally, make the necessary revisions to the *Temperature Control Plan* and submit the revised plan for review. No additional mass concrete placements will be allowed until the required items have been provided and accepted by the BCE.

SUPPLEMENTAL SPECIFICATION

The Contractor assumes all risks connected with placing a mass pour of concrete. BCE review of the Contractor's *Mass Concrete Placement Plan* will in no way relieve the Contractor of the responsibility for obtaining satisfactory results. Should any mass concrete placed under this specification prove unsatisfactory in the judgement of the Department, make the necessary repairs or remove and replace the material at no expense to the Department.

Provide the control of temperatures in mass concrete pours in addition to any other requirements found on the Plans and/or in the Special Provisions that apply to the work in question. Include all costs associated with temperature controls for mass concrete placement in the unit cost of the concrete.

Chapter 6

Moisture Correction and Concrete Batching

This chapter will contain:

Class Presentations

And step-by-step instruction regarding:

6.1 Moisture Correction for Fine and Course Aggregate using the Dry Method

6.2 Concrete Batching

Minimum Cement Content
Additional Cementitious Material Content
Maximum Water to Cementitious Material (w/c) Ratio
Fine to Course Aggregate Ratio

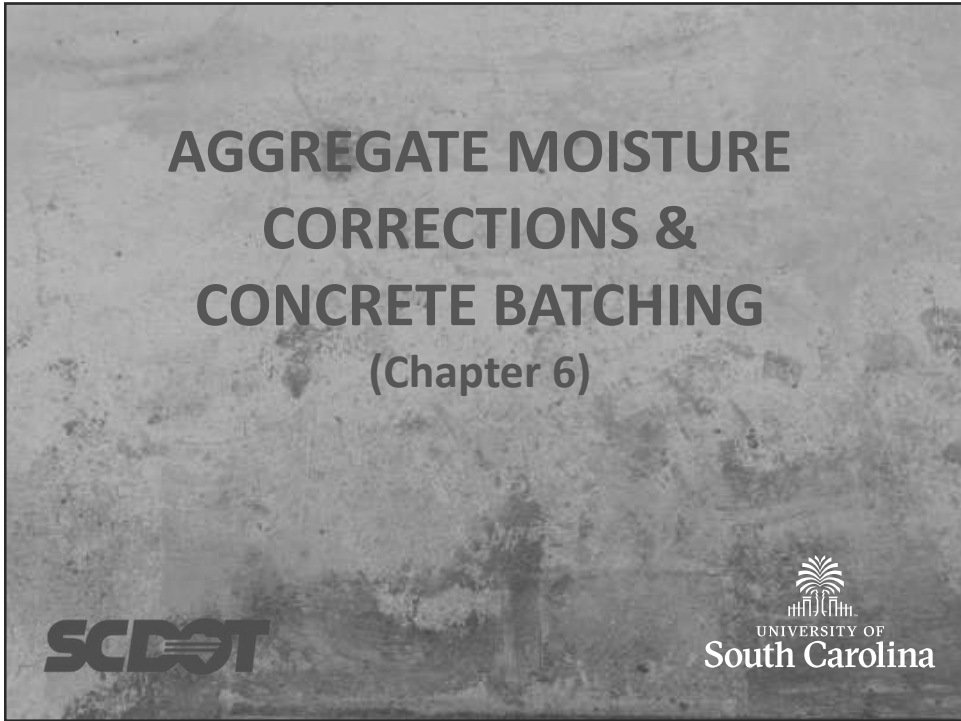

AGGREGATE MOISTURE CORRECTION

- The moisture content in aggregates must be considered when batching concretes to assure consistency and to control total water content in the concrete mixture
- Not taking into account the free moisture on the aggregates can lead to exceeding specified water to cement ratios
- It can lessen the durability of the concrete structure, as well as lower the compressive and flexural strengths.



ASTM C 566 or AASHTO T 255 *Standard Test Method for Total Evaporable Moisture Content by Drying* gives guidance in the proper way to determine the moisture content to aggregates.



SSD MOISTURE CONTENT OF THE AGGREGATE IS:

$$S = \left[\left(\frac{W - D}{D} \right) * 100 \right] - A$$

WHERE:

S = Total moisture content of sample at SSD in percent

W = Mass of original sample in grams

D = Mass of dried sample in grams

A = Absorption of the aggregate in percent



EXAMPLE

You are given a moist sample of fine aggregate in a pan where the combined weight of the pan and the fine aggregate sample weighs 215 grams. The fine aggregate came from **B. V. HEDRICK GRAVEL & SAND** from **LILESVILLE, NC** (Lilesville Mine) and you are instructed to get the moisture content for the saturated surface dry material in order to make concrete mix design corrections for the moisture content of a SCDOT Class 4000 concrete. The pan that you are using to dry the material weighs 100 grams. After the material has finished drying, the fine aggregate that you dried and the pan used to dry the material has a combined weight of 209 grams.

What is SSD moisture content of the fine aggregate?



STEP 1. Determine the weight of the fine aggregate before and after drying.

Weight of the Fine Aggregate prior to Drying:

$$W = 215\text{g} - 100\text{g}$$

$$W = 115\text{g}$$

Weight of Fine Aggregate after Drying:

$$D = 209\text{g} - 100\text{g}$$

$$D = 109\text{g}$$



STEP 2. Determine the Absorption of the Aggregate.

- Go to the SCDOT QPL for Fine Aggregate and look up the B. V. HEDRICK GRAVEL & SAND from LILESVILLE, NC (Lilesville Mine) and find the absorption for that aggregate.
- Qualified Products List 1 Page 1 has the absorption for B. V. HEDRICK GRAVEL & SAND from LILESVILLE, NC (Lilesville Mine) as 0.8 percent.



STEP 3. Substitute values from Step 1 and Step 2 into equation and solve for S

$$S = \left[\left(\frac{W - D}{D} \right) * 100 \right] - A$$

$$S = \left[\left(\frac{115 - 109}{109} \right) * 100 \right] - 0.8$$

$$S = 4.7\%$$





If the moisture adjustment was not used in a concrete mix that contained 1100 pounds of fine aggregate per cubic yard, there would be 51.7 pounds or 6.2 gallons of additional water added to the concrete mix and the water to cement ratio would most probably be exceeded.



MIX PROPORTION DEVELOPMENT

The proportioning of a concrete mix design should result in an economical and practical combination of materials to produce concrete with the properties desired for its intended use, such as workability, strength, durability and appearance.



1955

STRUCTURAL CONCRETE

| Class of Concrete | Bag of Cement For Cubic Yard of Concrete | Designed Strength at 28 Days psi | GRAVEL-COARSE AGGREGATE | | | | | CRUSHED STONE-COARSE AGGREGATE | | | | |
|-------------------|--|----------------------------------|-------------------------|--------------------------|----------------------------|---------------|----------------|--------------------------------|--------------------------|----------------------------|---------------|----------------|
| | | | Pounds of Cement | Pounds of Fine Aggregate | Pounds of Coarse Aggregate | Water Gallons | Yield Cu. Yds. | Pounds of Cement | Pounds of Fine Aggregate | Pounds of Coarse Aggregate | Water Gallons | Yield Cu. Yds. |
| AA | 7½ | 3500 | 94* | 155* | 302* | 4.30* | 1.39* | 94* | 155* | 304* | 4.50* | 1.33* |
| A | 6½ | 3000 | 94* | 150* | 340* | 4.90* | 1.60* | 94* | 160* | 334* | 5.00* | 1.60* |
| B | 5½ | 2500 | 94 | 190 | 440 | 6.25 | 1.90 | 94 | 210 | 410 | 8.55 | 1.90 |
| C | 4½ | 2000 | 94 | 250 | 545 | 8.00 | 2.35 | 94 | 275 | 505 | 8.70 | 2.35 |
| A | 3½ | 3000 | 94 | 155 | 355 | 5.60 | 1.60 | 94 | 160 | 350 | 5.70 | 1.60 |

* Based on 4½ percent air.
 Weights based on a bulk specific gravity (saturated surface-dry basis) of aggregates of 2.65. If aggregates which have specific gravities other than 2.65 are used, proportionate adjustments shall be made in the above weights so as to secure equivalent volumes.
 The above quantities are based on the aggregates being saturated surface-dry, which is to say that internal voids in each piece of aggregate are filled with water but the surface area of each piece of aggregate is dry.

X 7 1/2 5000 4 130 275 500



2007

701.2.12.2 Structural Concrete Table

Unless otherwise noted or directed, make certain that the properties of the various classes of concrete incorporated into the work conform to the following Structural Concrete Table. Compressive strength is based on ASTM C 39.

| Structural Concrete Table | | | | | |
|------------------------------------|----------------------------------|---------------------------------------|------------------------------|--|---|
| Aggregate Type | Minimum Cement Content (lbs./CY) | Other Cementitious Material (lbs./CY) | Min. 28 Day Mix Design (psi) | Percent Fine to Coarse Aggregate Ratio | Max. Water to Cementitious Material Ratio |
| Class 2500 (Non Structural) | | | | | |
| Crushed stone | 494 | -- | 2500 | 36.64 | 0.54 |
| Gravel | 494 | -- | 2500 | 35.65 | 0.52 |
| Marine Limestone | 494 | -- | 2500 | 40.60 | 0.56 |

(table continued on the next page)



(table continued from the previous page)

| Structural Concrete Table | | | | | |
|---|----------------------------------|---------------------------------------|------------------------------|--|---|
| Aggregate Type | Minimum Cement Content (lbs./CY) | Other Cementitious Material (lbs./CY) | Min. 28 Day Mix Design (psi) | Percent Fine to Coarse Aggregate Ratio | Max. Water to Cementitious Material Ratio |
| Class 3000 | | | | | |
| Crushed stone | 588 | -- | 3000 | 35:65 | 0.46 |
| Gravel | 588 | -- | 3000 | 34:66 | 0.44 |
| Marine Limestone | 588 | -- | 3000 | 39:61 | 0.47 |
| Class 4000 | | | | | |
| Crushed stone | 611 | -- | 4000 | 35:65 | 0.40 |
| Gravel | 611 | -- | 4000 | 34:66 | 0.40 |
| Class 4000S | | | | | |
| Crushed stone | 682 | -- | 4000 | 38:62 | 0.45 |
| Gravel | 682 | -- | 4000 | 38:62 | 0.45 |
| Class 4000DS (See Notes 2 & 4) | | | | | |
| Crushed stone | 625 | -- | 4000 | 40:60 | 0.44 |
| Gravel | 625 | -- | 4000 | 39:61 | 0.43 |
| Class 4000P (See Note 5) | | | | | |
| Crushed stone | 682 | -- | 4000 | 34:66 | 0.43 |
| Gravel | 682 | -- | 4000 | 33:67 | 0.38 |
| Class 5000 | | | | | |
| Crushed stone | 705 | -- | 5000 | 35:65 | 0.46 |
| Gravel | 705 | -- | 5000 | 34:66 | 0.42 |

(table continued on the next page)



(table continued from the previous page)

| Structural Concrete Table | | | | | |
|---|----------------------------------|--|------------------------------|--|---|
| Aggregate Type | Minimum Cement Content (lbs./CY) | Other Cementitious Material (lbs./CY) | Min. 28 Day Mix Design (psi) | Percent Fine to Coarse Aggregate Ratio | Max. Water to Cementitious Material Ratio |
| Class 6000 | | | | | |
| Crushed stone | 750 | -- | 6000 | 34:66 | 0.44 |
| Gravel | 750 | -- | 6000 | 33:67 | 0.39 |
| Class 6500 (See Notes 1 & 3) | | | | | |
| Crushed stone | 500 | CF35, FA140 | 4000 | 37:63 | 0.37 |
| Gravel | 500 | CF35, FA140 | 4000 | 38:62 | 0.37 |
| Class 7000 | | | | | |
| Crushed stone | 800 | -- | 7000 | 35:65 | 0.37 |
| Gravel | 800 | -- | 7000 | 34:66 | 0.37 |
| Class 8000 | | | | | |
| Crushed Stone | 840 | -- | 8000 | 34:66 | 0.30 |
| Gravel | 840 | -- | 8000 | 34:66 | 0.30 |
| Class 10000 | | | | | |
| Crushed stone, or Gravel | 800 | Silica Fume: 74 & Fly Ash, Type F: 100 | 10000 | 34:66 | 0.25 |



Develop the Mix Proportions for a Class 4000 PCC using SCDOT Guidelines.

Class 4000 Concrete.

Design the Mix such that 20% of the cement is replaced with fly Ash.

| | | | |
|------------------|--------|------------------------------|---------------------|
| Coarse Aggregate | Gravel | Specific Gravity (SG) = 2.70 | 1% Moisture Content |
| Fine Aggregate | Sand | Specific Gravity (SG) = 2.68 | 4% Moisture Content |

Determine the required weight of each component to batch a total of 6 cubic yards.

Cement _____
 Fly Ash _____
 Silica Fume _____
 Added Water _____
 Fine Aggregate _____
 Coarse Aggregate _____

How many gallons of **Added Water** were required? _____

| CONCRETE BATCHING PER CUBIC YARD | | | | cu. yd batch weight |
|--|--|--------------------|--------------------|------------------------|
| Cement: | _____ lbs = _____ ft ³ | | | _____ lbs |
| | <small>3.15 x 62.4</small> | | | |
| Fly Ash | _____ lbs = _____ ft ³ | | | _____ lbs |
| | <small>2.25 x 62.4</small> | | | |
| Silica Fume | _____ lbs = _____ ft ³ | | | _____ lbs |
| | <small>2.20 x 62.4</small> | | | |
| Other | _____ lbs = _____ ft ³ | | | _____ lbs |
| | <small>_____ x 62.4</small> | | | |
| Added Water: | _____ lbs = _____ ft ³ | | | _____ lbs |
| | <small>1 x 62.4</small> | | | |
| Air: | 27 x _____ % = _____ ft ³ | | | |
| Volume of Paste | _____ ft ³ (A) | | | |
| Volume of Aggregate: 27 - (A) | _____ ft ³ (B) | | | |
| (B) x Aggregate Ratio = Volume of Each Aggregate | | | | |
| Fine Aggregate | _____ x _____ = _____ ft ³ x _____ x 62.4 _____ lbs | | | |
| | <small>(B)</small> | <small>%FA</small> | <small>(C)</small> | <small>SG</small> |
| Coarse Aggregate | _____ x _____ = _____ ft ³ x _____ x 62.4 _____ lbs | | | |
| | <small>(B)</small> | <small>%CA</small> | <small>(D)</small> | <small>SG</small> |
| Check Volume: (A+C+D must = 27 ft ³) | _____ ft ³ | | | |
| Total Weight per cu. yd. | _____ lbs/cu. yd. | | | |

Standard Specifications 701.20.C

| STRUCTURAL CONCRETE TABLE | | | | | |
|---------------------------|---------------------------------|--------------------------------------|------------------------------|--|----------------------------|
| Aggregate Type | Minimum Cement Content (lbs/CY) | Other Cementitious Material (lbs/CY) | Min. 28 Day Mix Design (psi) | Percent Fine to Coarse Aggregate Ratio | Max. Water to Cement Ratio |
| Class 4000 (see note 4) | | | | | |
| Crushed Stone | 611 | -- | 4000 | 35:65 | 0.40 |
| Gravel | 611 | -- | 4000 | 34:66 | 0.40 |



STEP 1-3. Read the instructions carefully and refer to the step by step guide.

STEP 4A. Per the Structural Concrete Table located in the SCDOT Construction Manual, Section 701.20, a Class 4000 PCC made with gravel requires a minimum cement content of 611 lbs. per cubic yard. Since this mix calls for a 20% fly ash replacement, the necessary weight of cement will be 20% less than 611 lbs.

$$611 - (611 \times 20\%) = 488.8 = \underline{489 \text{ lbs}}$$

STEP 4B. Convert 489 lbs to a volume expressed in cubic feet by dividing the weight by the product of 3.15 x 62.4. Carry the answer for three decimal places.

*round to three decimal places for **Volumes**

| |
|---|
| Cement: $\frac{489}{3.15 \times 62.4} \text{ lbs} = \underline{2.488 \text{ ft}^3}$ Yd ³ batch Weight <u>489</u> |
|---|



| CONCRETE BATCHING PER CUBIC YARD | | | |
|--|-----------------------------|------------------------------------|-------------------------------|
| | | | cu. yd batch weight lbs |
| Cement: | <u>489</u> | lbs = <u>2.488</u> ft ³ | <u>489</u> lbs |
| | <small>3.15 x 62.4</small> | | |
| Fly Ash | _____ | lbs = _____ ft ³ | _____ lbs |
| | <small>2.25 x 62.4</small> | | |
| Silica Fume | _____ | lbs = _____ ft ³ | _____ lbs |
| | <small>2.20 x 62.4</small> | | |
| Other | _____ | lbs = _____ ft ³ | _____ lbs |
| | <small>_____ x 62.4</small> | | |
| Added Water: | _____ | lbs = _____ ft ³ | _____ lbs |
| | <small>1 x 62.4</small> | | |
| Air: | 27 x _____ | % = _____ ft ³ | |
| Volume of Paste | | _____ ft ³ (A) | |
| Volume of Aggregate: 27 - (A) | | _____ ft ³ (B) | |
| (B) x Aggregate Ratio = Volume of Each Aggregate | | | |
| Fine Aggregate | _____ | = _____ ft ³ x _____ | _____ lbs |
| | <small>(B) x %FA</small> | <small>(C) x SG</small> | |
| Coarse Aggregate | _____ | = _____ ft ³ x _____ | _____ lbs |
| | <small>(B) x %CA</small> | <small>(D) x SG</small> | |
| Check Volume: (A+C+D must = 27 ft ³) | | _____ ft ³ | |
| Total Weight per cu. yd. | | | _____ lbs/cu. yd. |

STEP 5A. To determine the minimum weight of fly ash required per cubic yard, subtract the final weight of cement (489 lbs) from the initial weight of cement (611 lbs).

$$611 - 489 = 122 \text{ lbs}$$

Round to the nearest pound!

STEP 5B. SCDOT policy (701.25) requires a replacement ratio for fly ash not less than 1.2:1. This means that for each pound of cement removed, a minimum of 1.2 lbs of fly ash must be used as a replacement.

$$122 \text{ lbs} \times 1.2 = 146 \text{ lbs}$$

Round to the nearest pound!

STEP 5C. Convert 146 lbs to a volume expressed in cubic feet by dividing the weight by the product of 2.25 x 62.4. Carry the answer for three decimal places.

Round to three decimal places!

| |
|--|
| Fly Ash: $\frac{146}{2.25 \times 62.4} \text{ lbs} = \underline{1.040 \text{ ft}^3}$ Yd ³ batch Weight <u>146</u> |
|--|



| CONCRETE BATCHING PER CUBIC YARD | | | | cu. yd batch weight |
|--|---|-----------------------|--------------------------------------|---------------------------------|
| Cement: | $\frac{489}{3.15 \times 62.4}$ | lbs = <u>2,488</u> | ft ³ | <u>489</u> lbs |
| Fly Ash | $\frac{146}{2.25 \times 62.4}$ | lbs = <u>1,040</u> | ft ³ | <u>146</u> lbs |
| Silica Fume | $\frac{\quad}{2.20 \times 62.4}$ | lbs = <u> </u> | ft ³ | <u> </u> lbs |
| Other | $\frac{\quad}{\quad \times 62.4}$ | lbs = <u> </u> | ft ³ | <u> </u> lbs |
| Added Water: | $\frac{1 \times 62.4}{\quad}$ | lbs = <u> </u> | ft ³ | <u> </u> lbs |
| Air: | 27 x <u> </u> | % = <u> </u> | ft ³ | |
| Volume of Paste | | | <u> </u> ft ³ | (A) |
| Volume of Aggregate: | 27 - (A) | | <u> </u> ft ³ | (B) |
| (B) x Aggregate Ratio = Volume of Each Aggregate | | | | |
| Fine Aggregate | $\frac{\quad}{(B)} \times \frac{\%FA}{\quad}$ | = $\frac{\quad}{(C)}$ | ft ³ x $\frac{\quad}{SG}$ | x 62.4 <u> </u> lbs |
| Coarse Aggregate | $\frac{\quad}{(B)} \times \frac{\%CA}{\quad}$ | = $\frac{\quad}{(D)}$ | ft ³ x $\frac{\quad}{SG}$ | x 62.4 <u> </u> lbs |
| Check Volume: | (A+C+D must = 27 ft ³) | | | <u> </u> ft ³ |
| Total Weight per cu. yd. | | | | <u> </u> lbs/cu.yd. |

STEP 6. Determine the total cementitious material weight by adding the cement and fly ash cubic yard batch weights. This value will be required to determine the amount of added water.

$$489 + 146 = \underline{635 \text{ lbs of cementitious material}}$$

| STRUCTURAL CONCRETE TABLE | | | | | |
|---------------------------|---------------------------------|--------------------------------------|------------------------------|--|----------------------------|
| Aggregate Type | Minimum Cement Content (lbs/CY) | Other Cementitious Material (lbs/CY) | Min. 28 Day Mix Design (psi) | Percent Fine to Coarse Aggregate Ratio | Max. Water to Cement Ratio |
| Class 4000 (see note 4) | | | | | |
| Crushed Stone | 611 | -- | 4000 | 35:65 | 0.40 |
| Gravel | 611 | -- | 4000 | 34:66 | 0.40 |



REMINDER: STEP 6. Determine the total cementitious material weight by adding the cement and fly ash cubic yard batch weights. This value will be required to determine the amount of added water.

$$489 + 146 = \underline{635 \text{ lbs of cementitious material}}$$

STEP 7. Determine the weight of added water necessary for one cubic yard of PCC by multiplying the water to cement ratio (w/c) found on the Structural Concrete Table by the total cementitious materials weight.

The w/c for class 4000 made with gravel is 0.40

$$0.40 \times 635 \text{ (lbs of cementitious material)} = 254 \text{ lbs} \quad \text{Round to the nearest pound!}$$

STEP 7. Determine the volume of added water by dividing the weight of added water by 62.4. (62.4 lbs is the weight of one cubic foot of water.)

| |
|--|
| Water: $\frac{254}{1.00 \times 62.4} \text{ lbs} = \underline{4.070 \text{ ft}^3}$ Yd ³ batch Weight <u>254</u> |
|--|



| CONCRETE BATCHING PER CUBIC YARD | | | |
|--|---|--|---------------------------------|
| | | | cu. yd batch weight |
| Cement: | $\frac{489}{3.15 \times 62.4}$ | lbs = $\underline{2.488}$ ft ³ | $\frac{489}{62.4}$ lbs |
| Fly Ash | $\frac{146}{2.25 \times 62.4}$ | lbs = $\underline{1.040}$ ft ³ | $\frac{146}{62.4}$ lbs |
| Silica Fume | $\frac{\quad}{2.20 \times 62.4}$ | lbs = $\underline{\quad}$ ft ³ | $\frac{\quad}{62.4}$ lbs |
| Other | $\frac{\quad}{\quad \times 62.4}$ | lbs = $\underline{\quad}$ ft ³ | $\frac{\quad}{62.4}$ lbs |
| Added Water: | $\frac{254}{1 \times 62.4}$ | lbs = $\underline{4.071}$ ft ³ | $\frac{254}{62.4}$ lbs |
| Air: | 27 x $\underline{\quad}$ % | = $\underline{\quad}$ ft ³ | |
| Volume of Paste | | $\underline{\quad}$ ft ³ (A) | |
| Volume of Aggregate: 27 - (A) | | $\underline{\quad}$ ft ³ (B) | |
| (B) x Aggregate Ratio = Volume of Each Aggregate | | | |
| Fine Aggregate | $\frac{\quad}{(B)} \times \frac{\%FA}{(C)}$ | = $\underline{\quad}$ ft ³ x $\frac{\quad}{SG}$ | x 62.4 $\underline{\quad}$ lbs |
| Coarse Aggregate | $\frac{\quad}{(B)} \times \frac{\%CA}{(D)}$ | = $\underline{\quad}$ ft ³ x $\frac{\quad}{SG}$ | x 62.4 $\underline{\quad}$ lbs |
| Check Volume: (A+C+D must = 27 ft ³) | | $\underline{\quad}$ ft ³ | |
| Total Weight per cu. yd. | | | $\underline{\quad}$ lbs/cu. yd. |

STEP 9. Determine the volume of entrained air (there is no weight component). To determine this volume, multiply the entrained air target value for SCDOT work, (4.5%) by 27.

$$27 \times 0.045 = 1.215 \text{ ft}^3$$

| | | |
|------|--------------|-----------------------------|
| Air: | 27 x 0.045 = | <u>1.215 ft³</u> |
|------|--------------|-----------------------------|



**CONCRETE BATCHING
PER CUBIC YARD**

| | | | | cu. yd batch weight |
|--|-------------------------------|-------|--------------------|-----------------------------------|
| Cement: | <u>489</u> | lbs = | <u>2.488</u> | ft ³ |
| | <small>3.15 x 62.4</small> | | | <u>489</u> |
| Fly Ash | <u>146</u> | lbs = | <u>1.040</u> | ft ³ |
| | <small>2.25 x 62.4</small> | | | <u>146</u> |
| Silica Fume | <u> </u> | lbs = | <u> </u> | ft ³ |
| | <small>2.20 x 62.4</small> | | | <u> </u> |
| Other | <u> </u> | lbs = | <u> </u> | ft ³ |
| | <small> x 62.4</small> | | | <u> </u> |
| Added Water: | <u>254</u> | lbs = | <u>4.071</u> | ft ³ |
| | <small>1 x 62.4</small> | | | <u>254</u> |
| Air: | 27 x <u>4.5</u> | % = | <u>1.215</u> | ft ³ |
| Volume of Paste | | | <u> </u> | ft ³ (A) |
| Volume of Aggregate: 27 - (A) | | | <u> </u> | ft ³ (B) |
| (B) x Aggregate Ratio = Volume of Each Aggregate | | | | |
| Fine Aggregate | | | | |
| | <u> </u> | x | <u> </u> | ft ³ |
| | <small>(B)</small> | | <small>%FA</small> | |
| | | = | <u> </u> | ft ³ x <u> </u> |
| | | | <small>(C)</small> | <small>SG</small> |
| | | | | x 62.4 <u> </u> lbs |
| Coarse Aggregate | | | | |
| | <u> </u> | x | <u> </u> | ft ³ |
| | <small>(B)</small> | | <small>%CA</small> | |
| | | = | <u> </u> | ft ³ x <u> </u> |
| | | | <small>(D)</small> | <small>SG</small> |
| | | | | x 62.4 <u> </u> lbs |
| Check Volume: (A+C+D must = 27 ft ³) | | | <u> </u> | ft ³ |
| Total Weight per cu. yd. | | | | <u> </u> lbs/cu. yd. |

STEP 10. Determine the volume of paste by summing the volumes of cement, fly ash, added water and air.

$$2.488 + 1.040 + 4.071 + 1.215 = \underline{8.814 \text{ ft}^3} \quad \text{Maintain (3) decimal places!}$$

| | |
|------------------|---------------------------------|
| Volume of Paste: | <u>8.814 ft³</u> (A) |
|------------------|---------------------------------|



| CONCRETE BATCHING PER CUBIC YARD | | | |
|--|--|---|----------------------------|
| Cement: | <u>489</u> <small>3.15 x 62.4</small> | lbs = <u>2.488</u> ft ³ | <u>489</u> lbs |
| Fly Ash | <u>146</u> <small>2.25 x 62.4</small> | lbs = <u>1.040</u> ft ³ | <u>146</u> lbs |
| Silica Fume | <u> </u> <small>2.20 x 62.4</small> | lbs = <u> </u> ft ³ | <u> </u> lbs |
| Other | <u> </u> <small> x 62.4</small> | lbs = <u> </u> ft ³ | <u> </u> lbs |
| Added Water: | <u>254</u> <small>1 x 62.4</small> | lbs = <u>4.071</u> ft ³ | <u>254</u> lbs |
| Air: | <u>27</u> x <u>4.5</u> % | = <u>1.215</u> ft ³ | |
| Volume of Paste | | <u>8.814</u> ft ³ (A) | |
| Volume of Aggregate: 27 - (A) | | <u> </u> ft ³ (B) | |
| (B) x Aggregate Ratio = Volume of Each Aggregate | | | |
| Fine Aggregate | | | |
| <u> </u> (B) | x <u> </u> %FA (C) | = <u> </u> ft ³ x <u> </u> SG | x 62.4 <u> </u> lbs |
| Coarse Aggregate | | | |
| <u> </u> (B) | x <u> </u> %CA (D) | = <u> </u> ft ³ x <u> </u> SG | x 62.4 <u> </u> lbs |
| Check Volume: (A+C+D must = 27 ft ³) <u> </u> ft ³ | | | |
| Total Weight per cu. yd. <u> </u> lbs/cu. yd. | | | |

STEP 11. Determine the volume of aggregate that will be required per cubic yard by subtracting the volume of paste from 27 ft³.

$$27.000 - 8.814 = \underline{18.186 \text{ ft}^3}$$

Maintain (3) decimal places!

| | | |
|-------------------------------|------------------------------|-----|
| Volume of Aggregate: 27 – (A) | <u>18.186 ft³</u> | (B) |
|-------------------------------|------------------------------|-----|



**CONCRETE BATCHING
PER CUBIC YARD**

| | | | | cu. yd batch weight |
|---|-----------------------------|-------|--------------------|-------------------------|
| Cement: | <u>489</u> | lbs = | <u>2.488</u> | ft ³ |
| | <small>3.15 x 62.4</small> | | | <u>489</u> |
| Fly Ash | <u>146</u> | lbs = | <u>1.040</u> | ft ³ |
| | <small>2.25 x 62.4</small> | | | <u>146</u> |
| Silica Fume | _____ | lbs = | _____ | ft ³ |
| | <small>2.20 x 62.4</small> | | | _____ |
| Other | _____ | lbs = | _____ | ft ³ |
| | <small>_____ x 62.4</small> | | | _____ |
| Added Water: | <u>254</u> | lbs = | <u>4.071</u> | ft ³ |
| | <small>1 x 62.4</small> | | | <u>254</u> |
| Air: | 27 x <u>4.5</u> | % = | <u>1.215</u> | ft ³ |
| Volume of Paste | | | <u>8.814</u> | ft ³ (A) |
| Volume of Aggregate: 27 – (A) | | | <u>18.186</u> | ft ³ (B) |
| (B) x Aggregate Ratio = Volume of Each Aggregate | | | | |
| Fine Aggregate | _____ | x | _____ | ft ³ |
| | <small>(B)</small> | | <small>%FA</small> | |
| | | = | _____ | ft ³ x _____ |
| | | | <small>(C)</small> | <small>SG</small> |
| | | | | x 62.4 _____ |
| | | | | lbs |
| Coarse Aggregate | _____ | x | _____ | ft ³ |
| | <small>(B)</small> | | <small>%CA</small> | |
| | | = | _____ | ft ³ x _____ |
| | | | <small>(D)</small> | <small>SG</small> |
| | | | | x 62.4 _____ |
| | | | | lbs |
| Check Volume (A+C+D must = 27 ft ³) | | | _____ | ft ³ |
| Total Weight per cu. yd. | | | _____ | lbs/cu. yd. |

| CONCRETE BATCHING PER CUBIC YARD | | | | cu. yd batch weight |
|--|---|-----------------------|--------------------------------------|----------------------------|
| Cement: | $\frac{489}{3.15 \times 62.4}$ | lbs = <u>2.488</u> | ft ³ | <u>489</u> lbs |
| Fly Ash | $\frac{146}{2.25 \times 62.4}$ | lbs = <u>1.040</u> | ft ³ | <u>146</u> lbs |
| Silica Fume | $\frac{\quad}{2.20 \times 62.4}$ | lbs = <u> </u> | ft ³ | <u> </u> lbs |
| Other | $\frac{\quad}{\quad \times 62.4}$ | lbs = <u> </u> | ft ³ | <u> </u> lbs |
| Added Water: | $\frac{254}{1 \times 62.4}$ | lbs = <u>4.071</u> | ft ³ | <u>254</u> lbs |
| Air: | 27×4.5 | % = <u>1.215</u> | ft ³ | |
| Volume of Paste | | <u>8.814</u> | ft ³ (A) | |
| Volume of Aggregate: 27 - (A) | | <u>18.186</u> | ft ³ (B) | |
| (B) x Aggregate Ratio = Volume of Each Aggregate | | | | |
| Fine Aggregate | $\frac{\quad}{(B)} \times \frac{\%FA}{\quad}$ | = $\frac{\quad}{(C)}$ | ft ³ x $\frac{\quad}{SG}$ | x 62.4 <u> </u> lbs |
| Coarse Aggregate | $\frac{\quad}{(B)} \times \frac{\%CA}{\quad}$ | = $\frac{\quad}{(D)}$ | ft ³ x $\frac{\quad}{SG}$ | x 62.4 <u> </u> lbs |
| Check Volume: (A+C+D must = 27 ft ³) | | | <u> </u> | ft ³ |
| Total Weight per cu. yd. | | | | <u> </u> lbs/cu.yd. |

| CONCRETE BATCHING PER CUBIC YARD | | | | cu. yd batch weight |
|--|--|-----------------------|--------------------------------------|----------------------------|
| Cement: | $\frac{489}{3.15 \times 62.4}$ | lbs = <u>2.488</u> | ft ³ | <u>489</u> lbs |
| Fly Ash | $\frac{146}{2.25 \times 62.4}$ | lbs = <u>1.040</u> | ft ³ | <u>146</u> lbs |
| Silica Fume | $\frac{\quad}{2.20 \times 62.4}$ | lbs = <u> </u> | ft ³ | <u> </u> lbs |
| Other | $\frac{\quad}{\quad \times 62.4}$ | lbs = <u> </u> | ft ³ | <u> </u> lbs |
| Added Water: | $\frac{254}{1 \times 62.4}$ | lbs = <u>4.071</u> | ft ³ | <u>254</u> lbs |
| Air: | 27×4.5 | % = <u>1.215</u> | ft ³ | |
| Volume of Paste | | <u>8.814</u> | ft ³ (A) | |
| Volume of Aggregate: 27 - (A) | | <u>18.186</u> | ft ³ (B) | |
| (B) x Aggregate Ratio = Volume of Each Aggregate | | | | |
| Fine Aggregate | $\frac{18.186}{(B)} \times \frac{\%FA}{\quad}$ | = $\frac{\quad}{(C)}$ | ft ³ x $\frac{\quad}{SG}$ | x 62.4 <u> </u> lbs |
| Coarse Aggregate | $\frac{18.186}{(B)} \times \frac{\%CA}{\quad}$ | = $\frac{\quad}{(D)}$ | ft ³ x $\frac{\quad}{SG}$ | x 62.4 <u> </u> lbs |
| Check Volume: (A+C+D must = 27 ft ³) | | | <u> </u> | ft ³ |
| Total Weight per cu. yd. | | | | <u> </u> lbs/cu.yd. |

STEP 12. Determine the volume of Fine aggregate that will be required per cubic yard by multiplying the appropriate percentage of fine aggregate by the total volume of aggregate (labeled (B)) For this example, the ratio of fine:coarse aggregate is given as **34:36** (based on the type of coarse aggregate) in the Structural Concrete Table.

| STRUCTURAL CONCRETE TABLE | | | | | |
|---------------------------|---------------------------------|--------------------------------------|------------------------------|--|----------------------------|
| Aggregate Type | Minimum Cement Content (lbs/CY) | Other Cementitious Material (lbs/CY) | Min. 28 Day Mix Design (psi) | Percent Fine to Coarse Aggregate Ratio | Max. Water to Cement Ratio |
| Class 4000 (see note 4) | | | | | |
| Crushed Stone | 611 | -- | 4000 | 35:65 | 0.40 |
| Gravel | 611 | -- | 4000 | 34:66 | 0.40 |



| CONCRETE BATCHING PER CUBIC YARD | | | |
|--|---|-------|--|
| Cement: | $\frac{489}{3.15 \times 62.4}$ | lbs = | $\frac{2,488}{ft^3}$ |
| Fly Ash | $\frac{146}{2.25 \times 62.4}$ | lbs = | $\frac{1,040}{ft^3}$ |
| Silica Fume | $\frac{\quad}{2.20 \times 62.4}$ | lbs = | $\frac{\quad}{ft^3}$ |
| Other | $\frac{\quad}{\quad \times 62.4}$ | lbs = | $\frac{\quad}{ft^3}$ |
| Added Water: | $\frac{254}{1 \times 62.4}$ | lbs = | $\frac{4,071}{ft^3}$ |
| Air: | 27×4.5 | % = | $\frac{1,215}{ft^3}$ |
| Volume of Paste | | | $\frac{8.814}{ft^3}$ (A) |
| Volume of Aggregate: 27 - (A) | | | $\frac{18.186}{ft^3}$ (B) |
| (B) x Aggregate Ratio = Volume of Each Aggregate | | | |
| Fine Aggregate | $\frac{18.186}{(B)} \times \frac{0.34}{\%FA}$ | = | $\frac{\quad}{ft^3} \times \frac{\quad}{SG} \times 62.4$ lbs |
| Coarse Aggregate | $\frac{18.186}{(B)} \times \frac{0.66}{\%CA}$ | = | $\frac{\quad}{ft^3} \times \frac{\quad}{(D) SG} \times 62.4$ lbs |
| Check Volume: (A+C+D must = 27 ft ³) | | | $\frac{\quad}{ft^3}$ |
| Total Weight per cu. yd. | | | $\frac{\quad}{lbs/cu. yd.}$ |

| CONCRETE BATCHING PER CUBIC YARD | | | | cu. yd batch weight |
|--|---|-----------------------|---------------------------------------|----------------------------|
| Cement: | $\frac{489}{3.15 \times 62.4}$ | lbs = <u>2.488</u> | ft ³ | <u>489</u> lbs |
| Fly Ash | $\frac{146}{2.25 \times 62.4}$ | lbs = <u>1.040</u> | ft ³ | <u>146</u> lbs |
| Silica Fume | $\frac{\quad}{2.20 \times 62.4}$ | lbs = <u> </u> | ft ³ | <u> </u> lbs |
| Other | $\frac{\quad}{\quad \times 62.4}$ | lbs = <u> </u> | ft ³ | <u> </u> lbs |
| Added Water: | $\frac{254}{1 \times 62.4}$ | lbs = <u>4.071</u> | ft ³ | <u>254</u> lbs |
| Air: | $\frac{27 \times 4.5}{\quad}$ | % = <u>1.215</u> | ft ³ | |
| Volume of Paste | | <u>8.814</u> | ft ³ (A) | |
| Volume of Aggregate: 27 - (A) | | <u>18.186</u> | ft ³ (B) | |
| (B) x Aggregate Ratio = Volume of Each Aggregate | | | | |
| Fine Aggregate | $\frac{18.186}{(B)} \times \frac{0.34}{\%FA}$ | = <u>6.183</u> | ft ³ x $\frac{\quad}{(C)}$ | x 62.4 <u> </u> lbs |
| Coarse Aggregate | $\frac{18.186}{(B)} \times \frac{0.66}{\%CA}$ | = <u> </u> | ft ³ x $\frac{\quad}{(D)}$ | x 62.4 <u> </u> lbs |
| Check Volume: (A+C+D must = 27 ft ³) | | | <u> </u> | ft ³ |
| Total Weight per cu. yd. | | | | <u> </u> lbs/cu.yd. |

Develop the Mix Proportions for a Class 4000 PCC using SCDOT Guidelines.

Class 4000 Concrete.

Design the Mix such that 20% of the cement is replaced with fly Ash.

| | | | |
|------------------|--------|------------------------------|---------------------|
| Coarse Aggregate | Gravel | Specific Gravity (SG) = 2.70 | 1% Moisture Content |
| Fine Aggregate | Sand | Specific Gravity (SG) = 2.68 | 4% Moisture Content |

Determine the required weight of each component to batch a total of 6 cubic yards.

Cement _____
 Fly Ash _____
 Silica Fume _____
 Added Water _____
 Fine Aggregate _____
 Coarse Aggregate _____

How many gallons of **Added Water** were required? _____

STEP 13. Review the problem statement to find the fine aggregate specific gravity. Transfer this value to the correct space as shown. (In this example, the fine aggregate SG was **2.68** and the coarse aggregate SG was **2.70**)

STEP 14. Using the volume of fine aggregate, its specific gravity and the **62.4** conversion factor, calculate the weight of fine aggregate per cubic yard.

$$18.186 \times 34\% = 6.183 \text{ ft}^3$$

Round to three decimal places!

$$6.183 \times 2.68 \times 62.4 = 1034 \text{ lbs}$$

Round to the nearest pound!

$$\text{Fine Aggregate: } \frac{18.186}{(B)} \times \frac{34\%}{\%FA} = \frac{6.183 \text{ ft}^3}{(C)} \times \frac{2.68}{SG} \times 62.4 = 1034 \text{ lbs}$$



CONCRETE BATCHING
PER CUBIC YARD

| | | | | cu. yd batch weight |
|--|---|-------|--|------------------------------|
| Cement: | $\frac{489}{3.15 \times 62.4}$ | lbs = | $\frac{2.488}{1}$ ft ³ | $\frac{489}{1}$ lbs |
| Fly Ash | $\frac{146}{2.25 \times 62.4}$ | lbs = | $\frac{1.040}{1}$ ft ³ | $\frac{146}{1}$ lbs |
| Silica Fume | $\frac{\quad}{2.20 \times 62.4}$ | lbs = | $\frac{\quad}{1}$ ft ³ | $\frac{\quad}{1}$ lbs |
| Other | $\frac{\quad}{\quad \times 62.4}$ | lbs = | $\frac{\quad}{1}$ ft ³ | $\frac{\quad}{1}$ lbs |
| Added Water: | $\frac{254}{1 \times 62.4}$ | lbs = | $\frac{4.071}{1}$ ft ³ | $\frac{254}{1}$ lbs |
| Air: | $\frac{27 \times 4.5}{100}$ | % = | $\frac{1.215}{1}$ ft ³ | |
| Volume of Paste | | | $\frac{8.814}{1}$ ft ³ (A) | |
| Volume of Aggregate: 27 - (A) | | | $\frac{18.186}{1}$ ft ³ (B) | |
| (B) x Aggregate Ratio = Volume of Each Aggregate | | | | |
| Fine Aggregate | $\frac{18.186}{(B)} \times \frac{0.34}{\%FA}$ | = | $\frac{6.183}{(C)}$ ft ³ x $\frac{2.68}{SG}$ | $\frac{1034}{1}$ lbs |
| Coarse Aggregate | $\frac{18.186}{(B)} \times \frac{0.66}{\%CA}$ | = | $\frac{\quad}{(D)}$ ft ³ x $\frac{\quad}{SG}$ | $\frac{\quad}{1}$ lbs |
| Check Volume: (A+C+D must = 27 ft ³) | | | $\frac{\quad}{1}$ ft ³ | |
| Total Weight per cu. yd. | | | | $\frac{\quad}{1}$ lbs/cu.yd. |

STEP 15-17. Repeat steps 12-14 for the coarse aggregate using the correct coarse aggregate percentage and the appropriate SG value.

$$18.186 \times 66\% = 12.003 \text{ ft}^3$$

Round to three decimal places!

| | |
|-------------------|---|
| Coarse Aggregate: | $\frac{18.186}{(B)} \times \frac{66\%}{\%CA} = \frac{12.003 \text{ ft}^3}{(D)} \times \frac{2.70}{SG} \times 62.4 = \underline{2022 \text{ lbs}}$ |
|-------------------|---|



CONCRETE BATCHING
PER CUBIC YARD

| | | | | cu. yd batch weight | |
|--|--|-------------------|------------------------------------|---------------------|-----------------|
| Cement: | $\frac{489}{3.15 \times 62.4}$ | lbs = | $\frac{2.488}{1}$ ft ³ | <u>489</u> | lbs |
| Fly Ash | $\frac{146}{2.25 \times 62.4}$ | lbs = | $\frac{1.040}{1}$ ft ³ | <u>146</u> | lbs |
| Silica Fume | $\frac{\quad}{2.20 \times 62.4}$ | lbs = | $\frac{\quad}{1}$ ft ³ | <u> </u> | lbs |
| Other | $\frac{\quad}{\quad \times 62.4}$ | lbs = | $\frac{\quad}{1}$ ft ³ | <u> </u> | lbs |
| Added Water: | $\frac{254}{1 \times 62.4}$ | lbs = | $\frac{4.071}{1}$ ft ³ | <u>254</u> | lbs |
| Air: | $\frac{1}{27} \times 4.5$ | % = | $\frac{1.215}{1}$ ft ³ | | |
| Volume of Paste | | | $\frac{8.814}{1}$ ft ³ | (A) | |
| Volume of Aggregate: 27 - (A) | | | $\frac{18.186}{1}$ ft ³ | (B) | |
| (B) x Aggregate Ratio = Volume of Each Aggregate | | | | | |
| Fine Aggregate | $\frac{18.186}{(B)} \times \frac{0.34}{\%FA} = \frac{6.183}{(C)}$ | ft ³ x | $\frac{2.68}{SG}$ | x 62.4 | <u>1034</u> lbs |
| Coarse Aggregate | $\frac{18.186}{(B)} \times \frac{0.66}{\%CA} = \frac{12.003}{(D)}$ | ft ³ x | $\frac{2.70}{SG}$ | x 62.4 | <u>2022</u> lbs |
| Check Volume: (A+C+D must = 27 ft ³) | | | <u> </u> | ft ³ | |
| Total Weight per cu. yd | | | | | lbs/cu yd |

STEP 18. Perform a volume check. If the combined volumes of paste, fine aggregate and coarse aggregate do not equal 27 ft³, then a mistake has been made.

$$A + C + D \text{ must} = 27 \text{ ft}^3$$

Check Volume: (A) 8.814 + (C) 6.183 + (D) 12.003 = 27 ft³



CONCRETE BATCHING
PER CUBIC YARD

| | | | | cu. yd batch weight | |
|--|---|-------|----------------------|---------------------|--|
| Cement: | $\frac{489}{3.15 \times 62.4}$ | lbs = | $\frac{2,488}{1}$ | ft ³ | $\frac{489}{1}$ lbs |
| Fly Ash | $\frac{146}{2.25 \times 62.4}$ | lbs = | $\frac{1,040}{1}$ | ft ³ | $\frac{146}{1}$ lbs |
| Silica Fume | $\frac{\quad}{2.20 \times 62.4}$ | lbs = | $\frac{\quad}{1}$ | ft ³ | $\frac{\quad}{1}$ lbs |
| Other | $\frac{\quad}{\quad \times 62.4}$ | lbs = | $\frac{\quad}{1}$ | ft ³ | $\frac{\quad}{1}$ lbs |
| Added Water: | $\frac{254}{1 \times 62.4}$ | lbs = | $\frac{4,071}{1}$ | ft ³ | $\frac{254}{1}$ lbs |
| Air: | $\frac{27 \times 4.5}{100}$ | % = | $\frac{1,215}{1}$ | ft ³ | |
| Volume of Paste | | | $\frac{8,814}{1}$ | ft ³ | (A) |
| Volume of Aggregate: 27 - (A) | | | $\frac{18,186}{1}$ | ft ³ | (B) |
| (B) x Aggregate Ratio = Volume of Each Aggregate | | | | | |
| Fine Aggregate | $\frac{18,186}{(B)} \times \frac{0.34}{\%FA}$ | = | $\frac{6,183}{(C)}$ | ft ³ | $\frac{2,68}{SG} \times 62.4$ $\frac{1034}{1}$ lbs |
| Coarse Aggregate | $\frac{18,186}{(B)} \times \frac{0.66}{\%CA}$ | = | $\frac{12,003}{(D)}$ | ft ³ | $\frac{2,70}{SG} \times 62.4$ $\frac{2022}{1}$ lbs |
| Check Volume: (A+C+D must = 27 ft ³) | | | $\frac{27.00}{1}$ | ft ³ | |
| Total Weight per cu. yd. | | | | | lbs/cu.yd. |



Develop the Mix Proportions for a Class 4000 PCC using SCDOT Guidelines.

Class 4000 Concrete.

Design the Mix such that 20% of the cement is replaced with fly Ash.

| | | | |
|------------------|--------|------------------------------|---------------------|
| Coarse Aggregate | Gravel | Specific Gravity (SG) = 2.70 | 1% Moisture Content |
| Fine Aggregate | Sand | Specific Gravity (SG) = 2.68 | 4% Moisture Content |

Determine the required weight of each component to batch a total of 6 cubic yards.

Cement _____
 Fly Ash _____
 Silica Fume _____
 Added Water _____
 Fine Aggregate _____
 Coarse Aggregate _____

How many gallons of **Added Water** were required? _____

STEP 19. Although now the form is now complete, the process of designing the mix is not. The aggregates each contain moisture, and this water must be accounted for in the mix preparation. The problem statement says that the fine aggregate has a moisture percentage of 4% and the coarse aggregate has 1% moisture beyond SSD conditions. To determine what the weight of aggregate moisture is – multiply the individual aggregate weights by their respective moisture contents as shown.

Fine Aggregate weight: **1034 lbs**

$$1034 \times 4\% = 41 \text{ lbs}$$

Round to the nearest pound!

Coarse Aggregate weight: **2022 lbs**

$$2022 \times 1\% = 20 \text{ lbs}$$

Round to the nearest pound!



STEP 20-21. The weights of 41 lbs and 20 lbs represent the weight of water that would enter the mix via the aggregates. The inclusion of this water also means that the weight of fine aggregate entering the mix is actually less than the 1034 measured. The same reasoning applies to the coarse aggregate. To compensate, 41 lbs of fine aggregate must be added to the mix design value of 1034 lbs. Also, 20 lbs of coarse aggregate must be added to the design weight of 2022 lbs.

Adjusted Fine Aggregate weight: $1034 + 41 = 1075$ lbs

Adjusted Coarse Aggregate weight: $2022 + 20 = 2042$ lbs

Fine Aggregate:
$$\frac{18.186}{(B)} \times \frac{34\%}{\%FA} = \frac{6.183 \text{ ft}^3}{(C)} \times \frac{2.68}{SG} \times 62.4 = \underline{1034 \text{ lbs}}$$

Adj. Wt. = $1034 + 41 = 1075$ lbs

Coarse Aggregate:
$$\frac{18.186}{(B)} \times \frac{66\%}{\%CA} = \frac{12.003 \text{ ft}^3}{(D)} \times \frac{2.70}{SG} \times 62.4 = \underline{2022 \text{ lbs}}$$

Adj. Wt. = $2022 + 20 = 2042$ lbs



**CONCRETE BATCHING
PER CUBIC YARD**

| | | | | cu. yd batch weight |
|--|-------------------------------|-------|---------------------|---------------------------------|
| Cement: | <u>489</u> | lbs = | <u>2.488</u> | <u>489</u> lbs |
| | <small>3.15 x 62.4</small> | | | |
| Fly Ash | <u>146</u> | lbs = | <u>1.040</u> | <u>146</u> lbs |
| | <small>2.25 x 62.4</small> | | | |
| Silica Fume | <u> </u> | lbs = | <u> </u> | <u> </u> lbs |
| | <small>2.20 x 62.4</small> | | | |
| Other | <u> </u> | lbs = | <u> </u> | <u> </u> lbs |
| | <small> x 62.4</small> | | | |
| Added Water: | <u>254</u> | lbs = | <u>4.071</u> | <u>254</u> lbs |
| | <small>1 x 62.4</small> | | | |
| Air: | <u>27</u> x <u>4.5</u> | % = | <u>1.215</u> | <u> </u> ft ³ |
| Volume of Paste | | | <u>8.814</u> | ft ³ (A) |
| Volume of Aggregate: 27 - (A) | | | <u>18.186</u> | ft ³ (B) |
| (B) x Aggregate Ratio = Volume of Each Aggregate | | | | |
| Fine Aggregate | <u>18.186</u> | x | <u>0.34</u> | = |
| | <small>(B)</small> | | <small>%FA</small> | |
| | | = | <u>6.183</u> | ft ³ x |
| | | | <small>(C)</small> | |
| | | | <small>2.68</small> | SG x 62.4 = |
| | | | | <u>1034</u> lbs |
| Coarse Aggregate | <u>18.186</u> | x | <u>0.66</u> | = |
| | <small>(B)</small> | | <small>%CA</small> | |
| | | = | <u>12.003</u> | ft ³ x |
| | | | <small>(D)</small> | |
| | | | <small>2.70</small> | SG x 62.4 = |
| | | | | <u>2022</u> lbs |
| | | | | <u>2022 + 20 = 2042</u> |
| Check Volume: (A+C+D must = 27 ft ³) | | | <u>7.00</u> | ft ³ |
| Total Weight per cu. yd. | | | | <u> </u> lbs/cu. yd. |

STEP 22. The weights of 41 lbs and 20 lbs that represent the weight of water entering the mix via the aggregates, must be subtracted from the quantity of added water. To compensate, 41 lbs of water must be subtracted because of the fine aggregate moisture and 20 lbs of water must be subtracted because of the coarse aggregate moisture.

$$\text{Added Water} - \text{Fine Agg. Moisture} - \text{Coarse Agg. Moisture} = \text{Adj. Added Water Weight}$$

| | | |
|------------------------------|-------------------|----------------|
| Adjusted Added Water weight: | $254 - 41 - 20 =$ | 193 lbs |
|------------------------------|-------------------|----------------|



**CONCRETE BATCHING
PER CUBIC YARD**

| | | | | cu. yd batch weight |
|--|---|-------|--------------------------------------|-------------------------------|
| Cement: | $\frac{489}{3.15 \times 62.4}$ | lbs = | $\frac{2.488}{1}$ | $\frac{489}{62.4}$ lbs |
| Fly Ash | $\frac{146}{2.25 \times 62.4}$ | lbs = | $\frac{1.040}{1}$ | $\frac{146}{62.4}$ lbs |
| Silica Fume | $\frac{\quad}{2.20 \times 62.4}$ | lbs = | $\frac{\quad}{1}$ | $\frac{\quad}{62.4}$ lbs |
| Other | $\frac{\quad}{\quad \times 62.4}$ | lbs = | $\frac{\quad}{1}$ | $\frac{\quad}{62.4}$ lbs |
| Added Water: | $\frac{254}{1 \times 62.4}$ | lbs = | $\frac{4.071}{1}$ | $\frac{254}{62.4}$ lbs |
| Air: | $\frac{27 \times 4.5}{1 \times 62.4}$ | % = | $\frac{1.215}{1}$ | - 41 - 20 |
| Volume of Paste | | | $\frac{8.814}{1}$ | (A) $\frac{193}{62.4}$ lbs |
| Volume of Aggregate: 27 - (A) | | | $\frac{18.186}{1}$ | (B) |
| (B) x Aggregate Ratio = Volume of Each Aggregate | | | | |
| Fine Aggregate | $\frac{18.186}{(B)} \times \frac{0.34}{\%FA}$ | = | $\frac{6.183}{(C)}$ | $\frac{2.68}{SG} \times 62.4$ |
| Coarse Aggregate | $\frac{18.186}{(B)} \times \frac{0.66}{\%CA}$ | = | $\frac{12.003}{(D)}$ | $\frac{2.70}{SG} \times 62.4$ |
| Adj. Wt. | | | $\frac{1034 + 41}{2022 + 20} = 2042$ | |
| Check Volume: (A+C+D must = 27 ft ³) | | | $\frac{7.00}{1}$ | ft ³ |
| Total Weight per cu. yd. | | | | lbs/cu. yd. |

STEP 23-24. Total the weights of the components to obtain the total weight per cubic yard for this mix.

| | |
|----------------------------|-----------------|
| Cement | 489 |
| Fly Ash | 146 |
| Silica Fume | 0 |
| Added Water | 193 |
| Fine Aggregate | 1075 |
| Coarse Aggregate | 2042 |
| Mix Wt./ cubic yard | 3945 lbs |



| CONCRETE BATCHING PER CUBIC YARD | | | |
|--|--|--|------------------------------------|
| Cement: | $\frac{489}{3.15 \times 62.4}$ | lbs = <u>2.488</u> ft ³ | cu. yd batch weight <u>489</u> lbs |
| Fly Ash | $\frac{146}{2.25 \times 62.4}$ | lbs = <u>1.040</u> ft ³ | <u>146</u> lbs |
| Silica Fume | $\frac{\quad}{2.20 \times 62.4}$ | lbs = <u> </u> ft ³ | <u> </u> lbs |
| Other | $\frac{\quad}{\quad \times 62.4}$ | lbs = <u> </u> ft ³ | <u> </u> lbs |
| Added Water: | $\frac{254}{1 \times 62.4}$ | lbs = <u>4.071</u> ft ³ | <u>254</u> lbs |
| Air: | $\frac{27 \times 4.5}{\quad}$ | % = <u>1.215</u> ft ³ | - 41 - 20 |
| Volume of Paste | | <u>8.814</u> ft ³ (A) | <u>193 lbs</u> |
| Volume of Aggregate: 27 - (A) | | <u>18.186</u> ft ³ (B) | |
| (B) x Aggregate Ratio = Volume of Each Aggregate | | | |
| Fine Aggregate | $\frac{18.186}{(B)} \times \frac{0.34}{\%FA} = \frac{6.183}{(C)}$ | ft ³ x $\frac{2.68}{SG}$ x 62.4 | <u>1034</u> lbs |
| Coarse Aggregate | $\frac{18.186}{(B)} \times \frac{0.66}{\%CA} = \frac{12.003}{(D)}$ | ft ³ x $\frac{2.70}{SG}$ x 62.4 | <u>2022</u> lbs |
| | | | <u>2022 + 20 = 2042</u> |
| Check Volume: (A+C+D must = 27 ft ³) | | <u>7.00</u> ft ³ | |
| Total Weight per cu. yd. | | | lbs/cu.yd. |

STEP 23-24. Total the weights of the components to obtain the total weight per cubic yard for this mix.

| | |
|----------------------------|-----------------|
| Cement | 489 |
| Fly Ash | 146 |
| Silica Fume | 0 |
| Added Water | 193 |
| Fine Aggregate | 1075 |
| Coarse Aggregate | 2042 |
| Mix Wt./ cubic yard | 3945 lbs |



| CONCRETE BATCHING PER CUBIC YARD | | | | cu. yd batch weight |
|--|---|-------|---|------------------------------|
| Cement: | $\frac{489}{3.15 \times 62.4}$ | lbs = | $\frac{2,488}{1}$ ft ³ | $\frac{489}{1}$ lbs |
| Fly Ash | $\frac{146}{2.25 \times 62.4}$ | lbs = | $\frac{1,040}{1}$ ft ³ | $\frac{146}{1}$ lbs |
| Silica Fume | $\frac{\quad}{2.20 \times 62.4}$ | lbs = | $\frac{\quad}{1}$ ft ³ | $\frac{\quad}{1}$ lbs |
| Other | $\frac{\quad}{\quad \times 62.4}$ | lbs = | $\frac{\quad}{1}$ ft ³ | $\frac{\quad}{1}$ lbs |
| Added Water: | $\frac{254}{1 \times 62.4}$ | lbs = | $\frac{4,071}{1}$ ft ³ | $\frac{254}{1}$ lbs |
| Air: | $\frac{27 \times 4.5}{1}$ | % = | $\frac{1,215}{1}$ ft ³ | - 41 |
| | | | | - 20 |
| Volume of Paste | | | $\frac{8,814}{1}$ ft ³ (A) | 193 lbs |
| Volume of Aggregate: 27 - (A) | | | $\frac{18,186}{1}$ ft ³ (B) | |
| (B) x Aggregate Ratio = Volume of Each Aggregate | | | | |
| Fine Aggregate | $\frac{18,186}{(B)} \times \frac{0.34}{\%FA}$ | = | $\frac{6,183}{(C)}$ ft ³ x $\frac{2.68}{SG}$ x 62.4 | $\frac{1034}{1}$ lbs |
| Coarse Aggregate | $\frac{18,186}{(B)} \times \frac{0.66}{\%CA}$ | = | $\frac{12,003}{(D)}$ ft ³ x $\frac{2.70}{SG}$ x 62.4 | $\frac{2022}{1}$ lbs |
| | | | | $\frac{2022 + 20}{1} = 2042$ |
| Check Volume: (A+C+D must = 27 ft ³) | | | $\frac{7.00}{1}$ ft ³ | |
| Total Weight per cu. yd. | | | $\frac{3945}{1}$ lbs/cu.yd. | |

Develop the Mix Proportions for a Class 4000 PCC using SCDOT Guidelines.

Determine the required weight of each component to batch a total of 6 cubic yards.

Cement _____
 Fly Ash _____
 Silica Fume _____
 Added Water _____
 Fine Aggregate _____
 Coarse Aggregate _____

How many gallons of **Added Water** were required? _____

STEP 25. Multiply the single yard weights by the appropriate number of yards to determine the total weight of each mix component called for in the problem statement.

| | Weight per Yd ³ | Totals for 6 Cubic Yards |
|----------------------------|----------------------------|--------------------------|
| Cement | 489 | 2934 lbs |
| Fly Ash | 146 | 876 lbs |
| Silica Fume | 0 | 0 |
| Added Water | 193 | 1158 lbs |
| Fine Aggregate | 1075 | 6450 lbs |
| Coarse Aggregate | 2042 | 12252 lbs |
| Mix Wt./ cubic yard | 3945 lbs | 23670 lbs |



Develop the Mix Proportions for a Class 4000 PCC using SCDOT Guidelines.

Determine the required weight of each component to batch a total of 6 cubic yards.

| | |
|------------------|---------------|
| Cement | <u>2,934</u> |
| Fly Ash | <u>876</u> |
| Silica Fume | <u>0</u> |
| Added Water | <u>1,158</u> |
| Fine Aggregate | <u>6,450</u> |
| Coarse Aggregate | <u>12,252</u> |

How many gallons of **Added Water** were required? _____



STEP 26. Determine the total volume of **Added Water** required by dividing the total weight of water in pounds by **8.33**, to obtain the total volume of water in gallons.

$$\text{Added Water weight : } \frac{1158 \text{ lbs}}{8.33 \text{ lbs/gal}} = 139 \text{ gal}$$

Round down to the previous gallon!



**Develop the Mix Proportions for a Class 4000 PCC
using SCDOT Guidelines.**

Determine the required weight of each component to batch a total of 6 cubic yards.

| | |
|------------------|---------------|
| Cement | <u>2,934</u> |
| Fly Ash | <u>876</u> |
| Silica Fume | <u>0</u> |
| Added Water | <u>1,158</u> |
| Fine Aggregate | <u>6,450</u> |
| Coarse Aggregate | <u>12,252</u> |

How many gallons of **Added Water** were required? 139

6.1 Moisture Correction for Fine and Coarse Aggregates using the Dry Method

The moisture content in aggregates must be considered when batching concretes to assure consistency and to control total water content in the concrete mixture. Not taking into account the free moisture on the aggregates can lead to exceeding specified water to cement ratios and can lessen the durability of the concrete structure, as well as lower the compressive and flexural strengths.

ASTM C 566 or AASHTO T 255 Standard Test Method for Total Evaporable Moisture Content by Drying gives guidance in the proper way to determine the moisture content to aggregates so that proper adjustments can be made to the concrete mixture to account for this free moisture. This method can also be used to check the calibration of moisture probes and moisture meters.

In this exercise, we will look at the oven or hot plate method to determine the moisture content of an aggregate when that aggregate is completely dried, however a microwave oven can also be used.

The size of the sample that is needed to perform the test is a function of the nominal maximum aggregate particle size, therefore different sample sizes are needed for different size aggregates. The sample size needed can be found in a table listed in the test methods listed above.

The formula used to determine the moisture content of the aggregate is:

$$p = \left(\frac{W - D}{D} \right) * 100$$

Where:

p = Total moisture content of sample at SSD in percent

W = Mass of original sample in grams

D = Mass of dried sample in grams

However, this will determine the total moisture content of the aggregate and you will need to determine only the surface moisture content of aggregate due to the fact that the concrete mix design was based on the saturate surface dried (SSD) aggregate. Therefore it is necessary at account for the absorbance of the aggregate and:

The formula used to determine the SSD moisture content of the aggregate is:

$$S = \left(\frac{W - D}{D} \right) * 100 - A$$

Where:

S = Total moisture content of sample at SSD in percent

W = Mass of original sample in grams

D = Mass of dried sample in grams

A = Absorption of the aggregate in percent

Mix Proportion Development

Example Q1

Develop the mix proportioning for a CLASS 2500 Concrete having 5% of the cement replaced with fly ash using the following aggregate:

| | | |
|-----------------------------|------------------------------|-------------|
| Coarse Aggregate / L. Stone | Specific Gravity (SG) = 2.74 | 2% moisture |
| Fine Aggregate | Specific Gravity (SG) = 2.68 | 2% moisture |

A mix proportion form is provided at the end of this exam booklet.

If 14 cubic yards of this mix is required, determine:

- total *weight* of:
- cement
 - fly ash _____
 - silica fume _____
 - added water _____
 - fine aggregate _____
 - coarse aggregate _____

total *volume* of **added** water required (Gal) _____

number of ready mix trucks required: _____

Mix Proportion Development

Example Q2

Develop the mix proportioning for a CLASS 3000 Concrete having 6% of the cement replaced with fly ash using the following aggregate:

| | | |
|----------------------------|------------------------------|-------------|
| Coarse Aggregate / Crushed | Specific Gravity (SG) = 2.91 | 1% moisture |
| Fine Aggregate | Specific Gravity (SG) = 2.68 | 3% moisture |

A mix proportion form is provided at the end of this exam booklet.

If 10 cubic yards of this mix is required, determine:

| | | |
|-------------------------|------------------|-------|
| total <i>weight</i> of: | cement | |
| | fly ash | _____ |
| | silica fume | _____ |
| | added water | _____ |
| | fine aggregate | _____ |
| | coarse aggregate | _____ |

total *volume* of **added** water required (Gal) _____

number of ready mix trucks required: _____

Mix Proportion Development

Example Q3

Develop the mix proportioning for a CLASS 7000 Concrete having 8% of the cement replaced with fly ash using the following aggregate:

| | | |
|----------------------------|------------------------------|-------------|
| Coarse Aggregate / Crushed | Specific Gravity (SG) = 2.47 | 1% moisture |
| Fine Aggregate | Specific Gravity (SG) = 2.68 | 3% moisture |

A mix proportion form is provided at the end of this exam booklet.

If 18 cubic yards of this mix is required, determine:

| | | |
|-------------------------|------------------|-------|
| total <i>weight</i> of: | cement | |
| | fly ash | _____ |
| | silica fume | _____ |
| | added water | _____ |
| | fine aggregate | _____ |
| | coarse aggregate | _____ |

total *volume* of **added** water required (Gal) _____

number of ready mix trucks required: _____

Mix Proportion Development

Example Q4

Develop the mix proportioning for a CLASS 4000 Concrete having 20% of the cement replaced with fly ash using the following aggregate:

| | | |
|---------------------------|------------------------------|-------------|
| Coarse Aggregate / Gravel | Specific Gravity (SG) = 2.70 | 1% moisture |
| Fine Aggregate / Sand | Specific Gravity (SG) = 2.68 | 4% moisture |

If 6 cubic yards of this mix is required, determine:

- total *weight* of:
 - cement _____
 - fly ash _____
 - silica fume _____
 - added** water _____
 - fine aggregate _____
 - coarse aggregate _____

Volume of **added** water required in Gallons: _____

Mix Proportion Development

Example Q5

Develop the mix proportioning for a CLASS 6500 Concrete using the following aggregate:

| | | |
|----------------------------|------------------------------|-------------|
| Coarse Aggregate / Crushed | Specific Gravity (SG) = 2.69 | 1% moisture |
| Fine Aggregate / Sand | Specific Gravity (SG) = 2.61 | 4% moisture |

If 3.5 cubic yards of this mix is required, determine:

- total *weight* of:
- cement _____
 - fly ash _____
 - silica fume _____
 - added** water _____
 - fine aggregate _____
 - coarse aggregate _____

Volume of **added** water required in Gallons: _____

Mix Proportion Development

Example Q6

Develop the mix proportioning for a CLASS 5000 Concrete having 10% of the cement replaced with fly ash using the following aggregate:

| | | |
|----------------------------|------------------------------|-------------|
| Coarse Aggregate / Crushed | Specific Gravity (SG) = 2.70 | 1% moisture |
| Fine Aggregate / Sand | Specific Gravity (SG) = 2.68 | 6% moisture |

If 24 cubic yards of this mix is required, determine:

- total *weight* of:
 - cement
 - fly ash _____
 - silica fume _____
 - added** water _____
 - fine aggregate _____
 - coarse aggregate _____

Volume of **added** water required in Gallons: _____

Concrete Mix Proportion Development Calculator

Answer Q1

Fill in the appropriate values to the shaded areas to complete the calculations. Enter percentages as decmille values.

Cement Information

Concrete Type: Class: 2500

Number of Yds³ to be batched:

FA Replacement % (decimile):

Max Water to Cement Ratio:

Aggregate Information

Fine Coarse

L. Stone

Ratio Total should = 100%

100%

(revised for new specs. 8/9/2005)

Weight (lb) Vol (ft³)

Initial Cement/Yd³:

Final Cement: 469

Fly Ash: 30

Total Cementitious: 499

Initial Water: 279

Final Water: 216

Air: 0

Paste: N/A

Free Volume: 18.714

Fine Aggregate

18.714

Free Vol

0.4

FA %

7.486

Volume

2.68

Spc Grav

FA

Coarse Aggregate

18.714

Free Vol

0.6

CA %

11.228

Volume

2.74

Spc Grav

CA

Vol Check: should = 27

Final Wts: 27.000

Cement: 469

Fly Ash: 30

Water: 216

Fine Ag: 1,277

Coarse Ag: 1,958

Total /Yd³: 3,950

Total Yds³=

14

Total Vol of added water (Gal)

6,566

420

3,024

17,878

27,412

55,300

= 363

Concrete Mix Proportion Development Calculator

Answer Q3

Fill in the appropriate values to the shaded areas to complete the calculations. Enter percentages as decmille values.

Cement Information

| | | |
|--|-------|-------------|
| Concrete Type | Class | 7000 |
| Number of Yds ³ to be batched | 18 | Type |
| FA Replacement % (decimile) | 0.08 | Ratio |
| Max Water to Cement Ratio | 0.37 | % Moisture |
| | | Spec. Grav. |

Aggregate Information

| | | |
|------|---------|---------------------------|
| Fine | Crushed | Ratio Total Should = 100% |
| Sand | 0.65 | 100% |
| 0.35 | 0.01 | |
| 0.03 | 2.47 | |
| 2.68 | | |

| | | | | | | |
|--------------------|-------------|--------|------------------------|--|--|--|
| Initial Cement | Weight (lb) | 800 | Vol (ft ³) | | | |
| Final Cement | 736 | 3.744 | | | | |
| Fly Ash | 77 | 0.548 | | | | |
| Total Cementitious | 813 | | | | | |
| Initial Water | 301 | | | | | |
| Final Water | 255 | | | | | |
| Air | 0 | 1.215 | | | | |
| Paste | N/A | 10.331 | | | | |
| Free Volume | | 16.669 | | | | |

| | | | | | | |
|------------------|------|----------|-----------|------------|----------|--|
| Fine Aggregate | | | | | | |
| 16.669 | 0.35 | 5.834 | 976 | 29 | 1005 | |
| Free Vol | FA % | Volume | Init. Wt. | Additional | Final Wt | |
| | | FA | FA | FA | FA | |
| | | 2.68 | | | | |
| | | Spc Grav | | | | |
| | | FA | | | | |
| Coarse Aggregate | | | | | | |
| 16.669 | 0.65 | 10.835 | 1670 | 17 | 1687 | |
| Free Vol | CA % | Volume | Init. Wt. | Additional | Final Wt | |
| | | CA | CA | CA | CA | |
| | | 2.47 | | | | |
| | | Spc Grav | | | | |
| | | CA | | | | |

| | | | | | |
|-----------------------------|---------------------|--------|--------------------------|----|--------------------------------|
| Vol Check | <u>Should = 27</u> | 27.000 | Total Yds ³ = | 18 | Total Vol of added water (Gal) |
| Final Wts | Lbs/Yd ³ | | | | = 551 |
| Cement | 736 | | 13,248 | | |
| Fly Ash | 77 | | 1,386 | | |
| Water | 255 | | 4,590 | | |
| Fine Ag. | 1,005 | | 18,090 | | |
| Coarse Ag | 1,687 | | 30,366 | | |
| Total Yd³ | 3,760 | | 67,680 | | |

Concrete Mix Proportion Development Calculator

Answer Q4

Fill in the appropriate values to the shaded areas to complete the calculations. Enter percentages as decmille values.

Cement Information

| | | |
|--|-------------|------|
| Concrete Type | Class | 4000 |
| Number of Yds ³ to be batched | Type | 6 |
| FA Replacement % (decimile) | Ratio | 0.2 |
| Max Water to Cement Ratio | % Moisture | 0.4 |
| | Spec. Grav. | 2.7 |

Aggregate Information

| | |
|------|--------|
| Fine | Gravel |
| Sand | 0.66 |
| 0.34 | 0.01 |
| 0.04 | 2.7 |
| 2.68 | |

Ratio Total Should = 100%
100%

| | | | | | | | |
|--------------------|-------------|------------------------|------------------|----------|----------|------------|----------|
| Initial Cement | Weight (lb) | Vol (ft ³) | Fine Aggregate | 6.183 | 1034 | 41 | 1075 |
| Final Cement | 611 | 2.488 | Free Vol | Volume | Init.Wt. | Additional | Final Wt |
| Fly Ash | 489 | 1.040 | FA % | FA | FA | FA | FA |
| Total Cementitious | 146 | 635 | | Spc Grav | | | |
| Initial Water | 254 | 4.071 | Coarse Aggregate | 2.7 | 2022 | 20 | 2042 |
| Final Water | 193 | | Free Vol | CA | Init.Wt. | Additional | Final Wt |
| Air | 0 | 1.215 | 18.186 | Volume | CA | CA | CA |
| Paste | N/A | 8.814 | FA % | CA | CA | CA | CA |
| Free Volume | 18.186 | | | CA | CA | CA | CA |

| | | | | | |
|-----------------------------|---------------------|---------------|--------------------------|---|--------------------------------|
| Vol Check | <u>Should = 27</u> | 27.000 | Total Yds ³ = | 6 | Total Vol of added water (Gal) |
| | | | | | = 139 |
| Final Wts | Lbs/Yd ³ | | | | |
| Cement | 489 | 2,934 | | | |
| Fly Ash | 146 | 876 | | | |
| Water | 193 | 1,158 | | | |
| Fine Ag. | 1,075 | 6,450 | | | |
| Coarse Ag | 2,042 | 12,252 | | | |
| Total Yd³ | 3,945 | 23,670 | | | |

Class 6500 Mix Proportion Development Calculator

Answer Q5

Fill in the appropriate values to the shaded areas to complete the calculations. Enter percentages as decimal values.

Cement Information

Concrete Type Class 6500

Number of Yds³ to be batched 3.5

Type Ratio

Max Water to Cement Ratio 0.37
 % Moisture Spec. Grav. 2.61

Aggregate Information

Fine Coarse

Sand 0.37

Crushed 0.63

Ratio 0.04

% Moisture 0.01

Spec. Grav. 2.69

Ratio Total Should = 100%

100%

Weight (lb) Vol (ft³)

Initial Cement/Yd³ 500 2.544

Fly Ash 140 0.997

Silica Fume 35 0.255

Total Cementitious 675

Initial Water 250 4.006

Final Water 188

Air 0 1.215

Paste N/A 9.017

Free Volume 17.983

Fine Aggregate

17.983 0.37

Free Vol FA %

6.654

Volume FA

2.61

Spc Grav FA

1084

Init.Wt. FA

43

Additional FA

1127

Final Wt FA

Coarse Aggregate

17.983 0.63

Free Vol CA %

11.329

Volume CA

2.69

Spc Grav CA

1902

Init.Wt. CA

19

Additional CA

1921

Final Wt CA

Vol Check Should = 27

27.000

Total Yds³=

3.5

Total Vol of added water (Gal)

= 79

Final Wts Lbs/Yd³

Cement 500

Fly Ash 140

Silica Fume 35

Water 188

Fine Ag. 1,127

Coarse Ag 1,921

Total Yd³ 3,911

3.5

1,750

490

123

658

3,945

6,724

13,689

Concrete Mix Proportion Development Calculator

Answer Q6

Fill in the appropriate values to the shaded areas to complete the calculations. Enter percentages as decimile values.

Cement Information

| | | |
|--|-------------|------|
| Concrete Type | Class | 5000 |
| Number of Yds ³ to be batched | Type | 24 |
| FA Replacement % (decimile) | Ratio | 0.1 |
| Max Water to Cement Ratio | % Moisture | 0.46 |
| | Spec. Grav. | 2.7 |

Aggregate Information

| | | |
|------|---------|----------------------------------|
| Fine | Crushed | |
| Sand | 0.65 | <u>Ratio Total Should = 100%</u> |
| 0.35 | 0.01 | 100% |
| 0.06 | 2.7 | |

| | | |
|--------------------|-------------|------------------------|
| Initial Cement | Weight (lb) | Vol (ft ³) |
| Final Cement | 705 | |
| Fly Ash | 635 | 3.231 |
| Total Cementitious | 84 | 0.598 |
| Initial Water | 719 | |
| Final Water | 331 | 5.304 |
| Air | 254 | |
| Paste | 0 | 1.215 |
| Free Volume | N/A | 10.348 |
| | | 16.652 |

| | | | | | |
|------------------|----------|----------|-----------|------------|----------|
| Fine Aggregate | 0.35 | 5.828 | 975 | 59 | 1034 |
| Free Vol | FA % | Volume | Init. Wt. | Additional | Final Wt |
| 16.652 | 0.65 | FA | FA | FA | FA |
| Coarse Aggregate | 0.65 | 10.824 | 1824 | 18 | 1842 |
| Free Vol | CA % | Volume | Init. Wt. | Additional | Final Wt |
| 16.652 | 2.7 | CA | CA | CA | CA |
| Spc Grav | Spc Grav | Spc Grav | Spc Grav | Spc Grav | Spc Grav |
| 2.68 | 2.7 | 2.7 | 2.7 | 2.7 | 2.7 |

| | | | | | |
|------------------------------|--------------------|--------|--------------------------|---------------|--------------------------------|
| Vol Check | <u>Should = 27</u> | 27.000 | Total Yds ³ = | 24 | Total Vol of added water (Gal) |
| Cement | 635 | | | 15,240 | = 732 |
| Fly Ash | 84 | | | 2,016 | |
| Water | 254 | | | 6,096 | |
| Fine Ag. | 1,034 | | | 24,816 | |
| Coarse Ag | 1,842 | | | 44,208 | |
| Total /Yd³ | 3,849 | | | 92,376 | |

CONCRETE BATCHING
Per Cubic Yard

**Cu. Yd
Batch
Weight**

Cement: $\frac{\quad}{3.15 \times 62.4}$ lbs = $\frac{\quad}{\quad}$ ft³ $\frac{\quad}{\quad}$ lbs

Fly Ash: $\frac{\quad}{2.25 \times 62.4}$ lbs = $\frac{\quad}{\quad}$ ft³ $\frac{\quad}{\quad}$ lbs

Silica Fume: $\frac{\quad}{2.20 \times 62.4}$ lbs = $\frac{\quad}{\quad}$ ft³ $\frac{\quad}{\quad}$ lbs

Other: $\frac{\quad}{\quad \times 62.4}$ lbs = $\frac{\quad}{\quad}$ ft³ $\frac{\quad}{\quad}$ lbs

Added Water: $\frac{\quad}{1 \times 62.4}$ lbs = $\frac{\quad}{\quad}$ ft³ $\frac{\quad}{\quad}$ lbs

Air: 27 x $\frac{\quad}{\quad}$ % = $\frac{\quad}{\quad}$ ft³

Volume of Paste $\frac{\quad}{\quad}$ ft³ (A)

Volume of Aggregate: 27 - (A) $\frac{\quad}{\quad}$ ft³ (B)

(B) x Aggregate Ratio = Volume of Each Aggregate

Fine Aggregate

$\frac{\quad}{(B)} \times \frac{\quad}{\%FA} = \frac{\quad}{(C)} \text{ ft}^3 \times \frac{\quad}{SG} \times 62.4 = \frac{\quad}{\quad}$ lbs

Coarse Aggregate

$\frac{\quad}{(B)} \times \frac{\quad}{\%CA} = \frac{\quad}{(D)} \text{ ft}^3 \times \frac{\quad}{SG} \times 62.4 = \frac{\quad}{\quad}$ lbs

Check Volume (A + C + D must = 27 ft³) $\frac{\quad}{\quad}$ ft³

Total Weight per Cu. Yd. $\frac{\quad}{\quad}$ lbs/Cu.Yd.

CONCRETE BATCHING
Per Cubic Yard

**Cu. Yd
Batch
Weight**

Cement: $\frac{\quad}{3.15 \times 62.4}$ lbs = $\frac{\quad}{\quad}$ ft³ $\frac{\quad}{\quad}$ lbs

Fly Ash: $\frac{\quad}{2.25 \times 62.4}$ lbs = $\frac{\quad}{\quad}$ ft³ $\frac{\quad}{\quad}$ lbs

Silica Fume: $\frac{\quad}{2.20 \times 62.4}$ lbs = $\frac{\quad}{\quad}$ ft³ $\frac{\quad}{\quad}$ lbs

Other: $\frac{\quad}{\quad \times 62.4}$ lbs = $\frac{\quad}{\quad}$ ft³ $\frac{\quad}{\quad}$ lbs

Added Water: $\frac{\quad}{1 \times 62.4}$ lbs = $\frac{\quad}{\quad}$ ft³ $\frac{\quad}{\quad}$ lbs

Air: 27 x $\frac{\quad}{\quad}$ % = $\frac{\quad}{\quad}$ ft³

Volume of Paste $\frac{\quad}{\quad}$ ft³ (A)

Volume of Aggregate: 27 - (A) $\frac{\quad}{\quad}$ ft³ (B)

(B) x Aggregate Ratio = Volume of Each Aggregate

Fine Aggregate

$\frac{\quad}{(B)} \times \frac{\quad}{\%FA} = \frac{\quad}{(C)} \text{ ft}^3 \times \frac{\quad}{SG} \times 62.4 = \frac{\quad}{\quad} \text{ lbs}$

Coarse Aggregate

$\frac{\quad}{(B)} \times \frac{\quad}{\%CA} = \frac{\quad}{(D)} \text{ ft}^3 \times \frac{\quad}{SG} \times 62.4 = \frac{\quad}{\quad} \text{ lbs}$

Check Volume (A + C + D must = 27 ft³) $\frac{\quad}{\quad}$ ft³

Total Weight per Cu. Yd. $\frac{\quad}{\quad}$ lbs/Cu.Yd.

CONCRETE BATCHING
Per Cubic Yard

**Cu. Yd
Batch
Weight**

Cement: $\frac{\quad}{3.15 \times 62.4}$ lbs = $\frac{\quad}{\quad}$ ft³ $\frac{\quad}{\quad}$ lbs

Fly Ash: $\frac{\quad}{2.25 \times 62.4}$ lbs = $\frac{\quad}{\quad}$ ft³ $\frac{\quad}{\quad}$ lbs

Silica Fume: $\frac{\quad}{2.20 \times 62.4}$ lbs = $\frac{\quad}{\quad}$ ft³ $\frac{\quad}{\quad}$ lbs

Other: $\frac{\quad}{\quad \times 62.4}$ lbs = $\frac{\quad}{\quad}$ ft³ $\frac{\quad}{\quad}$ lbs

Added Water: $\frac{\quad}{1 \times 62.4}$ lbs = $\frac{\quad}{\quad}$ ft³ $\frac{\quad}{\quad}$ lbs

Air: 27 x $\frac{\quad}{\quad}$ % = $\frac{\quad}{\quad}$ ft³

Volume of Paste $\frac{\quad}{\quad}$ ft³ (A)

Volume of Aggregate: 27 - (A) $\frac{\quad}{\quad}$ ft³ (B)

(B) x Aggregate Ratio = Volume of Each Aggregate

Fine Aggregate

$\frac{\quad}{(B)} \times \frac{\quad}{\%FA} = \frac{\quad}{(C)} \text{ ft}^3 \times \frac{\quad}{SG} \times 62.4 = \frac{\quad}{\quad} \text{ lbs}$

Coarse Aggregate

$\frac{\quad}{(B)} \times \frac{\quad}{\%CA} = \frac{\quad}{(D)} \text{ ft}^3 \times \frac{\quad}{SG} \times 62.4 = \frac{\quad}{\quad} \text{ lbs}$

Check Volume (A + C + D must = 27 ft³) $\frac{\quad}{\quad}$ ft³

Total Weight per Cu. Yd. $\frac{\quad}{\quad}$ lbs/Cu.Yd.

CONCRETE BATCHING
Per Cubic Yard

**Cu. Yd
Batch
Weight**

Cement: $\frac{\quad}{3.15 \times 62.4}$ lbs = $\frac{\quad}{\quad}$ ft³ $\frac{\quad}{\quad}$ lbs

Fly Ash: $\frac{\quad}{2.25 \times 62.4}$ lbs = $\frac{\quad}{\quad}$ ft³ $\frac{\quad}{\quad}$ lbs

Silica Fume: $\frac{\quad}{2.20 \times 62.4}$ lbs = $\frac{\quad}{\quad}$ ft³ $\frac{\quad}{\quad}$ lbs

Other: $\frac{\quad}{\quad \times 62.4}$ lbs = $\frac{\quad}{\quad}$ ft³ $\frac{\quad}{\quad}$ lbs

Added Water: $\frac{\quad}{1 \times 62.4}$ lbs = $\frac{\quad}{\quad}$ ft³ $\frac{\quad}{\quad}$ lbs

Air: 27 x $\frac{\quad}{\quad}$ % = $\frac{\quad}{\quad}$ ft³

Volume of Paste $\frac{\quad}{\quad}$ ft³ (A)

Volume of Aggregate: 27 - (A) $\frac{\quad}{\quad}$ ft³ (B)

(B) x Aggregate Ratio = Volume of Each Aggregate

Fine Aggregate

$\frac{\quad}{(B)} \times \frac{\quad}{\%FA} = \frac{\quad}{(C)} \text{ ft}^3 \times \frac{\quad}{SG} \times 62.4 = \frac{\quad}{\quad}$ lbs

Coarse Aggregate

$\frac{\quad}{(B)} \times \frac{\quad}{\%CA} = \frac{\quad}{(D)} \text{ ft}^3 \times \frac{\quad}{SG} \times 62.4 = \frac{\quad}{\quad}$ lbs

Check Volume (A + C + D must = 27 ft³) $\frac{\quad}{\quad}$ ft³

Total Weight per Cu. Yd. $\frac{\quad}{\quad}$ lbs/Cu.Yd.

CONCRETE BATCHING
Per Cubic Yard

**Cu. Yd
Batch
Weight**

Cement: $\frac{\quad}{3.15 \times 62.4}$ lbs = $\frac{\quad}{\quad}$ ft³ $\frac{\quad}{\quad}$ lbs

Fly Ash: $\frac{\quad}{2.25 \times 62.4}$ lbs = $\frac{\quad}{\quad}$ ft³ $\frac{\quad}{\quad}$ lbs

Silica Fume: $\frac{\quad}{2.20 \times 62.4}$ lbs = $\frac{\quad}{\quad}$ ft³ $\frac{\quad}{\quad}$ lbs

Other: $\frac{\quad}{\quad \times 62.4}$ lbs = $\frac{\quad}{\quad}$ ft³ $\frac{\quad}{\quad}$ lbs

Added Water: $\frac{\quad}{1 \times 62.4}$ lbs = $\frac{\quad}{\quad}$ ft³ $\frac{\quad}{\quad}$ lbs

Air: 27 x $\frac{\quad}{\quad}$ % = $\frac{\quad}{\quad}$ ft³

Volume of Paste $\frac{\quad}{\quad}$ ft³ (A)

Volume of Aggregate: 27 - (A) $\frac{\quad}{\quad}$ ft³ (B)

(B) x Aggregate Ratio = Volume of Each Aggregate

Fine Aggregate

$\frac{\quad}{(B)} \times \frac{\quad}{\%FA} = \frac{\quad}{(C)} \text{ ft}^3 \times \frac{\quad}{SG} \times 62.4 = \frac{\quad}{\quad} \text{ lbs}$

Coarse Aggregate

$\frac{\quad}{(B)} \times \frac{\quad}{\%CA} = \frac{\quad}{(D)} \text{ ft}^3 \times \frac{\quad}{SG} \times 62.4 = \frac{\quad}{\quad} \text{ lbs}$

Check Volume (A + C + D must = 27 ft³) $\frac{\quad}{\quad}$ ft³

Total Weight per Cu. Yd. $\frac{\quad}{\quad}$ lbs/Cu.Yd.

CONCRETE BATCHING
Per Cubic Yard

**Cu. Yd
Batch
Weight**

Cement: $\frac{\quad}{3.15 \times 62.4}$ lbs = $\frac{\quad}{\quad}$ ft³ $\frac{\quad}{\quad}$ lbs

Fly Ash: $\frac{\quad}{2.25 \times 62.4}$ lbs = $\frac{\quad}{\quad}$ ft³ $\frac{\quad}{\quad}$ lbs

Silica Fume: $\frac{\quad}{2.20 \times 62.4}$ lbs = $\frac{\quad}{\quad}$ ft³ $\frac{\quad}{\quad}$ lbs

Other: $\frac{\quad}{\quad \times 62.4}$ lbs = $\frac{\quad}{\quad}$ ft³ $\frac{\quad}{\quad}$ lbs

Added Water: $\frac{\quad}{1 \times 62.4}$ lbs = $\frac{\quad}{\quad}$ ft³ $\frac{\quad}{\quad}$ lbs

Air: 27 x $\frac{\quad}{\quad}$ % = $\frac{\quad}{\quad}$ ft³

Volume of Paste $\frac{\quad}{\quad}$ ft³ (A)

Volume of Aggregate: 27 - (A) $\frac{\quad}{\quad}$ ft³ (B)

(B) x Aggregate Ratio = Volume of Each Aggregate

Fine Aggregate

$\frac{\quad}{(B)} \times \frac{\quad}{\%FA} = \frac{\quad}{(C)} \text{ ft}^3 \times \frac{\quad}{SG} \times 62.4 = \frac{\quad}{\quad} \text{ lbs}$

Coarse Aggregate

$\frac{\quad}{(B)} \times \frac{\quad}{\%CA} = \frac{\quad}{(D)} \text{ ft}^3 \times \frac{\quad}{SG} \times 62.4 = \frac{\quad}{\quad} \text{ lbs}$

Check Volume (A + C + D must = 27 ft³) $\frac{\quad}{\quad}$ ft³

Total Weight per Cu. Yd. $\frac{\quad}{\quad}$ lbs/Cu.Yd.

Chapter 7

Form 700.04

& Aggregate Sampling

SCDOT Form 700.04 is the reporting form for ready mix concrete batches. It is intended for QC/QA purposes in order to record and monitor:

- **Concrete origin, load, placing, time on site and mixing information**
- **Concrete slump and air content**
- **Actual concrete mix versus design proportions**
- **Water and admixture proportions and history**

Copies of Form 700.04 (US Units) are provided at the end of this section.

This section also contains step-by-step guidelines, an example tutorial for completing the Form 700.04, and a selection of practice problems and their solutions.

Guidelines for Completing the SCDOT Form 700.04

Filling out Form 700.04 will require the maximum water to cement ratio from the Structural Concrete Table, SCDOT Specifications Section 701. Additionally, a batch ticket or batch computer screen will be required to obtain the theoretical mix component weights and volumes. This guide refers to the standard mix design as the batch ticket or batch computer screen and the listing of the actual amounts of each material used. Lab Form 271 (R-02) OR Equivalent can be used to verify the SSD mix design material weights for one cubic yard. Titles that appear in “quotation marks” correspond to specific fields within the Form 700.04.

A bag of cement weighs 94 pounds.

STEPS

1. Read the Problem Statement.
2. Find the appropriate batch ticket or batch computer screen paying attention to class and additional cementitious materials.
3. Fill in basic batch information at the top of the form.
4. Fill in the appropriate individual weight values for cement(s), and the total cement weight as listed on the batch ticket or batch computer screen, for the appropriate batch size.
5. Fill in the coarse aggregate weight as listed on the batch ticket or batch computer screen typically listed as the “target weight”.
6. Fill in the sand weight for the specified sand percent moisture as listed on the batch ticket or batch computer screen.
7. Fill in the cumulative aggregate weight by adding aggregate values as listed on the batch ticket or batch computer screen.
8. Fill in the water weight and volume (gal) as listed on the batch ticket or batch computer screen to the appropriate blocks.
9. Calculate the allowable tolerances (weight ranges) for the cementitious materials (-1%), and for the aggregates ($\pm 2\%$). Round to the nearest pound.

10. Obtain the loading/dosage rates for any admixtures to be incorporated into the batch from the problem statement, fill in the *rate values given for the air entrainment agent, water reducing agent or retarding agent.
11. Calculate the amounts of air entrainment agent, water reducing agent or retarding agent to be added to the mix, based on the total amount of cement material specified for the mix.
12. Using the batch ticket values (actual proportions that are in the truck or central mixer) fill in the Actual Batch Weight values. Verify that a double batch was/was not required.
13. Determine the total cementitious material quantity by adding the cement, fly ash, and silica fume weights. Place this value in the appropriate space.
14. From the batch ticket obtain the actual batched water in gallons from the "Batched" column. *Some plants weigh water and it will already be given in pounds.* If the batch ticket does not give the weight of water in pounds, take the number of gallons and multiply by 8.33 to get the pounds to the nearest whole number.
15. Evaluate the actual batch weights to determine if they meet the acceptable "Theoretical Batch Values". Place a mark in the corresponding YES box for proportions that are within the acceptable range. Place a mark in the NO box for proportions that are outside of the acceptable range.
16.
 - a. Fill in the "Free Moisture Percent" spaces with the appropriate values. The values for the aggregate moistures are obtained from the Batch Ticket or Batch Computer Screen.
 - b. Calculate the "SSD Weight" of the aggregates by following the formula provided ** on the Form 700.04. Round to the nearest pound.
 - c. Determine the "Free Aggregate Moisture" by subtracting the "SSD Weight" from the "Actual Batch Weights" for each type of aggregate.
17. Transfer the actual amount of "Meter Water" added to the mix from the "Actual Batch Weight" column.

18. Obtain the "Total Water Added at the Plant" by summing the two "Free Aggregate Moistures" and the "Meter Water" weights.
19. Determine the "Maximum Water Allowed for the Mix AS Batched" by multiplying the correct w/c ratio by the "Actual Batch Weight for Total Cementitious Material".
20. Determine the "Max Water Allowed for Site Additions" by subtracting the "Total Water Added at Plant" from the "Max Water Allowed for the Mix AS Batched". Convert the weight of water into gallons by dividing the weight by 8.33.
21. Account for water added at site (this includes the water needed to modify slump). The general rule for increasing slump is that the addition of 1 gallon of water increases the slump of one cubic yard of concrete by 1 inch.
22. Determine the total weight of water in the load by adding the total weight of water from the plant to any water that was required for slump adjustments.
23. Calculate the Water to Cementitious Material Ratio by dividing the Total Water in the Load by the Total Cementitious Material's Actual Batch Weight.
24. Compare the load's w/c ratio to the maximum water/cement ratio listed in the Structural Concrete Table from the SCDOT Specification 701 to insure that this load of PCC meets the requirements set forth.
25. For Field Inspectors, fill out the On Site Batch Information based on acceptance test data, observations relevant to the load and times obtained from the truck driver.

Form 700.04

(Chapter 7)



FORM 700.04

This form is the reporting form for **ready mix concrete** batches. It is used for QC/QA purposes in acceptance and recording and monitoring:

- Concrete origin, load, time on site, and mixing information
- Used to make sure that the delivered concrete is within acceptable limits of SCDOT Specifications
- Record of the plastic properties of the concrete (air, slump, re-tempering with water and chemical additions of the concrete on site)
- Actual concrete mix versus design proportions



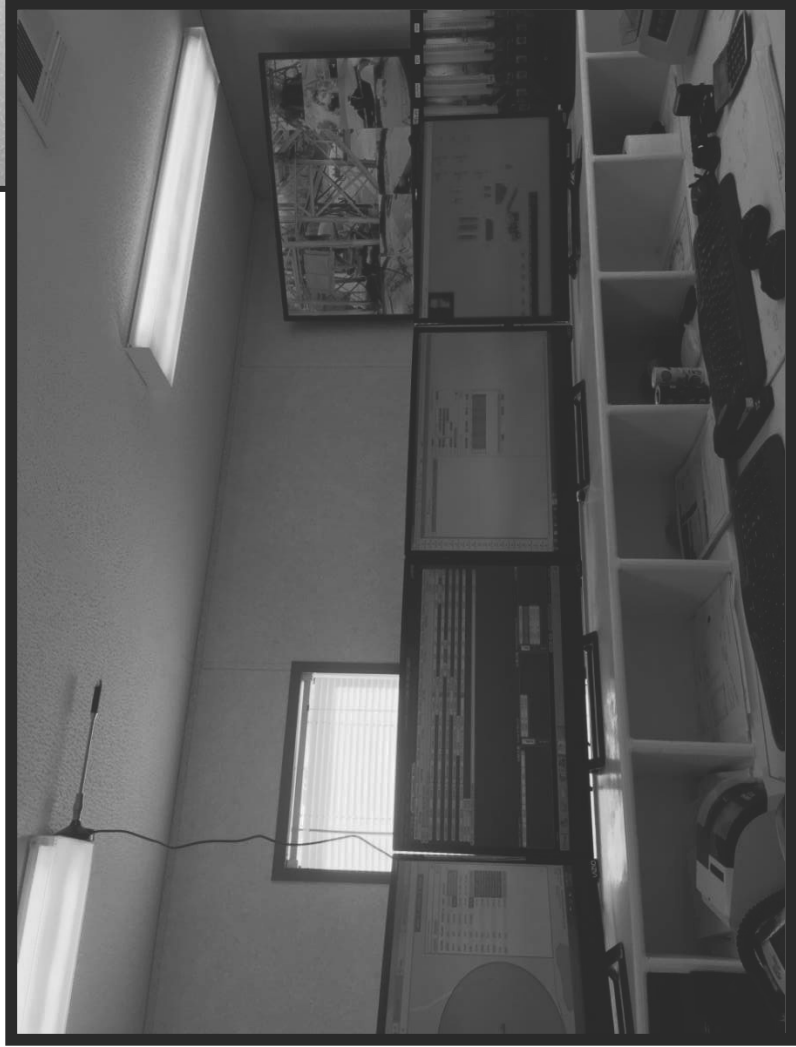

Concrete Batch Plants are starting to keep up with technology and it is getting easier to access the information you need.

Remember, some plants still use dial scales and they are acceptable. No printable batch ticket will be available and material weights will be determined by reading the scale values from the dial gauges.

Also remember that some plants weigh water and some use volumetric methods (typically gallons.)

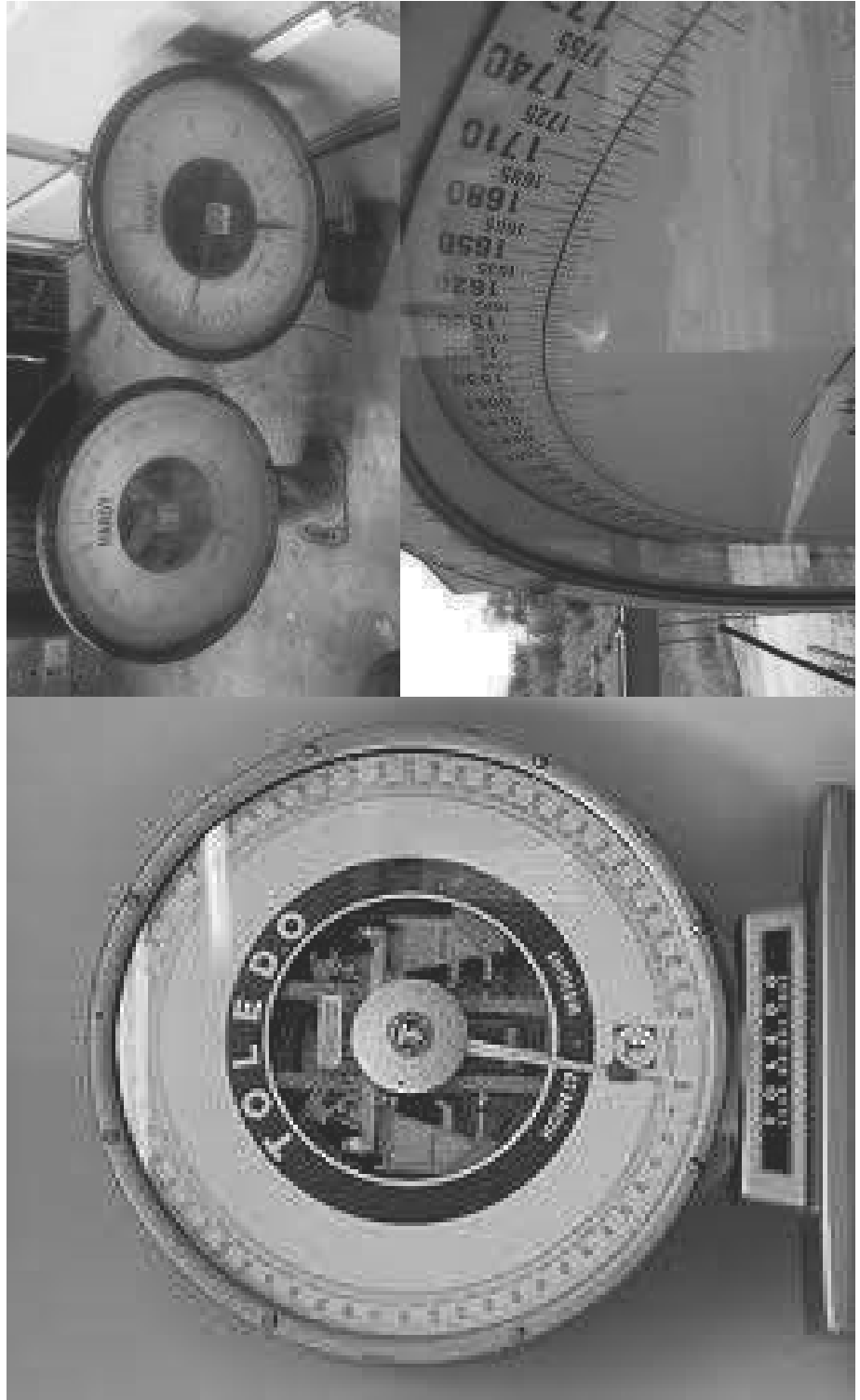

Lab Form 271 (R-02) OR
 Equivalent shall be stamped
 as Reviewed by the OMR.

“ 701.2.5.11 after successful
 review of a mix design by the
 OMR, do not change the mix
 proportions for the concrete
 of that class unless
 modifications are necessary
 and are approved in advance. ”



SOUTH CAROLINA DEPARTMENT OF TRANSPORTATION
 Concrete Mix Proposal/Fly Ash-Slag (other)

Company ABC Ready Mix
 Address 123 Nowhere St
 Individual to Contact John Doe Phone No. 803-555-1234
 Testing Agency _____
 Address _____
 Individual to Contact _____ Phone No. _____
 Class of Concrete Class 5000 with Fly Ash Special Mix _____

| Material | Source | Trade Name | Sp. Grav. SSD Used | Amt./Cu. Yd. SSD |
|---------------------|--------------------|----------------------|--------------------|----------------------|
| Cement | Holcim | Holly Hill Type /III | 3.15 | 6.000 Bag/ 564 lb |
| Fly Ash | SEFA | Approved sources | 2.25 | 1.796 Bag/ 168 lb |
| Slag Mod. | | | 3.05 | 0.000 Bag/ lb |
| Silica Fume | | | 2.20 | 0.000 lb |
| DCI | | | 1.30 | 0.000 gal |
| Other Cor.Inhibitor | Sumter County Sand | Sumter, SC | 2.63 | 1117 lb |
| Fine Agg. | | | | 0 lb |
| Int. Agg. | Martin Marietta | Cayce | 2.63 | 1675 lb |
| Coarse Agg | | | | 0 lb |
| Inter. Cr. Agg | W.R. Grace | Darex II | NR | As Nec. oz. |
| Admix 1 | W.R. Grace | Zylia 620 | NR | As Nec. oz. |
| Admix 2 | W.R. Grace | Recover | NR | As Nec. oz. |
| Admix 3 | W.R. Grace | ADVA 198 | NR | As Nec. oz. |
| Admix 4 | | | NR | As Nec. oz. |
| Water | | | 1.00 | gal. 35.18 293.20 lb |

Date(s) of Mix _____ Performed By: _____ Slump _____ in
 Air Content _____ % By _____ Pressure Meter _____ Rollometer _____
 Unit Weight 141.4 lbs/Cu.Ft. The yield 27.00 Cu.Ft.
 Average Compressive Strength _____ PSI @ 3 Days _____ PSI @ 7 Days _____
 _____ PSI @ 28 Days _____
 Percent of Fine Aggregate to total Aggregate by Volume 40.00 %
 Percent of Int. Aggregate to total Aggregate by Volume 0.00 %
 Percent of Coarse Aggregate to total Aggregate by Volume 60.00 %
 Percent of Inter. Cr. Aggregate to total Aggregate by Volume 0.00 %
 Must Total 100%
 Total Cementitious Material 733.0 (lb) divided by 94 = 7.798 bags
 Total gallons of water 35.18 divided by 7.798 bags = 4.51
 Total lbs of water 293.20 divided by total cementitious 733.0 W/C Ratio
 Designed % Air 4.50 % Range 3% to 6%

| | Bag Mix |
|--------|---------|
| Cement | 94 |
| FA | 143 |
| IA | 0 |
| CA | 215 |
| ICA | 0 |
| Water | 4.51 |

Comments _____

SCDOT OFFICE OF MATERIALS AND RESEARCH

REVIEWED
 REVIEWED - COMMENTS IN RED
 REVISE AND RESUBMIT
 NOT REVIEWED-INCOMPLETE SUBMITTAL

AmCole 12-25-16
 CONCRETE SUPERVISOR DATE

Signed By: _____
 Date: _____

Return To: South Carolina Department of Transportation
 Office of Materials and Research
 Attn: Concrete Section
 P. O. Box 191
 Columbia, SC 29202
 Fax (803) 737-6649

Lab Form 271(R-02)

From the Batch Panel Screen, they can pull up the SSD Mix Design that is being used. You can see that this is Mix: 956

Are the same mix proportions used on the Form 271 (R-02)?

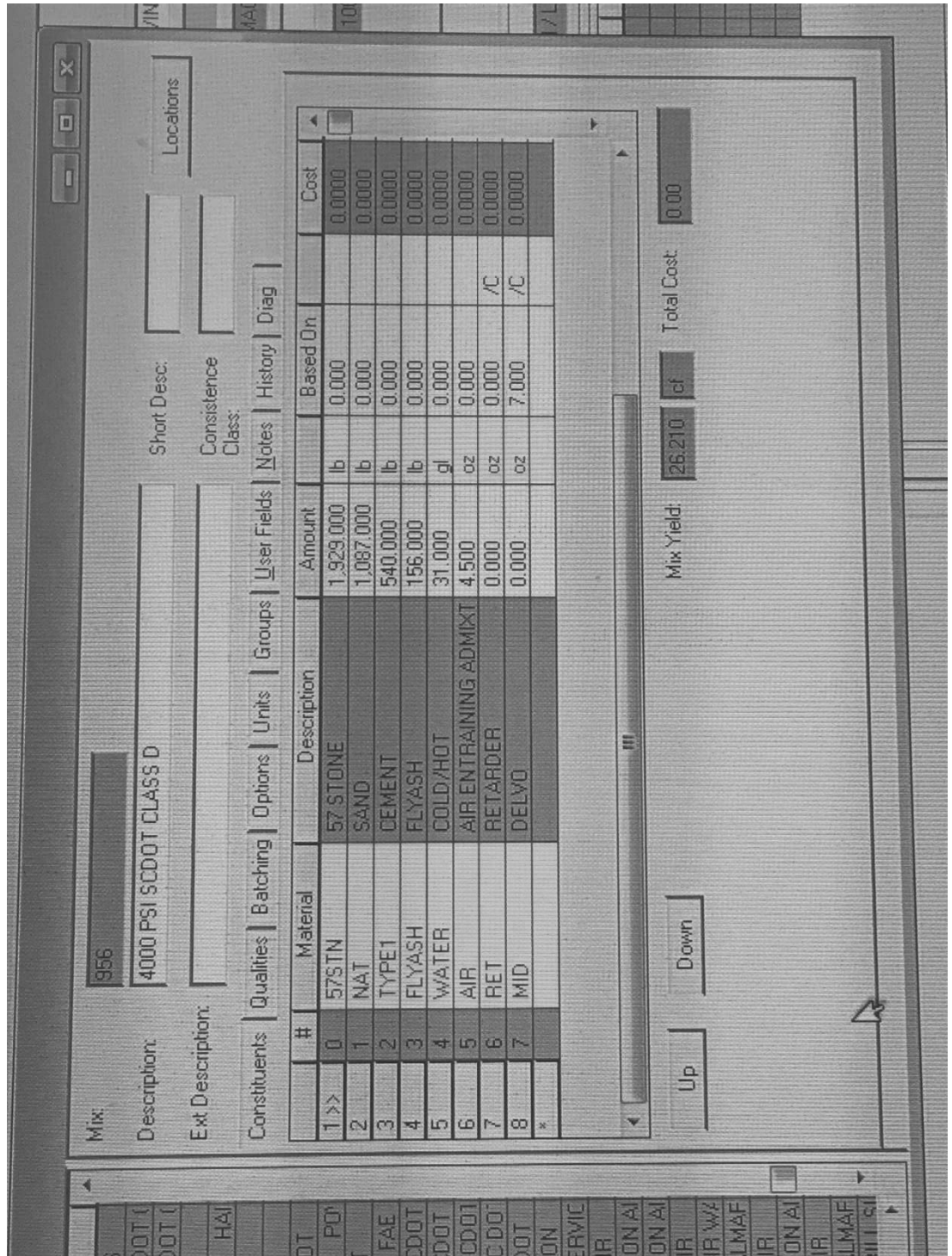

The theoretical batch weights adjusted for the aggregate moistures can be obtained from the batch computer screen or a printout of the batch ticket.

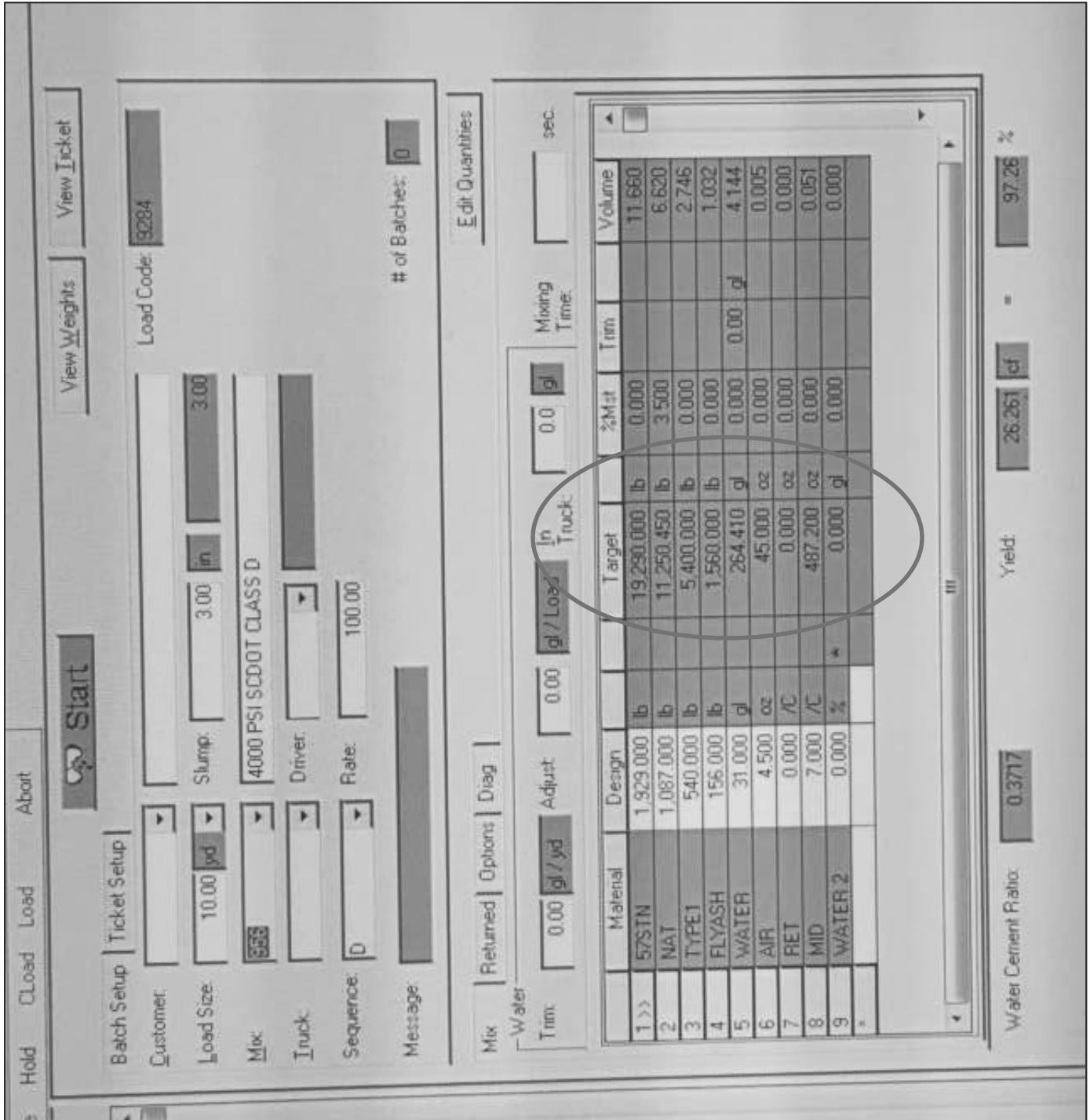

Unless the Batch Ticket has been approved by the OMR for use as an alternative to the 700.04 (Supplemental Specification 04/05/10)

The values at the bottom of the batch ticket shall not be used!

| Truck | Driver | User | Disp | Ticket |
|-----------|------------|-----------|-----------|------------------|
| Load Size | Mix Code | Returned | Qty | |
| 10.00 yd | 956 | | | |
| Material | Design Qty | Required | Batched | % Var % Moisture |
| 57STN | 1929 lb | 19290 lb | 19125 lb | -0.86% |
| NAT | 1087 lb | 11250 lb | 11142 lb | -0.96% |
| TYPE1 | 540.0 lb | 5400.0 lb | 5419.8 lb | 0.37% |
| FLYASH | 156.0 lb | 1560.0 lb | 1545.7 lb | -0.92% |
| WATER | 31.00 gl | 264.41 gl | 265.28 gl | 0.33% |
| AIR | 4.50 oz | 45.00 oz | 46.69 oz | 3.76% |
| MID | .00 /C # | .00 oz | .00 oz | |

FORM 700.04 - EXAMPLE Q1

STEP 1. Read the Problem Statement.

Total Concrete required for the pour:

70 cubic yards, delivered by seven trucks carrying 10 cubic yards each.

Class 3000 Concrete with 6% Fly Ash

| AGGREGATES | AGGREGATE TYPE | SPECIFIC GRAVITY | MOISTURE PERCENTAGE |
|------------|----------------|------------------|---------------------|
| COARSE | Crushed Stone | 2.65 | 1.0% |
| FINE | Sand | 2.62 | 3.0% |

| ADMIXTURE | DOSAGE RATE | Cement Scale | 6000 lbs. MAX |
|---------------|------------------|-----------------|-----------------|
| Air Entrainer | 0.60 oz/bag | Aggregate Scale | 25,000 lbs. MAX |
| Water Reducer | 2.50 oz/100 lbs. | | |

| Water | |
|----------------------|--|
| First Site Addition | Enough to increase the slump by 2 inches |
| Second Site Addition | |

** Remember that we need the Type of coarse aggregate so we can get the correct w/c ratio from the Structural Concrete Table **



BATCH TICKET PRINTOUT OR BATCH COMPUTER SCREEN

STEP 2. Find the appropriate batch ticket paying attention to class and additional cementitious materials.

| | | | | | | |
|---------------------------|----------------------------|-------------------------------|---|---------------------------|----------------------------|---------------------------|
| TRUCK # 98 | FILE # 34.017 | USER D. Taylor | DISPATCH TICKET NUMBER 654984 | TICKET ID 20907 | BATCH TIME 12:06 | DATE 10/31/2016 |
| LOAD SIZE 10.00 | MIX CODE 3000AEF | RETURNED QUANTITY 0 | CUMMULATIVE YARDS 20 Y | | | |
| MATERIAL | DESIGN QTY (SSD/YD) | TARGET WEIGHT | BATCHED | % Var | % Moisture | |
| Coarse Agg | 2158 lb | 21800 lb | 22197 lb | 1.02 | 1.00% | |
| Int Agg | | | | | 0.00% | |
| Fine Agg | 1070 lb | 11020 lb | 11130 lb | 1.00 | 3.00% | |
| Total Agg (lbs) | | | | | | |
| Cement | 553 lb | 5530 lb | 5535 lb | 1.00 | | |
| Fly Ash | 42 lb | 420 lb | 431 lb | 1.03 | | |
| WR | 2.5 oz/ 100 Lbs. | 149 oz | 149 oz | | | |
| Air | 0.6 oz/bag | 38 oz | 38 oz | | | |
| Water (lbs) | 274 lb | 2199 lb | | | | |
| Water (gal) | | 264 gal | 235 gal | | | |



FILE NO: _____ DATE: _____ CLASS _____ LOAD NO. _____ CU YDS _____ ACC. CY _____ TRUCK # _____
 TIME MIXING BEGAN: _____ REV. @ PLANT, @ MIXING SPEED _____ PLANT AND LOCATION _____
 PLANT INSPECTOR: _____ MAX. WATER ALLOWED FOR THE MIX _____

| MATERIALS | * BATCH CHART TOTAL WEIGHT | TOLERANCE | * BATCH CHART TOTAL WEIGHT RANGE | | IF SINGLE OR DOUBLE BATCHED | | IF SINGLE BATCHED OR SUM OF DBL BATCH | MEETS BATCH CHART RANGE | | * FREE MOISTURE PERCENT | SSD WEIGHT ACTUAL * BATCH WEIGHT DIVIDED BY (1+%Moist.) | TOTAL LBS WATER IN LOAD |
|--------------------------|----------------------------|-----------|----------------------------------|--------|------------------------------|---------------------|---------------------------------------|-------------------------|----|-------------------------|---|--|
| | | | LOW - | HIGH + | ACTUAL BATCH WEIGHT (single) | ACTUAL BATCH WEIGHT | | YES | NO | | | |
| CEMENT, LBS. | | -1% | | | | | | | | | | |
| FLY ASH, LBS. | | -1% | | | | | | | | | | |
| SILICA FUME, LBS. | | -1% | | | | | | | | | | |
| TOTAL CEM. MATL. | | -1% | | | | | | | | | | FREE AGG. MOISTURE = ACT. BATCH WT. MINUS SSD WEIGHT |
| AGGREGATE (1) LBS | | +2% | | | | | | | | | | |
| AGGREGATE (2) LBS | | +2% | | | | | | | | | | |
| AGGREGATE (3) LBS | | +2% | | | | | | | | | | |
| TOTAL (1) + (2) + (3) | | --- | | | | | | | | | | |
| CRR, INHIB., GAL | | --- | | | | | | | | 32 oz / GAL | (DCI ONLY) | |
| METER WATER GAL | | | | | | | | | | | TRUCK WASH WATER | |
| METER WATER LBS | | | | | | | | | | | METER WATER LBS. _____ = _____ | |
| AIR ENT. AGENT, oz | | | | | | | | | | | Max. Water Allowed for Site Additions | |
| WATER RED. AGENT, oz | | | | | | | | | | | GAL. _____ LBS. _____ | |
| WATER RED/RETARDED, oz | | | | | | | | | | | TOTAL WATER AT PLANT = _____ | |
| MR/HR WATER RED. RET. oz | | | | | | | | | | | | |

CALCULATION OF WATER/CEMENTITIOUS MATERIAL RATIO:

RATIO = TOTAL WATER IN LOAD (LBS) = _____
 TOTAL CEM. MATL. (LBS) = _____ = _____

COMMENTS: _____
 SLUMP: _____ ENTR. AIR %: _____
 CYLINDERS MADE (NO / YES): _____ ID #: _____
 TIME UNLOADING OF TRUCK ENDED: _____
 POUR LOCATION: _____
 FIELD INSPECTOR: _____
 MIXING REV. AT SITE: _____ TOTAL oz: _____ REV. AFTER SITE WATER ADDED _____
 ADMIXTURE ADDED AT SITE: _____ oz / 100 LBS
 MIXING TIME AFTER ADDING ADMIXTURE: _____ MINUTES
 CONCRETE TEMPERATURE @ PLACEMENT: _____ DEG. F

*FILL IN FOR 1st LOADS EACH DAY - THEN ONLY IF THERE IS A CHANGE.
 **ADD 1.00 TO MOISTURE % (DECIMAL FORM)

Mix Information As Batched

| | | | | | | |
|---------------------------|----------------------------|-------------------------------|---|---------------------------|----------------------------|---------------------------|
| TRUCK # 98 | FILE # 34.017 | USER D. Taylor | DISPATCH TICKET NUMBER 654984 | TICKET ID 20907 | BATCH TIME 12:06 | DATE 10/31/2016 |
| LOAD SIZE 10.00 | MIX CODE 3000AEF | RETURNED QUANTITY 0 | CUMMULATIVE YARDS 20 Y | | | |
| MATERIAL | DESIGN QTY (SSD/YD) | TARGET WEIGHT | BATCHED | % Var | % Moisture | |
| Coarse Agg | 2158 lb | 21800 lb | 22197 lb | 1.02 | 1.00% | |
| Int Agg | | | | | 0.00% | |
| Fine Agg | 1070 lb | 11020 lb | 11130 lb | 1.00 | 3.00% | |
| Total Agg (lbs) | | | | | | |
| Cement | 553 lb | 5530 lb | 5535 lb | 1.00 | | |
| Fly Ash | 42 lb | 420 lb | 431 lb | 1.03 | | |
| WR | 2.5 oz/ 100 Lbs. | 149 oz | 149 oz | | | |
| Air | 0.6 oz/bag | 38 oz | 38 oz | | | |
| Water (lbs) | 274 lb | 2199 lb | | | | |
| Water (gal) | | 264 gal | 235 gal | | | |

You must always verify that the SSD Material Weights are the same SSD weights used on the SCDOT Reviewed Mix Design from the OMR. A copy of the SCDOT Approved Mix Design can be obtained from the RCE or the Ready Mix Concrete Plant will have access to the approved design.



Mix Information As Batched

| | | | | | | |
|---------------------------|----------------------------|-------------------------------|---|---------------------------|----------------------------|---------------------------|
| TRUCK # 98 | FILE # 34.017 | USER D. Taylor | DISPATCH TICKET NUMBER 654984 | TICKET ID 20907 | BATCH TIME 12:06 | DATE 10/31/2016 |
| LOAD SIZE 10.00 | MIX CODE 3000AEF | RETURNED QUANTITY 0 | CUMMULATIVE YARDS 20 Y | | | |
| MATERIAL | DESIGN QTY (SSD/YD) | TARGET WEIGHT | BATCHED | % Var | % Moisture | |
| Coarse Agg | 2158 lb | 21800 lb | 22197 lb | 1.02 | 1.00% | |
| Int Agg | | | | | 0.00% | |
| Fine Agg | 1070 lb | 11020 lb | 11130 lb | 1.00 | 3.00% | |
| Total Agg (lbs) | | | | | | |
| Cement | 553 lb | 5530 lb | 5535 lb | 1.00 | | |
| Fly Ash | 42 lb | 420 lb | 431 lb | 1.03 | | |
| WR | 2.5 oz/ 100 Lbs. | 149 oz | 149 oz | | | |
| Air | 0.6 oz/bag | 38 oz | 38 oz | | | |
| Water (lbs) | 274 lb | 2199 lb | | | | |
| Water (gal) | | 264 gal | 235 gal | | | |

You must also verify that the materials used are from the source that were used on the approved mix design and that they are approved on the current QPL.



STEP 3. Fill in basic batch information at the top of the form.

This includes the:

| |
|------------------------------|
| File Number |
| Date |
| Class of Concrete |
| Load Number |
| Load Size |
| Accumulated Load Size |
| Truck Number |

(= Load number x Load Size)

| | | |
|--------------------------------|--|---------------------------|
| FORM 700.04 REVISED (08/12) | SOUTH CAROLINA DEPARTMENT OF TRANSPORTATION READY MIX CONCRETE REPORT | |
| FILE NO: _____ | DATE: _____ | CLASS: _____ |
| TIME MIXING BEGAN: _____ | REV. @ PLANT, @ MIXING SPEED: _____ | LOAD NO: _____ |
| PLANT INSPECTOR: _____ | MAX. WATER ALLOWED FOR THE MIX: _____ | CU YDS: _____ |
| | | ACC. CY: _____ |
| | | TRUCK # _____ |
| | | PLANT AND LOCATION: _____ |

Top Portion of 700.04 Form



STEP 3. Fill in basic batch information at the top of the form.

This includes the:

| |
|------------------------------|
| File Number |
| Date |
| Class of Concrete |
| Load Number |
| Load Size |
| Accumulated Load Size |
| Truck Number |

(= Load number x Load Size)

| | | | | |
|------------------------------------|--|---|----------------------------|--|
| Form 700.04 | South Carolina Department Of Transportation Ready Mix Concrete Report | | | |
| File No. 34.017 | Date: 10/31/16 | Class: 3000 | Load No. 2 | Cu Yds 10 Accumulative CY 20 Truck # 98 |
| Time Mixing Began _____ | (Time) _____ | Revs @ Plant, @ Mixing Speed _____ | (Revolutions) _____ | Plant and Location _____ |
| Plant Inspector John Q. Doe | | | | |

Top Portion of 700.04 Form



STEP 4-8. The Batch Total Weights are given on the appropriate concrete plant batch ticket or the screen of the computer of the batch system. These are the **theoretically ideal values** for proportioning this specific class of concrete using the prescribed materials.

SOUTH CAROLINA DEPARTMENT OF TRANSPORTATION
READY MIX CONCRETE REPORT

FILE NO: _____ DATE: _____ REV. @ PLANT, @ MIXING SPEED _____ CLASS _____ LOAD NO. _____ CU YDS _____ ACC. CY. _____ TRUCK # _____

TIME MIXING BEGAN: _____ PLANT AND LOCATION: _____

PLANT INSPECTOR: _____ MAX. WATER ALLOWED FOR THE MIX _____

| MATERIALS | BATCH CHART TOTAL WEIGHT | TOLERANCE | | BATCH CHART TOTAL WEIGHT RANGE | | IF SINGLE OR DOUBLE BATCHED | | IF SINGLE BATCHED OR SUM OF DBL BATCH | | MEETS BATCH CHART RANGE | | FREE MOISTURE PERCENT | SSD WEIGHT ACTUAL* BATCH WEIGHT DIVIDED BY (1+%Moist) | TOTAL LBS WATER IN LOAD |
|-------------------------|--------------------------|-----------|---|--------------------------------|------|------------------------------|---------------------|---------------------------------------|----|-------------------------|----|-----------------------|---|-------------------------|
| | | ± | ± | LOW | HIGH | ACTUAL BATCH WEIGHT (single) | ACTUAL BATCH WEIGHT | ACTUAL BATCH WEIGHT | NO | YES | NO | | | |
| CEMENT, LBS. | | -1% | | | | | | | | | | | | |
| FLY ASH, LBS. | | -1% | | | | | | | | | | | | |
| SILICA FUME, LBS. | | -1% | | | | | | | | | | | | |
| TOTAL CEM. MATL. | | -1% | | | | | | | | | | | | |
| AGGREGATE (1) LBS. | | +2% | | | | | | | | | | | | |
| AGGREGATE (2) LBS. | | +2% | | | | | | | | | | | | |
| AGGREGATE (3) LBS. | | +2% | | | | | | | | | | | | |
| TOTAL (1) + (2) + (3) | | | | | | | | | | | | | | |
| PRR. INHIB., GAL. | | | | | | | | | | | | | | |
| METER WATER GAL | | | | | | | | | | | | | | |
| METER WATER LBS | | | | | | | | | | | | | | |
| AIR ENT. AGENT, oz | | | | | | | | | | | | | | |
| WATER RED. AGENT, oz | | | | | | | | | | | | | | |
| WATER RED/RET. AGED, oz | | | | | | | | | | | | | | |
| PRR. WATER RED. RET. oz | | | | | | | | | | | | | | |

TRUCK WASH WATER: _____ GAL. X 8.33 = _____

METER WATER LBS: _____ = _____

Max. Water Allowed for Site Additions: _____ LBS.

TOTAL WATER AT PLANT = _____

1st WATER ADDED AT SITE: _____ GAL. X 8.33 = LBS.

2nd WATER ADDED AT SITE: _____ GAL. X 8.33 = LBS.

TOTAL WATER IN LOAD = (SUM) _____ LBS.

CALCULATION OF WATER/CEMENTITIOUS MATERIAL RATIO:
RATIO = TOTAL WATER IN LOAD (LBS) / TOTAL CEM. MATL. (LBS) = _____ = _____

COMMENTS: _____

SLUMP: _____ ENTR. AIR %: _____

CYLINDERS MADE (NO/YES): _____ ID #: _____

TIME UNLOADING OF TRUCK ENDED: _____

POUR LOCATION: _____

FIELD INSPECTOR: _____

MIXING REV. AT SITE: _____ TOTAL oz _____ REV. AFTER SITE WATER ADDED _____

ADMIXTURE ADDED AT SITE: _____ TOTAL oz _____

MIXING TIME AFTER ADDING ADMIXTURE: _____ MINUTES _____

CONCRETE TEMPERATURE @ PLACEMENT: _____ DEG. F _____

*FILL IN FOR 1st LOADS EACH DAY - THEN ONLY IF THERE IS A CHANGE

**ADD 1.00 TO MOISTURE % (DECIMAL FORM)



Mix Information As Batched

| | | | | | | |
|---------------------------|----------------------------|-------------------------------|---|---------------------------|----------------------------|---------------------------|
| TRUCK # 98 | FILE # 34.017 | USER D. Taylor | DISPATCH TICKET NUMBER 654984 | TICKET ID 20907 | BATCH TIME 12:06 | DATE 10/31/2016 |
| LOAD SIZE 10.00 | MIX CODE 3000AEF | RETURNED QUANTITY 0 | CUMMULATIVE YARDS 20 Y | | | |
| MATERIAL | DESIGN QTY (SSD/YD) | TARGET WEIGHT | BATCHED | % Var | % Moisture | |
| Coarse Agg | 2158 lb | 21800 lb | 22197 lb | 1.02 | 1.00% | |
| Int Agg | | | | | 0.00% | |
| Fine Agg | 1070 lb | 11020 lb | 11130 lb | 1.00 | 3.00% | |
| Total Agg (lbs) | | | | | | |
| Cement | 553 lb | 5530 lb | 5535 lb | 1.00 | | |
| Fly Ash | 42 lb | 420 lb | 431 lb | 1.03 | | |
| WR | 2.5 oz/ 100 Lbs. | 149 oz | 149 oz | | | |
| Air | 0.6 oz/bag | 38 oz | 38 oz | | | |
| Water (lbs) | 274 lb | 2199 lb | | | | |
| Water (gal) | | 264 gal | 235 gal | | | |

The Target Weight is the theoretical weight of the materials that have been adjusted for moisture content for the given size load of concrete.



STEP 4-8. The Theoretical Batch Total Weights can be obtained from the Batch Ticket or Batch Computer Screen. These are the theoretically ideal values for proportioning this specific class of concrete using the prescribed materials.

| | | | |
|----------------------|---------------------------|----------------------------|---|
| TRUCK # 98 | FILE # 34.017 | USER D. Taylor | DISPATCH TICKET NUMBER 654984 |
| | LOAD SIZE 10.00 | MIX CODE 3000AEF | RETURNED QUANTITY 0 |

| | | |
|---------------------------|----------------------------|-------------------------------|
| LOAD SIZE 10.00 | MIX CODE 3000AEF | RETURNED QUANTITY 0 |
|---------------------------|----------------------------|-------------------------------|

| MATERIAL | DESIGN QTY (SSD/YD) | TARGET WEIGHT |
|-----------------|---------------------|---------------|
| Coarse Agg | 2158 lb | 21800 lb |
| Int Agg | | |
| Fine Agg | 1070 lb | 11020 lb |
| Total Agg (lbs) | | |
| Cement | 553 lb | 5530 lb |
| Fly Ash | 42 lb | 420 lb |
| WR | 2.5 oz/ 100 Lbs. | 149 oz |
| Air | 0.6 oz/bag | 38 oz |
| Water (lbs) | 274 lb | 2199 lb |
| Water (gal) | | 264 gal |

| MATERIALS | * BATCH CHART TOTAL |
|---------------------------------|---------------------|
| CEMENT LBS. | 5530 |
| FLY ASH LBS. | 420 |
| SILICA FUME LBS. | |
| TOTAL CEM. MATERIAL | "5950" |
| AGGREGATE (1) LBS. | 21800 |
| AGGREGATE (2) LBS. | 11020 |
| AGGREGATE (3) LBS. | |
| TOTAL (1) + (2) + (3) | "32820" |
| METER WATER GAL (= GAL x 8.33) | 264 |
| METER WATER LBS | 2199 |

700.04 Form

Batch Ticket



STEP 9. Calculate the allowable weight tolerances as indicated. Round the weights to the nearest pound.

$$5530 - (.01 \times 5530) = \mathbf{5475}$$

$$5530 \times .99 = \mathbf{5475}$$

$$420 \times .99 = \mathbf{416}$$

$$5950 \times .99 = \mathbf{5891}$$

$$21800 - (.02 \times 21800) = \mathbf{21364}$$

$$21800 + (.02 \times 21800) = \mathbf{22236}$$

$$11020 \times 0.98 = \mathbf{10800}$$

$$11020 \times 1.02 = \mathbf{11240}$$

There are multiple methods to calculate the low and high values used to bracket the acceptable tolerance. You may use any method you are comfortable with. Two different methods are show above.

| MATERIALS | * BATCH CHART TOTAL | TOLERLANCE | * Batch Chart Total | |
|-----------------------|---------------------|------------|---------------------|--------------|
| | | | Low - | High + |
| CEMENT LBS. | 5530 | -1% | 5475 | XXXXX |
| FLY ASH LBS. | 420 | -1% | 416 | XXXXX |
| SILICA FUME LBS. | | -1% | | XXXXX |
| TOTAL CEM. MATL. | 5950 | -1% | 5891 | XXXXX |
| AGGREGATE (1) LBS. | 21800 | ±2% | 21364 | 22236 |
| AGGREGATE (2) LBS. | 11020 | ±2% | 10800 | 11240 |
| AGGREGATE (3) LBS. | | ±2% | | |
| TOTAL (1) + (2) + (3) | 32820 | --- | | |
| COR. INHIBITOR GAL | | --- | | |
| METER WATER GAL | 264 | | * Rate | |
| METER WATER LBS. | 2199 | | oz/Bag | oz/100 lbs |

700.04 Form



STEP 10-11. Obtain the loading/dosage rates for any admixtures to be incorporated into the batch from the problem statement. For this example, the AEA loads at 0.6 oz/bag of cementitious material. Since a bag of cement weighs 94 lbs., the loads rate could be written 0.6 oz/94 lbs. Notice that WRA's and WRR's dose per 100 lbs. cementitious material. For this example, the WRA loads at 2.5 oz/ 100 lbs. of cementitious material.

| MATERIALS | * BATCH CHART TOTAL | TOLERLANCE |
|-----------------------|---------------------|------------|
| CEMENT LBS. | 5530 | -1% |
| FLY ASH LBS. | 420 | -1% |
| SILICA FUME LBS. | | -1% |
| TOTAL CEM. MATL. | 5950 | -1% |
| AGGREGATE (1) LBS. | 21800 | ±2% |
| AGGREGATE (2) LBS. | 11020 | ±2% |
| AGGREGATE (3) LBS. | | ±2% |
| TOTAL (1) + (2) + (3) | 32820 | --- |
| COR. INHIBITOR GAL | | --- |
| METER WATER GAL | 264 | |
| METER WATER LBS. | 2199 | |
| AIR ENT. AGENT | 38 | |
| WATER RED. AGENT | 149 | |
| WATER RED/RETARDER | | |

To calculate the amount of AEA to the nearest oz:

$$(0.60/94) \times 5950 = 38 \text{ oz}$$

OR

$$(5950/94) \times 0.60 = 38 \text{ oz}$$

To calculate the amount of WRA to the nearest oz:

$$(2.50/100) \times 5950 = 149 \text{ oz}$$

OR

$$(5950/100) \times 2.5 = 149 \text{ oz}$$

| * Rate | |
|--------|------------|
| oz/Bag | oz/100 lbs |
| 0.6 | XXXXX |
| XXXX | 2.5 |
| XXXX | |



STEP 12. Using the batch ticket values (**actual proportions that are in the truck or central mixer**), fill in the Actual Batch Weight values. Verify that a double batch was/was not required.

| TRUCK # 98 | FILE # 34.017 | USER D. Taylor | DISPATCH TICKET NUMBER 654984 | TICKET ID 20907 | BATCH TIME 12:06 | DATE 10/31/2016 |
|--------------------|---------------------|------------------------|-------------------------------------|--------------------|---------------------|--------------------|
| LOAD SIZE 10.00 | MIX CODE 3000AEF | RETURNED QUANTITY 0 | CUMMULATIVE YARDS 20 Y | | | |
| MATERIAL | DESIGN QTY (SSD/YD) | TARGET WEIGHT | BATCHED | % Var | % Moisture | |
| Coarse Agg | 2158 lb | 21800 lb | 22197 lb | 1.02 | 1.00% | |
| Int Agg | | | | | 0.00% | |
| Fine Agg | 1070 lb | 11020 lb | 11130 lb | 1.00 | 3.00% | |
| Total Agg (lbs) | | | | | | |
| Cement | 553 lb | 5530 lb | 5535 lb | 1.00 | | |
| Fly Ash | 42 lb | 420 lb | 431 lb | 1.03 | | |
| WR | 2.5 oz/ 100 Lbs. | 149 oz | 149 oz | | | |
| Air | 0.6 oz/bag | 38 oz | 38 oz | | | |
| Water (lbs) | 274 lb | 2199 lb | | | | |
| Water (gal) | | 264 gal | 235 gal | | | |



STEP 12. Using the batch ticket values (actual proportions that are in the truck or central mixer), fill in the Actual Batch Weight values. Verify that a double batch was/was not required.

| | |
|------------------------|-----------|
| DISPATCH TICKET NUMBER | TICKET ID |
| 654984 | 20907 |

| | |
|-------------------|-------------------|
| RETURNED QUANTITY | CUMMULATIVE YARDS |
| 0 | 20 Y |

| | |
|---------------|----------|
| TARGET WEIGHT | BATCHED |
| 21800 lb | 22197 lb |
| 11020 lb | 11130 lb |
| 5530 lb | 5535 lb |
| 420 lb | 431 lb |
| 149 oz | 149 oz |
| 38 oz | 38 oz |
| 2199 lb | |
| 264 gal | 235 gal |

| MATERIALS | BATCH CHART TOTAL WEIGHT | TOLERANCE | BATCH CHART TOTAL WEIGHT RANGE | | IF SINGLE OR DOUBLE BATCHED | | IF SINGLE BATCHED OR SUM OF DBL BATCH | MEETS BATCH CHART RANGE | |
|--------------------------|--------------------------|-----------|--------------------------------|-------|------------------------------|---------------------|---------------------------------------|-------------------------|--------------------|
| | | | LOW | HIGH | ACTUAL BATCH WEIGHT (single) | ACTUAL BATCH WEIGHT | | YES | NO |
| CEMENT, LBS. | 5530 | -1% | 5475 | | | | 5535 | | |
| FLY ASH, LBS. | 420 | -1% | 416 | | | | 431 | | |
| SILICA FUME, LBS. | | -1% | | | | | | | |
| TOTAL CEM. MATL. | 5950 | -1% | 5891 | | | | | | |
| AGGREGATE (1) LBS | 21800 | +2% | 21364 | 22236 | | | 22197 | | |
| AGGREGATE (2) LBS | 11202 | +2% | 10800 | 11240 | | | 11130 | | |
| AGGREGATE (3) LBS | | +2% | | | | | | | |
| TOTAL (1) + (2) + (3) | 32820 | | | | | | | | |
| CRR. INHIB., GAL | | | | | | | | | |
| METER WATER GAL | 264 | | | | | | | | TRUCK WASH WATER |
| METER WATER LBS | 2199 | oz/BAG | | | | | | | METER WATER LBS. — |
| AIR ENT. AGENT, oz | 38 | 0.60 | | | | | | | Max. Water Allow |
| WATER RED. AGENT, oz | 149 | | | 2.5 | | | | | GAL |
| WATER RED/RETARDED, oz | | | | | | | | | |
| MIR/HR WATER RED/RET, oz | | | | | | | | | TOTAL WATER |

Batch Ticket

700.04 Form



STEP 13. To determine the total cementitious material quantity, add the cement, and fly ash weights. Place this value in the appropriate space.

$$5535 + 431 = 5966$$

| MATERIALS | BATCH CHART TOTAL WEIGHT | TOLERANCE | BATCH CHART TOTAL WEIGHT RANGE | | IF SINGLE OR DOUBLE BATCHED | | IF SINGLE BATCHED OR SUM OF DBL BATCH | MEETS BATCH REQUIREMENT |
|-------------------------|--------------------------|-----------|--------------------------------|--------------|------------------------------|---------------------|---------------------------------------|-------------------------|
| | | | LOW - | HIGH + | ACTUAL BATCH WEIGHT (single) | ACTUAL BATCH WEIGHT | | |
| CEMENT, LBS. | 5530 | -1% | 5475 | | | | 5535 | YES |
| FLY ASH, LBS. | 420 | -1% | 416 | | | | 431 | |
| SILICA FUME, LBS. | | -1% | | | | | | |
| TOTAL CEM. MATL. | 5950 | -1% | 5891 | | | | 5966 | |
| AGGREGATE (1) LBS | 21800 | +2% | 21364 | 22236 | | | 22197 | |
| AGGREGATE (2) LBS | 11020 | +2% | 10800 | 11240 | | | 11130 | |
| AGGREGATE (3) LBS | | +2% | | | | | | |
| TOTAL (1) + (2) + (3) | 32820 | | | | | | | |
| CRR. INHIB., GAL | | | | | | | | |
| METER WATER GAL | 264 | | | | | | | TRUCK WA |
| METER WATER LBS | 2199 | oz / BAG | | oz / 100 LBS | | | | METER |
| AIR ENT. AGENT, oz | 38 | 0.60 | | | | | | Max |
| WATER RED. AGENT, oz | 149 | | | 2.5 | | | | GAL. |
| WATER RED/RETARDED, oz | | | | | | | | |
| MFR. WATER RED. RET. oz | | | | | | | | |



700.04 Form

STEP 14. From the batch ticket obtain the actual batched water in gallons from the “Batched” column.

* Some plants weigh water and it will already be given in pounds.

| MATERIALS | BATCH CHART TOTAL WEIGHT | TOLERANCE | BATCH CHART TOTAL WEIGHT RANGE | | IF SINGLE OR DOUBLE BATCHED | | IF SINGLE BATCHED OR SUM OF DBL BATCH | MEETS BATCH |
|------------------------|--------------------------|-----------|--------------------------------|--------------|------------------------------|---------------------|---------------------------------------|-------------|
| | | | LOW - | HIGH + | ACTUAL BATCH WEIGHT (single) | ACTUAL BATCH WEIGHT | | |
| | | | | | | | | |
| CEMENT, LBS. | 5530 | -1% | 5475 | | | | 5535 | YES |
| FLY ASH, LBS. | 420 | -1% | 416 | | | | 431 | |
| SILICA FUME, LBS. | | -1% | | | | | | |
| TOTAL CEM. MATL. | 5950 | -1% | 5891 | | | | 5966 | |
| AGGREGATE (1) LBS | 21800 | +2% | 21364 | 22236 | | | 22197 | |
| AGGREGATE (2) LBS | 11020 | +2% | 10800 | 11240 | | | 11130 | |
| AGGREGATE (3) LBS | | +2% | | | | | | |
| TOTAL (1) + (2) + (3) | 32820 | | | | | | | |
| CRR. INHIB., GAL | | | | | | | | |
| METER WATER GAL | 264 | | | | | | 235 | TRUCK WA |
| METER WATER LBS | 2199 | | oz / BAG | oz / 100 LBS | | | | METER 1 |
| AIR ENT. AGENT, oz | 38 | | 0.60 | | | | | Max |
| WATER RED. AGENT, oz | 149 | | | 2.5 | | | | GAL. |
| WATER RED/RETARDED, oz | | | | | | | | |
| MR/HR WATER RED.RET.oz | | | | | | | | |



700.04 Form



STEP 14. If the batch ticket does not give the weight of water in pounds, take the number of gallons and multiply by 8.33 to get the pounds to the nearest whole number. $235 \times 8.33 = 1958$

| MATERIALS | * BATCH CHART TOTAL WEIGHT | TOLERANCE | * BATCH CHART TOTAL WEIGHT RANGE | | IF SINGLE OR DOUBLE BATCHED | | IF SINGLE BATCHED OR SUM OF DBL BATCH ACTUAL BATCH WEIGHT | MEETS BAT RAN |
|------------------------|----------------------------------|-----------|--|--------------|---------------------------------------|---------------------------|---|------------------|
| | | | LOW - | HIGH + | ACTUAL BATCH WEIGHT (single) | ACTUAL BATCH WEIGHT | | |
| CEMENT, LBS. | 5530 | -1% | 5475 | | | | 5535 | YES |
| FLY ASH, LBS. | 420 | -1% | 416 | | | | 431 | |
| SILICA FUME, LBS. | | -1% | | | | | | |
| TOTAL CEM. MATL. | 5950 | -1% | 5891 | | | | 5966 | |
| AGGREGATE (1) LBS | 21800 | +2% | 21364 | 22236 | | | 22197 | |
| AGGREGATE (2) LBS | 11020 | +2% | 10800 | 11240 | | | 11130 | |
| AGGREGATE (3) LBS | | +2% | | | | | | |
| TOTAL (1) + (2) + (3) | 32820 | — | | | | | | |
| CRR. INHIB., GAL | | — | | | | | | |
| METER WATER GAL | 264 | | | | *RATE | | 235 | TRUCK WA |
| METER WATER LBS | 2199 | oz / BAG | | oz / 100 LBS | | | 1958 | METER |
| AIR ENT. AGENT. oz | 38 | 0.60 | | | | | | Max |
| WATER RED. AGENT. oz | 149 | | | 2.5 | | | | GAL |
| WATER RED/RETARDED, oz | | | | | | | | |
| MRWR WATER RED.RET.oz | | | | | | | | |

700.04 Form



STEP 15. Evaluate the actual batch weights to determine if they meet the acceptable “Theoretical Batch Values”. Place a mark in the corresponding YES box for proportions that are within the acceptable range. Place a mark in the NO box for proportions that are outside of the acceptable range.

| MATERIALS | BATCH CHART TOTAL WEIGHT | TOLERANCE | BATCH CHART TOTAL WEIGHT RANGE | | IF SINGLE OR DOUBLE BATCHED | | IF SINGLE BATCHED OR SUM OF DBL BATCH | | MEETS BATCH CHART RANGE | |
|--------------------------|--------------------------|-----------|--------------------------------|--------|------------------------------|---------------------|---------------------------------------|---------------------|-------------------------|--------------------|
| | | | LOW - | HIGH + | ACTUAL BATCH WEIGHT (single) | ACTUAL BATCH WEIGHT | ACTUAL BATCH WEIGHT | ACTUAL BATCH WEIGHT | YES | NO |
| | | | | | | | | | | |
| CEMENT, LBS. | 5530 | -1% | 5475 | | | | 5535 | | X | |
| FLY ASH, LBS. | 420 | -1% | 416 | | | | 431 | | X | |
| SILICA FUME, LBS. | | -1% | | | | | | | | |
| TOTAL CEM. MATL. | 5950 | -1% | 5891 | | | | 5966 | | X | |
| AGGREGATE (1) LBS | 21800 | +2% | 21364 | 22236 | | | 22197 | | X | |
| AGGREGATE (2) LBS | 11020 | +2% | 10800 | 11240 | | | 11130 | | X | |
| AGGREGATE (3) LBS | | +2% | | | | | | | | |
| TOTAL (1) + (2) + (3) | 32820 | | | | | | | | | |
| CRR, INHIB., GAL | | | | | | | | | | |
| METER WATER GAL | 264 | | | | | | 235 | | | TRUCK WASH WATER |
| METER WATER LBS | 2199 | oz / BAG | | | | | 1958 | | | METER WATER LBS. — |
| AIR ENT. AGENT, oz | 38 | 0.60 | | | | | | | | Max. Water Allow |
| WATER RED. AGENT, oz | 149 | | | 2.5 | | | | | | GAL. |
| WATER RED/RETARDED, oz | | | | | | | | | | |
| MIR/HR WATER RED./RET.OZ | | | | | | | | | | TOTAL WATER |

In this example, 5966 lbs cement exceeds the minimum acceptable value of 5475 lb, so the cement weight meets the tolerance. 22197 lbs of crushed stone falls between the acceptable low of 21364 lbs and the acceptable high of 22236, so the coarse aggregate meets tolerance.



STEP 16a. Fill in the “Free Moisture Percent” spaces with the appropriate values.

The values for the aggregate moistures are obtained from the Batch Ticket or Batch Computer Screen.

| IF SINGLE BATCHED OR SUM OF DBL BATCH | MEETS BATCH CHART RANGE | | FREE MOISTURE PERCENT | SSD WEIGHT ACTUAL ** BATCH WEIGHT DIVIDED BY (1+%Moist.) | TOTAL LBS WATER IN LOAD |
|---------------------------------------|---------------------------------------|----|-----------------------|--|--|
| | YES | NO | | | |
| ACTUAL BATCH WEIGHT | | | | | |
| 5535 | | | | | FREE AGG. MOISTURE = ACT. BATCH WT. MINUS SSD WEIGHT |
| 431 | | | | | |
| 5966 | | | | | |
| 22197 | | | | | |
| 11130 | | | | | |
| | | | | | |
| | | | | | |
| 235 | | | 32 oz / GAL | (DCI ONLY) | |
| | TRUCK WASH WATER | | | GAL X 8.33 = | |
| | METER WATER LBS. _____ = | | | | |
| | Max. Water Allowed for Site Additions | | | | |
| | GAL. _____ | | LBS. _____ | | |
| | TOTAL WATER AT PLANT = | | | | |
| | | | | | |
| | | | | | |
| 1st WATER ADDED AT SITE | | | | GAL x 8.33 = LBS. | |
| 2nd WATER ADDED AT SITE | | | | GAL x 8.33 = LBS. | |
| TOTAL WATER IN LOAD = (SUM) | | | | _____ LBS. | |



700.04 Form



Mix Information As Batched

| | | | | | | |
|---------------------------|----------------------------|-------------------------------|---|---------------------------|----------------------------|---------------------------|
| TRUCK # 98 | FILE # 34.017 | USER D. Taylor | DISPATCH TICKET NUMBER 654984 | TICKET ID 20907 | BATCH TIME 12:06 | DATE 10/31/2016 |
| LOAD SIZE 10.00 | MIX CODE 3000AEF | RETURNED QUANTITY 0 | CUMMULATIVE YARDS 20 Y | | | |
| MATERIAL | DESIGN QTY (SSD/YD) | TARGET WEIGHT | BATCHED | % Var | % Moisture | |
| Coarse Agg | 2158 lb | 21800 lb | 22197 lb | 1.02 | 1.00% | |
| Int Agg | | | | | 0.00% | |
| Fine Agg | 1070 lb | 11020 lb | 11130 lb | 1.00 | 3.00% | |
| Total Agg (lbs) | | | | | | |
| Cement | 553 lb | 5530 lb | 5535 lb | 1.00 | | |
| Fly Ash | 42 lb | 420 lb | 431 lb | 1.03 | | |
| WR | 2.5 oz/ 100 Lbs. | 149 oz | 149 oz | | | |
| Air | 0.6 oz/bag | 38 oz | 38 oz | | | |
| Water (lbs) | 274 lb | 2199 lb | | | | |
| Water (gal) | | 264 gal | 235 gal | | | |



STEP 16a. Fill in the “Free Moisture Percent” spaces with the appropriate values.

| | | |
|----------------------------------|----------------------------|---------------------------|
| TICKET ID 20907 | BATCH TIME 12:06 | DATE 10/31/2016 |
| CUMMULATIVE YARDS 20 Y | | |
| BATCHED | % Var | % Moisture |
| 22197 lb | 1.02 | 1.00% |
| 11130 lb | 1.00 | 0.00% |
| 5535 lb | 1.00 | |
| 431 lb | 1.03 | |
| 149 oz | | |
| 38 oz | | |
| 235 gal | | |

For this example, the coarse aggregate moisture is 1.00% which corresponds to **0.01** as a decimal. The fine aggregate moisture is 3% or **0.03**.



| | | | | | |
|---------------------------------------|---------------------------------------|----|------------------------|---|--|
| IF SINGLE BATCHED OR SUM OF DBL BATCH | MEETS BATCH CHART RANGE | | FREE MOISTURE PERCENT | SSD WEIGHT ACTUAL * BATCH WEIGHT DIVIDED BY (1+*Moist.) | TOTAL LBS WATER IN LOAD |
| | YES | NO | | | |
| ACTUAL BATCH WEIGHT | | | | | |
| 5535 | | | | | |
| 431 | | | | | FREE AGG. MOISTURE = ACT. BATCH WT. MINUS SSD WEIGHT |
| 5966 | | | | | |
| 22197 | | | 0.01 | | |
| 11130 | | | 0.03 | | |
| | | | | | |
| | | | | | |
| 235 | | | | | |
| | TRUCK WASH WATER | | 32 oz / GAL (DCI ONLY) | | |
| | METER WATER LBS. _____ = | | | | |
| | Max. Water Allowed for Site Additions | | | | |
| | GAL. _____ LBS. _____ | | | | |
| | TOTAL WATER AT PLANT = | | | | |
| | | | | | |
| 1st WATER ADDED AT SITE | | | | GAL x 8.33 = LBS. | |
| 2nd WATER ADDED AT SITE | | | | GAL x 8.33 = LBS. | |
| TOTAL WATER IN LOAD = (SUM) | | | | _____ LBS. | |

700.04 Form



STEP 16b. Calculate the “SSD Weight” of the aggregates by following the Formula provided ** on the Form. 700.04. Round to the nearest pound.

$$\text{SSD Weight Actual} = \frac{\text{Batched Weight}}{(1 + \text{Moisture Content})}$$

Coarse Aggregate:
 $22197 / (1.00 + 0.01) = 21977 \text{ lbs}$

Fine Aggregate:
 $11130 / (1.00 + 0.03) = 10806 \text{ lbs}$

| IF SINGLE BATCHED OR SUM OF DBL BATCH | MEETS BATCH CHART RANGE | | FREE MOISTURE PERCENT | SSD WEIGHT ACTUAL * BATCH WEIGHT DIVIDED BY (1+%Moist.) | TOTAL LBS WATER IN LOAD |
|---------------------------------------|-------------------------|----|-----------------------|---|--|
| | YES | NO | | | |
| ACTUAL BATCH WEIGHT | | | | | |
| 5535 | | | | | |
| 431 | | | | | |
| 5966 | | | | | FREE AGG. MOISTURE = ACT. BATCH WT. MINUS SSD WEIGHT |
| 22197 | | | 0.01 | 21977 | |
| 11130 | | | 0.03 | 10806 | |
| | | | | | |
| | | | | | |
| 235 | | | | | |
| | | | 32 oz / GAL | (DCI ONLY) | |
| | | | | GAL X 8.33 = | |
| | | | | METER WATER LBS. _____ = | |
| | | | | Max. Water Allowed for Site Additions | |
| | | | | GAL. | LBS. |
| | | | | TOTAL WATER AT PLANT = | |
| | | | | | |
| 1st WATER ADDED AT SITE | | | | GAL x 8.33 = LBS. | |
| 2nd WATER ADDED AT SITE | | | | GAL x 8.33 = LBS. | |
| | | | | TOTAL WATER IN LOAD = (SUM) _____ LBS. | |

700.04 Form



STEP 16c. Determine the “Free Aggregate Moisture” by subtracting the SSD Wt. from the “Actual Batch Weights” for each type of Aggregate.

Coarse Aggregate:

$$22197 - 21977 = 220$$

Fine Aggregate:

$$11130 - 10806 = 324$$

| IF SINGLE BATCHED OR SUM OF DBL BATCH | MEETS BATCH CHART RANGE | | FREE MOISTURE PERCENT | SSD WEIGHT ACTUAL** BATCH WEIGHT DIVIDED BY (1+%Moist.) | TOTAL LBS WATER IN LOAD |
|---------------------------------------|---------------------------------------|----|-----------------------|---|--|
| | YES | NO | | | |
| ACTUAL BATCH WEIGHT | | | | | |
| 5535 | | | | | |
| 431 | | | | | |
| 5966 | | | | | FREE AGG. MOISTURE = ACT. BATCH WT. MINUS SSD WEIGHT |
| 22197 | | | 0.01 | 21977 | 220 |
| 11130 | | | 0.03 | 10806 | 324 |
| | | | | | |
| | | | | | |
| 235 | | | 32 oz / GAL | (DCI ONLY) | |
| | TRUCK WASH WATER | | | GAL X 8.33 = | |
| | METER WATER LBS. | | | | |
| | Max. Water Allowed for Site Additions | | | | |
| | GAL. | | | | |
| | LBS. | | | | |
| | TOTAL WATER AT PLANT = | | | | |
| | 1st WATER ADDED AT SITE | | | GAL x 8.33 = LBS. | |
| | 2nd WATER ADDED AT SITE | | | GAL x 8.33 = LBS. | |
| | TOTAL WATER IN LOAD = (SUM) | | | | |

700.04 Form



STEP 19. To determine the “Maximum Water Allowed for the Mix AS Batched”, multiply the correct w/c ratio by the “Actual Batch Wt. Total Cementitious Material”.

For this example: The correct w/c ratio is 0.46 according to the SCDOT Structural Concrete Table in section 701.20 of the Construction Manual for a **Crushed Stone**.

| | |
|---|-------------|
| MAX WATER ALLOWED FOR THE MIX AS BATCHED | 2744 |
|---|-------------|

| MATERIALS | BATCH CHART TOTAL WEIGHT | TOLERANCE | BATCH CHART TOTAL WEIGHT RANGE | | IF SINGLE OR DOUBLE BATCHED | | IF SINGLE BATCHED OR SUM OF DBL BATCH | MEETS BATCH CHART RANGE | | | |
|-----------------------|--------------------------|-----------|--------------------------------|--------|------------------------------|---------------------|---------------------------------------|-------------------------|----|--|------------------|
| | | | LOW - | HIGH + | ACTUAL BATCH WEIGHT (single) | ACTUAL BATCH WEIGHT | | YES | NO | | |
| | | | | | | | | | | | |
| CEMENT, LBS. | | -1% | 5475 | | | | 5535 | | | | |
| FLY ASH, LBS. | | -1% | 416 | | | | 431 | | | | |
| SILICA FUME, LBS. | | -1% | | | | | | | | | |
| TOTAL CEM. MATL. | | -1% | 5891 | | | | 5966 | | | | |
| AGGREGATE (1) LBS | | +2% | 21364 | 22236 | | | 22197 | | | | |
| AGGREGATE (2) LBS | | +2% | 10800 | 11240 | | | 11130 | | | | |
| AGGREGATE (3) LBS | | +2% | | | | | | | | | |
| TOTAL (1) + (2) + (3) | | — | | | | | | | | | |
| CRP. INHIB., GAL | | — | | | | | | | | | |
| METER WATER GAL | | | | | | | | | | | TRUCK WASH WATER |

PLANT INSPECTOR: _____ MAX. WATER ALLOWED FOR THE MIX $0.46 \times 5966 = 2744$

STEP 20. Determine the “Max Water Allowed for Site Additions” by subtracting the “Total Water Added at Plant” from the “Max Water Allowed for the Mix AS Batched”. Convert the weight of water into gallons by dividing the weight by 8.33.

$$2744 - 2502 = 242 \text{ lbs}$$

$$243 \text{ lbs}/8.33 = 29.2 \text{ Gallons} \quad \text{Do NOT Round Up to Next Gallon}$$

| | |
|--|------|
| MAX WATER ALLOWED FOR THE MIX AS BATCHED | 2744 |
|--|------|

| | | |
|-------------------------------------|--|-------------|
| | Max. Water Allowed for Site Additions | |
| GAL. 29 | LBS. 242 | |
| TOTAL WATER ADDED AT PLANT = | | 2502 |
| 1 ST Water Added at Site | Gal x 8.33 = Lbs | |
| | Gal x 8.33 = Lbs | |
| TOTAL WATER IN LOAD = (SUM) _____ | | LBS. _____ |



STEP 21. According to the Problem Statement, this truck load required a slump adjustment of two inches. The accepted formula for slump adjustments states that 1 yd³ on concrete will increase in slump by 1 inch for each 1 gallon of water added. (Inches to move x # of yd³s = Gallons Required.)

In this example, there are 10 yd³ of material to be moved 2”

2 inches x 10 yd³ = 20 Gallons

20 Gallons x 8.33 = 167 lbs. of Water for 1st Site Addition

Repeat for the 2nd Water Added At Site if required.

| Max. Water Allowed for Site Additions | |
|--|------------------|
| GAL. | LBS. |
| 29 | 242 |
| TOTAL WATER ADDED AT PLANT = | |
| 2502 | |
| 1 ST Water Added at Site | 20 |
| | Gal x 8.33 = Lbs |
| | Gal x 8.33 = Lbs |
| TOTAL WATER IN LOAD = (SUM) _____ LBS. | |



STEP 22. The Total Water in the Load (SUM) is determined by adding the Total Water Added at the Plant plus any on-site water additions.

$$\text{Total Water in the Load} = 2502 + 167 = 2669$$

| | | | |
|--|--|------------------|-------------|
| | Max. Water Allowed for Site Additions | | |
| | GAL. 29 | LBS. 242 | |
| | TOTAL WATER ADDED AT PLANT = | | 2502 |
| 1 ST Water Added at Site | 20 | Gal x 8.33 = Lbs | 167 |
| | | Gal x 8.33 = Lbs | |
| TOTAL WATER IN LOAD = (SUM) _____ LBS. | | | 2669 |



STEP 23. Calculate the Water to Cementitious Material Ratio by dividing the Total Water in the Load (2669 lbs) by the Total Cementitious Material's Actual Batch Weight (5966 lbs.)

$$\text{Ratio} = \frac{\text{Total Water in Load (lbs.)}}{\text{Total Cementitious Material (lbs.)}} = \frac{2669 \text{ lbs. Water}}{5966 \text{ lbs. Cem. Matl.}} = \boxed{0.45}$$

STEP 24. Compare the w/c ratio for this load (**0.45**) to the w/c for this class of PCC (**0.46**).

STEP 24. It is the Field Inspector's job to fill out all of the relevant information below for each Form 700.04.

| | | |
|--------------------------------------|---|-----------------------------------|
| COMMENTS: _____ | MIXING REV. AT SITE: _____ | REV. AFTER SITE WATER ADDED _____ |
| SLUMP: _____ | ADDMIXTURE ADDED AT SITE: _____ | TOTAL α _____ |
| ENTR. AIR %: _____ | | oz / 100 LBS _____ |
| CYLINDERS MADE (NO / YES): _____ | MIXING TIME AFTER ADDING ADMIXTURE: _____ | MINUTES _____ |
| ID #: _____ | CONCRETE TEMPERATURE @ PLACEMENT: _____ | DEG. F _____ |
| TIME UNLOADING OF TRUCK ENDED: _____ | | |
| POUR LOCATION: _____ | | |
| FIELD INSPECTOR: _____ | | |

*FILL IN FOR 1st LOADS EACH DAY - THEN ONLY IF THERE IS A CHANGE.
 **ADD 1.00 TO MOISTURE % (DECIMAL FORM)

Bottom Portion of 700.04 Form



FILE NO: **34.017** DATE: **10/31/2016** CLASS **3000** LOAD NO. **2** CU YDS **10** ACC. CY **20** TRUCK # **46**

TIME MIXING BEGAN: _____

REV. @ PLANT, @ MIXING SPEED _____

PLANT AND LOCATION _____

PLANT INSPECTOR: **John Q. Doe**

MAX. WATER ALLOWED FOR THE MIX **0.46 X 5966 = 2744**

| MATERIALS | * BATCH CHART TOTAL WEIGHT | TOLERANCE | BATCH CHART TOTAL WEIGHT RANGE | | IF SINGLE OR DOUBLE BATCHED | | MEETS BATCH CHART RANGE | | * FREE MOISTURE PERCENT | SSD WEIGHT ACTUAL * BATCH WEIGHT DIVIDED BY (1+*Moist.) | TOTAL LBS WATER IN LOAD |
|---------------------------|----------------------------|-----------|--------------------------------|--------------|------------------------------|---------------------|-------------------------|---------------------------------------|-------------------------|---|-------------------------|
| | | | LOW - | HIGH + | ACTUAL BATCH WEIGHT (single) | ACTUAL BATCH WEIGHT | YES | NO | | | |
| CEMENT, LBS. | 5530 | -1% | 5475 | | | 5535 | X | | | | |
| FLY ASH, LBS. | 420 | -1% | 416 | | | 431 | X | | | FREE AGG. MOISTURE = ACT. BATCH WT. MINUS SSD WEIGHT | |
| SILICA FUME, LBS. | 5950 | -1% | 5891 | | | 5966 | X | | | | |
| TOTAL CEM. MATL. | 21800 | +2% | 21582 | 22236 | | 22197 | X | | 0.01 | 21977 | 220 |
| AGGREGATE (1) LBS | 11020 | +2% | 10800 | 11240 | | 11130 | X | | 0.03 | 10806 | 324 |
| AGGREGATE (2) LBS | | +2% | | | | | | | | | |
| AGGREGATE (3) LBS | 32820 | +2% | | | | | | | | | |
| TOTAL (1) + (2) + (3) | | - | | | | | | | | | |
| CRR. INHIB., GAL | | - | | | | | | | 32 oz / GAL | (DCI ONLY) | |
| METER WATER GAL | 264 | | | | | 264-29=235 | | TRUCK WASH WATER | | GAL. X 8.33 = | 1958 |
| METER WATER LBS | 2199 | | oz / BAG | oz / 100 LBS | | 235 x 8.33 = 1958 | | METER WATER LBS. | | | |
| AIR ENT. AGENT, oz | 38 | 0.60 | | | | | | Max. Water Allowed for Site Additions | | | |
| WATER RED. AGENT, oz | 149 | | | 2.5 | | | | GAL. 29 LBS. 242 | | | |
| WATER RED/RETARDED, oz | | | | | | | | TOTAL WATER AT PLANT = | | | 2502 |
| MIR/HR WATER RED. RET. oz | | | | | | | | | | | |

CALCULATION OF WATER/CEMENTITIOUS MATERIAL RATIO:

RATIO = TOTAL WATER IN LOAD (LBS) = **2669** = **0.45**
 TOTAL CEM. MATL. (LBS) **5966**

COMMENTS: _____
 SLUMP: _____ ENTR. AIR %: _____
 CYLINDERS MADE (NO / YES): _____ ID #: _____
 TIME UNLOADING OF TRUCK ENDED: _____
 POUR LOCATION: _____
 FIELD INSPECTOR: _____

MIXING REV. AT SITE: _____ TOTAL oz _____ REV. AFTER SITE WATER ADDED _____
 ADMIXTURE ADDED AT SITE: _____ oz / 100 LBS _____
 MIXING TIME AFTER ADDING ADMIXTURE: _____ MINUTES _____
 CONCRETE TEMPERATURE @ PLACEMENT: _____ DEG. F _____

*FILL IN FOR 1st LOADS EACH DAY - THEN ONLY IF THERE IS A CHANGE.
 **ADD 1.00 TO MOISTURE % (DECIMAL FORM)

Two external sources of information are required to complete the Form 700.04. They are the **Structural Concrete Table** (needed only for the water to cementitious material ratio) and a **batch ticket or batch computer screen**.



THINGS TO REMEMBER

- Verify that the proper mix is being used.
- Make sure that proper materials per mix design are being used.
- Always ROUND DOWN – Gallon units only!
- Make sure that proper mixing is complete before the truck leaves the plant



Example Q2

Use the Class 5000 concrete batch ticket with 13% Fly Ash to complete the Form 700.04 example problem.

Form 700.04

Required Mix Design

Total Concrete required for the pour:
64 cubic yards, delivered by eight trucks carrying eight cubic yards each

Class 5000 Concrete with 13% Fly Ash

| <u>Aggregates</u> | <u>Aggregate Type</u> | <u>Moisture Percentage</u> |
|-------------------|-----------------------|----------------------------|
| Coarse: | Crushed Stone | damp |
| Fine: | Sand | 7.00% |

| <u>Admixture</u> | <u>Dosage Rate</u> |
|------------------|--------------------|
| Air Entrainer | 0.3 oz/bag |
| Water Reducer | 3.5 oz/100 Lbs. |

Cement Scale: 6,000 Lbs. Max
Aggregate Scale: 25,000 Lbs. Max

Water:

First Site Addition: Enough to increase the slump by 1.5 inches
Second Site Addition:

Mix Information as Batched

| TRUCK | FILE # | USER | DISPATCH TICKET NUMBER | TICKET ID | BATCH TIME | DATE |
|-------|--------|-----------|------------------------|-----------|------------|------------|
| 98 | 34.017 | D. Taylor | 654984 | 48966 | 1:32 AM | 11/28/2009 |

| LOAD SIZE | MIX CODE | RETURNED QUANTITY | CUMMULATIVE YARDS |
|-----------|-----------|-------------------|-------------------|
| 8.00 CY | 5000AEDOT | 0 | 32 Y |

| MATERIAL | DESIGN QTY (SSD/YD) | TARGET WEIGHT | BATCHED | % Var | % Moisture |
|-----------------|---------------------|---------------|----------|--------|------------|
| Coarse Agg | 1835 lb | 14680 lb | 14824 lb | 0.98% | 0.50% |
| Int Agg | | | | | 0.00% |
| Fine Agg | 1025 lb | 8200 lb | 8077 lb | -1.50% | 7.00% |
| Total Agg (lbs) | | | | | |
| Cement | 613 lb | 4904 lb | 4953 lb | 1.00% | |
| Fly Ash | 110 lb | 880 lb | 924 lb | 5.00% | |
| WR | 3.5 oz/100 lbs | | | | |
| Air | 0.3 oz/bag | | | | |
| Water (lbs) | 257 lb | 2056 lb | | | |
| Water (gal) | | 246 gal | 221 gal | | |

Example Q3

Use the Class 5000 concrete batch ticket with 13% Fly Ash to complete the Form 700.04 example problem.

Form 700.04

Required Mix Design

Total Concrete required for the pour:
27 cubic yards, delivered by nine trucks carrying 3 cubic yards each

Class 5000 Concrete with 13% Fly Ash

| | | |
|--------------------------|------------------------------|-----------------------------------|
| <u>Aggregates</u> | <u>Aggregate Type</u> | <u>Moisture Percentage</u> |
| Coarse: | Crushed Stone | damp |
| Fine: | Sand | 4.00% |

| | |
|-------------------------|---------------------------|
| <u>Admixture</u> | <u>Dosage Rate</u> |
| Air Entrainer | 0.2 oz/bag |
| Water Reducer | 2.5 oz/100 Lbs. |

Cement Scale: 4,000 Lbs. Max
Aggregate Scale: 25,000 Lbs. Max

Water:

First Site Addition: 6 gallons
Second Site Addition:

Mix Information as Batched

| | | | | | | |
|-----------------------------|------------------------------|-------------------------------|---|---------------------------|------------------------------|---------------------------|
| TRUCK 4 | FILE # 31.017 | USER S. Roland | DISPATCH TICKET NUMBER 874961 | TICKET ID 14766 | BATCH TIME 8:19 PM | DATE 11/30/2013 |
| LOAD SIZE 3.00 CY | MIX CODE 5000AEDOT | RETURNED QUANTITY 0 | CUMMULATIVE YARDS 21 Y | | | |
| MATERIAL | DESIGN QTY (SSD/YD) | TARGET WEIGHT | BATCHED | % Var | % Moisture | |
| Coarse Agg | 1835 lb | 5505 lb | 5560 lb | 1.00% | 0.50% | |
| Int Agg | | | | | | |
| Fine Agg | 1044 lb | 3132 lb | 3085 lb | -1.50% | 4.00% | |
| Total Agg (lbs) | | | | | | |
| Cement | 613 lb | 1839 lb | 1857 lb | 0.98% | | |
| Fly Ash | 110 lb | 330 lb | 347 lb | 5.15% | | |
| WR | 2.5 oz/100 lbs | | | | | |
| Air | 0.2 oz/bag | | | | | |
| Water (lbs) | 266 lb | 798 lb | | | | |
| Water (gal) | | 95 gal | 87 gal | | | |

Example Q4

Use the Class 5000 concrete batch ticket with 13% Fly Ash to complete the Form 700.04 example problem.

Form 700.04

Required Mix Design

Total Concrete required for the pour:
81 cubic yards, delivered by nine trucks carrying 9 cubic yards each

Class 5000 Concrete with 13% Fly Ash

| <u>Aggregates</u> | <u>Aggregate Type</u> | <u>Moisture Percentage</u> |
|-------------------|-----------------------|----------------------------|
| Coarse: | Crushed Stone | damp |
| Fine: | Sand | 3.00% |

| <u>Admixture</u> | <u>Dosage Rate</u> |
|------------------|--------------------|
| Air Entrainer | 0.5 oz/bag |
| Water Reducer | 2.6 oz/100 Lbs. |

Cement Scale: 10,000 Lbs. Max
Aggregate Scale: 50,000 Lbs. Max

Water:

First Site Addition: 18 GAL
Second Site Addition:

Mix Information as Batched

| TRUCK | FILE # | USER | DISPATCH TICKET NUMBER | TICKET ID | BATCH TIME | DATE |
|-----------------|---------------------|-------------------|------------------------|-----------|------------|------------|
| 24 | 34.013 | Q. Smith | 156946 | 2568 | 2:55PM | 11/26/2011 |
| LOAD SIZE | MIX CODE | RETURNED QUANTITY | CUMMULATIVE YARDS | | | |
| 9.00 CY | 5000AEDOT | 0 | 18 Y | | | |
| MATERIAL | DESIGN QTY (SSD/YD) | TARGET WEIGHT | BATCHED | % Var | % Moisture | |
| Coarse Agg | 1835 lb | 16515 lb | 16680 lb | 1.00% | 0.50% | |
| Int Agg | | | | | 0.00% | |
| Fine Agg | 987 lb | 8883 lb | 8750 lb | -1.50% | 3.00% | |
| Total Agg (lbs) | | | | | | |
| Cement | 613 lb | 5517 lb | 5572 lb | 1.00% | | |
| Fly Ash | 110 lb | 990 lb | 1040 lb | 5.05% | | |
| WR | 2.6 oz/100 lbs | | | | | |
| Air | 0.5 oz/bag | | | | | |
| Water (lbs) | 295 lb | 2655 lb | | | | |
| Water (gal) | | 318 gal | 300 gal | | | |

| MATERIALS | * BATCH CHART TOTAL WEIGHT | TOLERANCE | * BATCH CHART TOTAL WEIGHT RANGE | | IF SINGLE OR DOUBLE BATCHED | | IF SINGLE BATCHED OR SUM OF DBL BATCH | MEETS BATCH CHART RANGE | | * FREE MOISTURE PERCENT | SSD WEIGHT ACTUAL ** BATCH WEIGHT DIVIDED BY (1+-%Moist.) | TOTAL LBS WATER IN LOAD |
|--------------------------|----------------------------|-----------|----------------------------------|--------------|------------------------------|---------------------|---------------------------------------|---------------------------------------|-------|-------------------------|---|-------------------------|
| | | | LOW - | HIGH + | ACTUAL BATCH WEIGHT (single) | ACTUAL BATCH WEIGHT | | Yes | No | | | |
| CEMENT, LBS. | 4904 | -1% | 4855 | | | | 4953 | ok | | | | |
| FLY ASH, LBS. | 880 | -1% | 871 | | | | 924 | ok | | | | |
| SILICA FUME, LBS. | | -1% | | | | | | | | | | |
| TOTAL CEM. MATL. | 5784 | -1% | 5726 | | | | 5877 | ok | | | | |
| AGGREGATE (1) LBS | 14680 | +2% | 14386 | 14974 | | | 14824 | ok | 0.005 | 14750 | 74 | |
| AGGREGATE (2) LBS | 8200 | +2% | 8036 | 8364 | | | 8077 | ok | 0.07 | 7549 | 528 | |
| AGGREGATE (3) LBS | | +2% | | | | | | | | | | |
| TOTAL (1) + (2) + (3) | 22880 | | | | | | | | | | | |
| CRR. INHIB., GAL | | | | | | | | | | | | |
| METER WATER GAL | 246 | | *RATE | | | | 221 | TRUCK WASH WATER | | | | |
| METER WATER LBS | 2056 | | oz / BAG | oz / 100 LBS | | | 1841 | METER WATER LBS. | | | | 1841 |
| AIR ENT. AGENT, oz | 18 | | 0.3 | | | | | Max. Water Allowed for Site Additions | | | | |
| WATER RED. AGENT, oz | 202 | | | 3.5 | | | | GAL. 31 LBS. 260 | | | | |
| WATER RED/RETARDED, oz | | | | | | | | TOTAL WATER AT PLANT = | | | | 2443 |
| MP/HR WATER RED. RET. oz | | | | | | | | | | | | |

CALCULATION OF WATER/CEMENTITIOUS MATERIAL RATIO:

RATIO = TOTAL WATER IN LOAD (LBS) = 2543.000 / TOTAL CEM. MATL. (LBS) 5877 = 0.430

1st WATER ADDED AT SITE 12 GAL. x 8.33 = LBS. 100

2nd WATER ADDED AT SITE 0 GAL. x 8.33 = LBS. 0

TOTAL WATER IN LOAD = (SUM) LBS. 2543

COMMENTS: Ok w/c

SLUMP: _____ ENTR. AIR %: _____

CYLINDERS MADE (NO / YES): _____ ID #: _____

TIME UNLOADING OF TRUCK ENDED: _____

MIXING REV. AT SITE: _____ REV. AFTER SITE WATER ADDED _____

ADMIXTURE ADDED AT SITE: _____ TOTAL oz _____ oz / 100 LBS

MIXING TIME AFTER ADDING ADMIXTURE: _____ MINUTES

CONCRETE TEMPERATURE @ PLACEMENT: _____ DEG. F

* FILL IN FOR 1st LOADS EACH DAY - THEN ONLY IF THERE IS A CHANGE.

** ADD 1.00 TO MOISTURE % (DECIMAL FORM)

FILE NO: 31.017 DATE: 11/30/2013 CLASS 5000 LOAD NO. 7 CU YDS 3 ACC. CY 21 TRUCK # 4
 TIME MIXING BEGAN: 8:19 PM REV. @ PLANT, @ MIXING SPEED 70 PLANT AND LOCATION
 PLANT INSPECTOR: S. Roland MAX. WATER ALLOWED FOR THE MIX 1014 LBS 122 GAL. W/C RATIO 0.46

| MATERIALS | * BATCH CHART TOTAL WEIGHT | TOLERANCE | * BATCH CHART TOTAL WEIGHT RANGE | | IF SINGLE OR DOUBLE BATCHED | | IF SINGLE BATCHED OR SUM OF DBL BATCH ACTUAL BATCH WEIGHT | MEETS BATCH CHART RANGE | | * FREE MOISTURE PERCENT | SSD WEIGHT ACTUAL ** BATCH WEIGHT DIVIDED BY (1+-%Moist.) | TOTAL LBS WATER IN LOAD |
|--------------------------|----------------------------------|-----------|--|--------------|---------------------------------------|---------------------------|--|---------------------------------------|------|----------------------------------|--|-------------------------|
| | | | LOW - | HIGH + | ACTUAL BATCH WEIGHT (single) | ACTUAL BATCH WEIGHT | | LOW | HIGH | | | |
| CEMENT, LBS. | 1839 | -1% | 1821 | | | | 1857 | YES | YES | | | |
| FLY ASH, LBS. | 330 | -1% | 327 | | | | 347 | YES | YES | | | |
| SILICA FUME, LBS. | | -1% | | | | | 0 | YES | YES | | | |
| TOTAL CEM. MATL. | 2169 | -1% | 2147 | | | | 2204 | YES | YES | | | |
| AGGREGATE (1) LBS | 5505 | +2% | 5395 | 5615 | | | 5560 | YES | YES | 0.5 | 5532 | 28 |
| AGGREGATE (2) LBS | 3132 | +2% | 3069 | 3195 | | | 3085 | YES | YES | 4 | 2966 | 119 |
| AGGREGATE (3) LBS | 0 | +2% | | | | | | YES | YES | | | |
| TOTAL (1) + (2) + (3) | 8637 | +2% | 8464 | 8810 | | | 8645 | YES | YES | | | |
| CRR. INHIB., GAL | | | | | | | | | | | | |
| METER WATER GAL | 95 | | *RATE | | | | 87 | TRUCK WASH WATER | | 32 oz / GAL | (DCI ONLY) | |
| METER WATER LBS | 791 | | oz / BAG | oz / 100 LBS | | | 725 | METER WATER LBS. | | | | 725 |
| AIR ENT. AGENT, oz | 5 | | 0.2 | | | | 5 | Max. Water Allowed for Site Additions | | | | |
| WATER RED. AGENT, oz | 54 | | 2.5 | | | | 54 | GAL. 17 LBS. 143 | | | | |
| WATER RED/RETARDED, oz | | | | | | | | TOTAL WATER AT PLANT = | | | | 871 |
| MP/HR WATER RED. RET. oz | | | | | | | | | | | | |

CALCULATION OF WATER/CEMENTITIOUS MATERIAL RATIO:
 RATIO = TOTAL WATER IN LOAD (LBS) = 921 = 0.42
 TOTAL CEM. MATL. (LBS) 2204

COMMENTS: _____
 SLUMP: _____ ENTR. AIR %: _____
 CYLINDERS MADE (NO / YES): _____ ID #: _____
 TIME UNLOADING OF TRUCK ENDED: _____
 MIXING REV. AT SITE: _____ REV. AFTER SITE WATER ADDED _____
 ADMIXTURE ADDED AT SITE: _____ TOTAL oz _____ oz / 100 LBS
 MIXING TIME AFTER ADDING ADMIXTURE: _____ MINUTES
 CONCRETE TEMPERATURE @ PLACEMENT: _____ DEG. F

* FILL IN FOR 1st LOADS EACH DAY - THEN ONLY IF THERE IS A CHANGE.
 ** ADD 1.00 TO MOISTURE % (DECIMAL FORM)

| MATERIALS | * BATCH CHART TOTAL WEIGHT | TOLERANCE | * BATCH CHART TOTAL WEIGHT RANGE | | IF SINGLE OR DOUBLE BATCHED | | IF SINGLE BATCHED OR SUM OF DBL BATCH ACTUAL BATCH WEIGHT | MEETS BATCH CHART RANGE | | * FREE MOISTURE PERCENT | SSD WEIGHT ACTUAL ** BATCH WEIGHT DIVIDED BY (1+-%Moist.) | TOTAL LBS WATER IN LOAD |
|--------------------------|----------------------------|-----------|----------------------------------|--------|------------------------------|---------------------|---|-------------------------|---------------------------------------|-------------------------|---|-------------------------|
| | | | LOW - | HIGH + | ACTUAL BATCH WEIGHT (single) | ACTUAL BATCH WEIGHT | | LOW | HIGH | | | |
| CEMENT, LBS. | 5517 | -1% | 5462 | | | | 5572 | YES | YES | | | |
| FLY ASH, LBS. | 990 | -1% | 980 | | | | 1040 | YES | YES | | | |
| SILICA FUME, LBS. | | -1% | | | | | | YES | | | | |
| TOTAL CEM. MATL. | 6507 | -1% | 6442 | | | | 6612 | YES | YES | | | |
| AGGREGATE (1) LBS | 16515 | +2% | 16185 | 16845 | | | 16680 | YES | YES | 0.5 | 16597 | 83 |
| AGGREGATE (2) LBS | 8883 | +2% | 8705 | 9061 | | | 8750 | YES | YES | 3 | 8495 | 255 |
| AGGREGATE (3) LBS | | +2% | | | | | | YES | YES | | | |
| TOTAL (1) + (2) + (3) | 25398 | +2% | 24890 | 25906 | | | 25430 | YES | YES | | | |
| CRR. INHIB., GAL | | | | | | | | | | | | |
| METER WATER GAL | 318 | | | | | | 300 | | TRUCK WASH WATER | 32 oz / GAL | | |
| METER WATER LBS | 2649 | | | | | | 2499 | | METER WATER LBS. = | | | 2499 |
| AIR ENT. AGENT, oz | 35 | | 0.5 | | | | 35 | | Max. Water Allowed for Site Additions | | | |
| WATER RED. AGENT, oz | 169 | | | 2.6 | | | 169 | | GAL. 24 LBS. 205 | | | |
| WATER RED/RETARDED, oz | | | | | | | | | TOTAL WATER AT PLANT = | | | 2837 |
| MP/HR WATER RED. RET. oz | | | | | | | | | | | | |

CALCULATION OF WATER/CEMENTITIOUS MATERIAL RATIO:
 RATIO = TOTAL WATER IN LOAD (LBS) = 2987.000 / TOTAL CEM. MATL. (LBS) 6612 = 0.450

COMMENTS: _____ MIXING REV. AT SITE: _____ REV. AFTER SITE WATER ADDED _____
 SLUMP: _____ ENTR. AIR %: _____ ADMIXTURE ADDED AT SITE: _____ TOTAL oz _____ oz / 100 LBS
 CYLINDERS MADE (NO / YES): _____ ID #: _____ MIXING TIME AFTER ADDING ADMIXTURE: _____ MINUTES
 TIME UNLOADING OF TRUCK ENDED: _____ CONCRETE TEMPERATURE @ PLACEMENT: _____ DEG. F

* FILL IN FOR 1st LOADS EACH DAY - THEN ONLY IF THERE IS A CHANGE.
 ** ADD 1.00 TO MOISTURE % (DECIMAL FORM)

FILE NO: _____ DATE: _____ CLASS _____ LOAD NO. _____ CU YDS _____ ACC. CY _____ TRUCK # _____
 TIME MIXING BEGAN: _____ REV. @ PLANT, @ MIXING SPEED _____ PLANT AND LOCATION _____
 PLANT INSPECTOR: _____ MAX. WATER ALLOWED FOR THE MIX _____

| MATERIALS | * BATCH CHART TOTAL WEIGHT | TOLERANCE | * BATCH CHART TOTAL WEIGHT RANGE | | IF SINGLE OR DOUBLE BATCHED | | IF SINGLE BATCHED OR SUM OF DBL BATCH | MEETS BATCH CHART RANGE | | * FREE MOISTURE PERCENT | SSD WEIGHT ACTUAL ** BATCH WEIGHT DIVIDED BY (1+%(Moist.)) | TOTAL LBS WATER IN LOAD |
|--|----------------------------|-----------|----------------------------------|--------------|------------------------------|---------------------|---------------------------------------|-------------------------|----|-------------------------|--|-------------------------|
| | | | LOW - | HIGH + | ACTUAL BATCH WEIGHT (single) | ACTUAL BATCH WEIGHT | | YES | NO | | | |
| CEMENT, LBS. | | -1% | | | | | | | | | | |
| FLY ASH, LBS. | | -1% | | | | | | | | | | |
| SILICA FUME, LBS. | | -1% | | | | | | | | | | |
| TOTAL CEM. MATL. | | -1% | | | | | | | | | | |
| AGGREGATE (1) LBS | | +2% | | | | | | | | | | |
| AGGREGATE (2) LBS | | +2% | | | | | | | | | | |
| AGGREGATE (3) LBS | | +2% | | | | | | | | | | |
| TOTAL (1) + (2) + (3) | | | | | | | | | | | | |
| CRR. INHIB. GAL | | | | | | | | | | | | |
| METER WATER GAL | | | | | | | | | | | | |
| METER WATER LBS | | | oz / BAG | oz / 100 LBS | | | | | | | | |
| AIR ENT. AGENT, oz | | | | | | | | | | | | |
| WATER RED. AGENT, oz | | | | | | | | | | | | |
| WATER RED/RETARDED, oz | | | | | | | | | | | | |
| MR/HR WATER RED. RET. oz | | | | | | | | | | | | |
| * RATE TRUCK WASH WATER METER WATER LBS. = GAL. X 8.33 = | | | | | | | | | | | | |
| Max. Water Allowed for Site Additions GAL. LBS. TOTAL WATER AT PLANT = | | | | | | | | | | | | |
| CALCULATION OF WATER/CEMENTITIOUS MATERIAL RATIO: RATIO = TOTAL WATER IN LOAD (LBS) = _____ = _____ TOTAL CEM. MATL. (LBS) | | | | | | | | | | | | |
| 1st WATER ADDED AT SITE 2nd WATER ADDED AT SITE TOTAL WATER IN LOAD = (SUM) = _____ LBS. | | | | | | | | | | | | |

COMMENTS: _____ MIXING REV. AT SITE: _____ REV. AFTER SITE WATER ADDED _____
 SLUMP: _____ ENTR. AIR %: _____ TOTAL oz _____ oz / 100 LBS
 CYLINDERS MADE (NO / YES): _____ ID #: _____ MINUTES _____
 TIME UNLOADING OF TRUCK ENDED: _____ CONCRETE TEMPERATURE @ PLACEMENT: _____ DEG. F _____

* FILL IN FOR 1st LOADS EACH DAY - THEN ONLY IF THERE IS A CHANGE.
 ** ADD 1.00 TO MOISTURE % (DECIMAL FORM)

FILE NO: _____ DATE: _____ CLASS _____ LOAD NO. _____ CU YDS _____ ACC. CY _____ TRUCK # _____
 TIME MIXING BEGAN: _____ REV. @ PLANT, @ MIXING SPEED _____ PLANT AND LOCATION _____
 PLANT INSPECTOR: _____ MAX. WATER ALLOWED FOR THE MIX _____

| MATERIALS | * BATCH CHART TOTAL WEIGHT | TOLERANCE | * BATCH CHART TOTAL WEIGHT RANGE | | IF SINGLE OR DOUBLE BATCHED | | IF SINGLE BATCHED OR SUM OF DBL BATCH | MEETS BATCH CHART RANGE | | * FREE MOISTURE PERCENT | SSD WEIGHT ACTUAL ** BATCH WEIGHT DIVIDED BY (1+%(Moist.)) | TOTAL LBS WATER IN LOAD |
|--|----------------------------|-----------|----------------------------------|--------------|------------------------------|---------------------|---------------------------------------|-------------------------|----|-------------------------|--|--|
| | | | LOW - | HIGH + | ACTUAL BATCH WEIGHT (single) | ACTUAL BATCH WEIGHT | | YES | NO | | | |
| CEMENT, LBS. | | -1% | | | | | | | | | | |
| FLY ASH, LBS. | | -1% | | | | | | | | | | |
| SILICA FUME, LBS. | | -1% | | | | | | | | | | |
| TOTAL CEM. MATL. | | -1% | | | | | | | | | | FREE AGG. MOISTURE = ACT. BATCH WT. MINUS SSD WEIGHT |
| AGGREGATE (1) LBS | | +2% | | | | | | | | | | |
| AGGREGATE (2) LBS | | +2% | | | | | | | | | | |
| AGGREGATE (3) LBS | | +2% | | | | | | | | | | |
| TOTAL (1) + (2) + (3) | | | | | | | | | | | | |
| CRR. INHIB., GAL | | | | | | | | | | | | |
| METER WATER GAL | | | | | | | | | | | | |
| METER WATER LBS | | | oz / BAG | oz / 100 LBS | | | | | | | | |
| AIR ENT. AGENT, oz | | | | | | | | | | | | |
| WATER RED. AGENT, oz | | | | | | | | | | | | |
| WATER RED/RETARDED, oz | | | | | | | | | | | | |
| MR/HR WATER RED. RET. oz | | | | | | | | | | | | |
| * RATE TRUCK WASH WATER METER WATER LBS. = GAL. X 8.33 = | | | | | | | | | | | | |
| Max. Water Allowed for Site Additions GAL. LBS. TOTAL WATER AT PLANT = | | | | | | | | | | | | |
| CALCULATION OF WATER/CEMENTITIOUS MATERIAL RATIO: RATIO = TOTAL WATER IN LOAD (LBS) = _____ = _____ TOTAL CEM. MATL. (LBS) | | | | | | | | | | | | |
| 1st WATER ADDED AT SITE 2nd WATER ADDED AT SITE TOTAL WATER IN LOAD = (SUM) = _____ LBS. | | | | | | | | | | | | |

COMMENTS: _____ MIXING REV. AT SITE: _____ REV. AFTER SITE WATER ADDED _____
 SLUMP: _____ ENTR. AIR %: _____ ADMIXTURE ADDED AT SITE: _____ TOTAL oz _____ oz / 100 LBS
 CYLINDERS MADE (NO / YES): _____ ID #: _____ MIXING TIME AFTER ADDING ADMIXTURE: _____ MINUTES
 TIME UNLOADING OF TRUCK ENDED: _____ CONCRETE TEMPERATURE @ PLACEMENT: _____ DEG. F

* FILL IN FOR 1st LOADS EACH DAY - THEN ONLY IF THERE IS A CHANGE.
 ** ADD 1.00 TO MOISTURE % (DECIMAL FORM)

FILE NO: _____ DATE: _____ CLASS _____ LOAD NO. _____ CU YDS _____ ACC. CY _____ TRUCK # _____
 TIME MIXING BEGAN: _____ REV. @ PLANT, @ MIXING SPEED _____ PLANT AND LOCATION _____
 PLANT INSPECTOR: _____ MAX. WATER ALLOWED FOR THE MIX _____

| MATERIALS | * BATCH CHART TOTAL WEIGHT | TOLERANCE | * BATCH CHART TOTAL WEIGHT RANGE | | IF SINGLE OR DOUBLE BATCHED | | IF SINGLE BATCHED OR SUM OF DBL BATCH | MEETS BATCH CHART RANGE | | * FREE MOISTURE PERCENT | SSD WEIGHT ACTUAL ** BATCH WEIGHT DIVIDED BY (1+%(Moist.)) | TOTAL LBS WATER IN LOAD |
|--|----------------------------|-----------|----------------------------------|--------------|------------------------------|---------------------|---------------------------------------|-------------------------|----|-------------------------|--|--|
| | | | LOW - | HIGH + | ACTUAL BATCH WEIGHT (single) | ACTUAL BATCH WEIGHT | | YES | NO | | | |
| CEMENT, LBS. | | -1% | | | | | | | | | | |
| FLY ASH, LBS. | | -1% | | | | | | | | | | |
| SILICA FUME, LBS. | | -1% | | | | | | | | | | |
| TOTAL CEM. MATL. | | -1% | | | | | | | | | | FREE AGG. MOISTURE = ACT. BATCH WT. MINUS SSD WEIGHT |
| AGGREGATE (1) LBS | | +2% | | | | | | | | | | |
| AGGREGATE (2) LBS | | +2% | | | | | | | | | | |
| AGGREGATE (3) LBS | | +2% | | | | | | | | | | |
| TOTAL (1) + (2) + (3) | | | | | | | | | | | | |
| CRR. INHIB. GAL | | | | | | | | | | | | |
| METER WATER GAL | | | | | | | | | | | | |
| METER WATER LBS | | | oz / BAG | oz / 100 LBS | | | | | | | | |
| AIR ENT. AGENT, oz | | | | | | | | | | | | |
| WATER RED. AGENT, oz | | | | | | | | | | | | |
| WATER RED/RETARDED, oz | | | | | | | | | | | | |
| MR/HR WATER RED. RET. oz | | | | | | | | | | | | |
| * RATE TRUCK WASH WATER METER WATER LBS. = Max. Water Allowed for Site Additions GAL. LBS. TOTAL WATER AT PLANT = | | | | | | | | | | | | |
| CALCULATION OF WATER/CEMENTITIOUS MATERIAL RATIO: RATIO = TOTAL WATER IN LOAD (LBS) = _____ = _____ TOTAL CEM. MATL. (LBS) | | | | | | | | | | | | |
| 1st WATER ADDED AT SITE 2nd WATER ADDED AT SITE TOTAL WATER IN LOAD = (SUM) _____ LBS. | | | | | | | | | | | | |

COMMENTS: _____ MIXING REV. AT SITE: _____ REV. AFTER SITE WATER ADDED _____
 SLUMP: _____ ENTR. AIR %: _____ TOTAL oz _____ oz / 100 LBS
 CYLINDERS MADE (NO / YES): _____ ID #: _____ MINUTES _____
 TIME UNLOADING OF TRUCK ENDED: _____ CONCRETE TEMPERATURE @ PLACEMENT: _____ DEG. F _____

* FILL IN FOR 1st LOADS EACH DAY - THEN ONLY IF THERE IS A CHANGE.
 ** ADD 1.00 TO MOISTURE % (DECIMAL FORM)

FILE NO: _____ DATE: _____ CLASS _____ LOAD NO. _____ CU YDS _____ ACC. CY _____ TRUCK # _____
 TIME MIXING BEGAN: _____ REV. @ PLANT, @ MIXING SPEED _____ PLANT AND LOCATION _____
 PLANT INSPECTOR: _____ MAX. WATER ALLOWED FOR THE MIX _____

| MATERIALS | * BATCH CHART TOTAL WEIGHT | TOLERANCE | * BATCH CHART TOTAL WEIGHT RANGE | | IF SINGLE OR DOUBLE BATCHED | | IF SINGLE BATCHED OR SUM OF DBL BATCH | MEETS BATCH CHART RANGE | | * FREE MOISTURE PERCENT | SSD WEIGHT ACTUAL ** BATCH WEIGHT DIVIDED BY (1+%(Moist.)) | TOTAL LBS WATER IN LOAD |
|--|----------------------------|-----------|----------------------------------|--------------|------------------------------|---------------------|---------------------------------------|-------------------------|----|-------------------------|--|-------------------------|
| | | | LOW - | HIGH + | ACTUAL BATCH WEIGHT (single) | ACTUAL BATCH WEIGHT | | YES | NO | | | |
| CEMENT, LBS. | | -1% | | | | | | | | | | |
| FLY ASH, LBS. | | -1% | | | | | | | | | | |
| SILICA FUME, LBS. | | -1% | | | | | | | | | | |
| TOTAL CEM. MATL. | | -1% | | | | | | | | | | |
| AGGREGATE (1) LBS | | +2% | | | | | | | | | | |
| AGGREGATE (2) LBS | | +2% | | | | | | | | | | |
| AGGREGATE (3) LBS | | +2% | | | | | | | | | | |
| TOTAL (1) + (2) + (3) | | | | | | | | | | | | |
| CRR. INHIB. GAL | | | | | | | | | | | | |
| METER WATER GAL | | | | | | | | | | | | |
| METER WATER LBS | | | oz / BAG | oz / 100 LBS | | | | | | | | |
| AIR ENT. AGENT, oz | | | | | | | | | | | | |
| WATER RED. AGENT, oz | | | | | | | | | | | | |
| WATER RED/RETARDED, oz | | | | | | | | | | | | |
| MR/HR WATER RED. RET. oz | | | | | | | | | | | | |
| * RATE TRUCK WASH WATER METER WATER LBS. = GAL. X 8.33 = | | | | | | | | | | | | |
| Max. Water Allowed for Site Additions GAL. LBS. TOTAL WATER AT PLANT = | | | | | | | | | | | | |
| CALCULATION OF WATER/CEMENTITIOUS MATERIAL RATIO: RATIO = TOTAL WATER IN LOAD (LBS) = _____ = _____ TOTAL CEM. MATL. (LBS) | | | | | | | | | | | | |
| 1st WATER ADDED AT SITE 2nd WATER ADDED AT SITE TOTAL WATER IN LOAD = (SUM) = _____ LBS. | | | | | | | | | | | | |

COMMENTS: _____ MIXING REV. AT SITE: _____ REV. AFTER SITE WATER ADDED _____
 SLUMP: _____ ENTR. AIR %: _____ ADMIXTURE ADDED AT SITE: _____ TOTAL oz _____ oz / 100 LBS
 CYLINDERS MADE (NO / YES): _____ ID #: _____ MIXING TIME AFTER ADDING ADMIXTURE: _____ MINUTES
 TIME UNLOADING OF TRUCK ENDED: _____ CONCRETE TEMPERATURE @ PLACEMENT: _____ DEG. F

* FILL IN FOR 1st LOADS EACH DAY - THEN ONLY IF THERE IS A CHANGE.
 ** ADD 1.00 TO MOISTURE % (DECIMAL FORM)

FILE NO: _____ DATE: _____ CLASS _____ LOAD NO. _____ CU YDS _____ ACC. CY _____ TRUCK # _____
 TIME MIXING BEGAN: _____ REV. @ PLANT, @ MIXING SPEED _____ PLANT AND LOCATION _____
 PLANT INSPECTOR: _____ MAX. WATER ALLOWED FOR THE MIX _____

| MATERIALS | * BATCH CHART TOTAL WEIGHT | TOLERANCE | * BATCH CHART TOTAL WEIGHT RANGE | | IF SINGLE OR DOUBLE BATCHED | | IF SINGLE BATCHED OR SUM OF DBL BATCH | MEETS BATCH CHART RANGE | | * FREE MOISTURE PERCENT | SSD WEIGHT ACTUAL ** BATCH WEIGHT DIVIDED BY (1+%(Moist.)) | TOTAL LBS WATER IN LOAD |
|--|----------------------------------|-----------|--|--------------|---------------------------------------|---------------------------|--|----------------------------|----|----------------------------------|---|-------------------------|
| | | | LOW - | HIGH + | ACTUAL BATCH WEIGHT (single) | ACTUAL BATCH WEIGHT | | YES | NO | | | |
| CEMENT, LBS. | | -1% | | | | | | | | | | |
| FLY ASH, LBS. | | -1% | | | | | | | | | | |
| SILICA FUME, LBS. | | -1% | | | | | | | | | | |
| TOTAL CEM. MATL. | | -1% | | | | | | | | | | |
| AGGREGATE (1) LBS | | +2% | | | | | | | | | | |
| AGGREGATE (2) LBS | | +2% | | | | | | | | | | |
| AGGREGATE (3) LBS | | +2% | | | | | | | | | | |
| TOTAL (1) + (2) + (3) | | | | | | | | | | | | |
| CRR. INHIB. GAL | | | | | | | | | | | | |
| METER WATER GAL | | | | | | | | | | | | |
| METER WATER LBS | | | oz / BAG | oz / 100 LBS | | | | | | | | |
| AIR ENT. AGENT, oz | | | | | | | | | | | | |
| WATER RED. AGENT, oz | | | | | | | | | | | | |
| WATER RED/RETARDED, oz | | | | | | | | | | | | |
| MR/HR WATER RED. RET. oz | | | | | | | | | | | | |
| *RATE TRUCK WASH WATER METER WATER LBS. = GAL. X 8.33 = | | | | | | | | | | | | |
| Max. Water Allowed for Site Additions GAL. LBS. | | | | | | | | | | | | |
| TOTAL WATER AT PLANT = | | | | | | | | | | | | |
| CALCULATION OF WATER/CEMENTITIOUS MATERIAL RATIO: RATIO = TOTAL WATER IN LOAD (LBS) = _____ = _____ TOTAL CEM. MATL. (LBS) | | | | | | | | | | | | |
| 1st WATER ADDED AT SITE 2nd WATER ADDED AT SITE TOTAL WATER IN LOAD = (SUM) = _____ LBS. | | | | | | | | | | | | |

COMMENTS: _____ MIXING REV. AT SITE: _____ REV. AFTER SITE WATER ADDED _____
 SLUMP: _____ ENTR. AIR %: _____ ADMIXTURE ADDED AT SITE: _____ TOTAL oz _____ oz / 100 LBS
 CYLINDERS MADE (NO / YES): _____ ID #: _____ MIXING TIME AFTER ADDING ADMIXTURE: _____ MINUTES
 TIME UNLOADING OF TRUCK ENDED: _____ CONCRETE TEMPERATURE @ PLACEMENT: _____ DEG. F

* FILL IN FOR 1st LOADS EACH DAY - THEN ONLY IF THERE IS A CHANGE.
 ** ADD 1.00 TO MOISTURE % (DECIMAL FORM)

FILE NO: _____ DATE: _____ CLASS _____ LOAD NO. _____ CU YDS _____ ACC. CY _____ TRUCK # _____
 TIME MIXING BEGAN: _____ REV. @ PLANT, @ MIXING SPEED _____ PLANT AND LOCATION _____
 PLANT INSPECTOR: _____ MAX. WATER ALLOWED FOR THE MIX _____

| MATERIALS | * BATCH CHART TOTAL WEIGHT | TOLERANCE | * BATCH CHART TOTAL WEIGHT RANGE | | IF SINGLE OR DOUBLE BATCHED | | IF SINGLE BATCHED OR SUM OF DBL BATCH | MEETS BATCH CHART RANGE | | * FREE MOISTURE PERCENT | SSD WEIGHT ACTUAL ** BATCH WEIGHT DIVIDED BY (1+%(Moist.)) | TOTAL LBS WATER IN LOAD |
|--|----------------------------|-----------|----------------------------------|--------------|------------------------------|---------------------|---------------------------------------|-------------------------|----|-------------------------|--|--|
| | | | LOW - | HIGH + | ACTUAL BATCH WEIGHT (single) | ACTUAL BATCH WEIGHT | | YES | NO | | | |
| CEMENT, LBS. | | -1% | | | | | | | | | | |
| FLY ASH, LBS. | | -1% | | | | | | | | | | |
| SILICA FUME, LBS. | | -1% | | | | | | | | | | |
| TOTAL CEM. MATL. | | -1% | | | | | | | | | | FREE AGG. MOISTURE = ACT. BATCH WT. MINUS SSD WEIGHT |
| AGGREGATE (1) LBS | | +2% | | | | | | | | | | |
| AGGREGATE (2) LBS | | +2% | | | | | | | | | | |
| AGGREGATE (3) LBS | | +2% | | | | | | | | | | |
| TOTAL (1) + (2) + (3) | | | | | | | | | | | | |
| CRR. INHIB., GAL | | | | | | | | | | | | |
| METER WATER GAL | | | | | | | | | | | | |
| METER WATER LBS | | | oz / BAG | oz / 100 LBS | | | | | | | | |
| AIR ENT. AGENT, oz | | | | | | | | | | | | |
| WATER RED. AGENT, oz | | | | | | | | | | | | |
| WATER RED/RETARDED, oz | | | | | | | | | | | | |
| MR/HR WATER RED. RET. oz | | | | | | | | | | | | |
| * RATE TRUCK WASH WATER METER WATER LBS. = GAL. X 8.33 = | | | | | | | | | | | | |
| Max. Water Allowed for Site Additions GAL. LBS. | | | | | | | | | | | | |
| TOTAL WATER AT PLANT = | | | | | | | | | | | | |
| CALCULATION OF WATER/CEMENTITIOUS MATERIAL RATIO: RATIO = TOTAL WATER IN LOAD (LBS) = _____ = _____ TOTAL CEM. MATL. (LBS) | | | | | | | | | | | | |
| 1st WATER ADDED AT SITE 2nd WATER ADDED AT SITE TOTAL WATER IN LOAD = (SUM) _____ LBS. | | | | | | | | | | | | |

COMMENTS: _____ MIXING REV. AT SITE: _____ REV. AFTER SITE WATER ADDED _____
 SLUMP: _____ ENTR. AIR %: _____ ADMIXTURE ADDED AT SITE: _____ TOTAL oz _____ oz / 100 LBS
 CYLINDERS MADE (NO / YES): _____ ID #: _____ MIXING TIME AFTER ADDING ADMIXTURE: _____ MINUTES
 TIME UNLOADING OF TRUCK ENDED: _____ CONCRETE TEMPERATURE @ PLACEMENT: _____ DEG. F

* FILL IN FOR 1st LOADS EACH DAY - THEN ONLY IF THERE IS A CHANGE.
 ** ADD 1.00 TO MOISTURE % (DECIMAL FORM)

FILE NO: _____ DATE: _____ CLASS _____ LOAD NO. _____ CU YDS _____ ACC. CY _____ TRUCK # _____
 TIME MIXING BEGAN: _____ REV. @ PLANT, @ MIXING SPEED _____ PLANT AND LOCATION _____
 PLANT INSPECTOR: _____ MAX. WATER ALLOWED FOR THE MIX _____

| MATERIALS | * BATCH CHART TOTAL WEIGHT | TOLERANCE | * BATCH CHART TOTAL WEIGHT RANGE | | IF SINGLE OR DOUBLE BATCHED | | IF SINGLE BATCHED OR SUM OF DBL BATCH | MEETS BATCH CHART RANGE | | * FREE MOISTURE PERCENT | SSD WEIGHT ACTUAL ** BATCH WEIGHT DIVIDED BY (1+ %Moist.) | TOTAL LBS WATER IN LOAD |
|--|----------------------------|-----------|----------------------------------|--------------|------------------------------|---------------------|---------------------------------------|-------------------------|----|-------------------------|---|-------------------------|
| | | | LOW - | HIGH + | ACTUAL BATCH WEIGHT (single) | ACTUAL BATCH WEIGHT | | YES | NO | | | |
| CEMENT, LBS. | | -1% | | | | | | | | | | |
| FLY ASH, LBS. | | -1% | | | | | | | | | | |
| SILICA FUME, LBS. | | -1% | | | | | | | | | | |
| TOTAL CEM. MATL. | | -1% | | | | | | | | | | |
| AGGREGATE (1) LBS | | +2% | | | | | | | | | | |
| AGGREGATE (2) LBS | | +2% | | | | | | | | | | |
| AGGREGATE (3) LBS | | +2% | | | | | | | | | | |
| TOTAL (1) + (2) + (3) | | | | | | | | | | | | |
| CRR. INHIB. GAL | | | | | | | | | | | | |
| METER WATER GAL | | | | | | | | | | | | |
| METER WATER LBS | | | oz / BAG | oz / 100 LBS | | | | | | | | |
| AIR ENT. AGENT, oz | | | | | | | | | | | | |
| WATER RED. AGENT, oz | | | | | | | | | | | | |
| WATER RED/RETARDED, oz | | | | | | | | | | | | |
| MR/HR WATER RED. RET. oz | | | | | | | | | | | | |
| * RATE TRUCK WASH WATER METER WATER LBS. = GAL. X 8.33 = | | | | | | | | | | | | |
| Max. Water Allowed for Site Additions GAL. LBS. TOTAL WATER AT PLANT = | | | | | | | | | | | | |
| CALCULATION OF WATER/CEMENTITIOUS MATERIAL RATIO: RATIO = TOTAL WATER IN LOAD (LBS) = _____ = _____ TOTAL CEM. MATL. (LBS) | | | | | | | | | | | | |
| 1st WATER ADDED AT SITE 2nd WATER ADDED AT SITE TOTAL WATER IN LOAD = (SUM) = _____ LBS. | | | | | | | | | | | | |

COMMENTS: _____ MIXING REV. AT SITE: _____ REV. AFTER SITE WATER ADDED _____
 SLUMP: _____ ENTR. AIR %: _____ ADMIXTURE ADDED AT SITE: _____ TOTAL oz _____ oz / 100 LBS
 CYLINDERS MADE (NO / YES): _____ ID #: _____ MIXING TIME AFTER ADDING ADMIXTURE: _____ MINUTES
 TIME UNLOADING OF TRUCK ENDED: _____ CONCRETE TEMPERATURE @ PLACEMENT: _____ DEG. F

* FILL IN FOR 1st LOADS EACH DAY - THEN ONLY IF THERE IS A CHANGE.
 ** ADD 1.00 TO MOISTURE % (DECIMAL FORM)

LEVEL II: CONCRETE INSPECTION



SCDOT

UNIVERSITY OF
South Carolina

COVERED IN THIS SECTION

- Aggregate Sampling (SC-T-1 & SC-T-2)
- Standard Specifications 702
- Standard Specifications 703 & QPL 60
- Standard Specifications Appendix
- Construction Manual
- SCT Procedures

SCDOT

UNIVERSITY OF
South Carolina

AGGREGATE SAMPLING

Sampling is equally as important as the testing. Samples should show the true nature and condition of the materials that they represent.

Please refer to the applicable SC Test Procedures on the SCDOT website for sampling. Procedures for both coarse and fine aggregates have been recently revised.

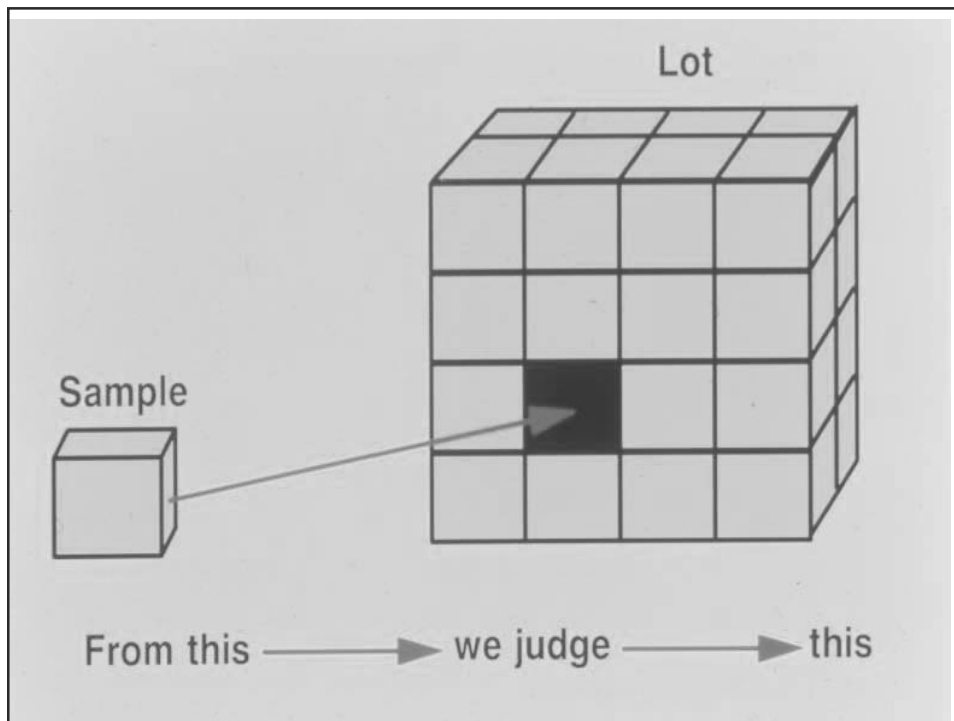

Methods of Sampling Coarse Aggregates SC-T-1

Samples can be taken from the following:

- Sample Pad / Stockpiles
- Truck dumps
- Storage Bins
- Conveyor belts
- Base samples are taken from roadway



SAMPLE SIZES

The required minimum size of the sample is listed in the appropriate test procedures:

SC-T-1: Coarse Aggregates

SC-T-2: Fine Aggregates

| Type of Aggregate | Minimum Weight of Field Samples (pounds) |
|--|--|
| Coarse Aggregates (5, 57, 67, 789, etc) | 40 |
| Aggregate Base (Macadam, MLBC, RPCC) | 70 |
| Fine Aggregates | 20 |



SAMPLING FROM SAMPLE PAD

- Create sample pad with loader by taking 2 buckets of material and dumping together, mixing, and back dragging to $\frac{1}{2}$ original height
- Divide pad into four quadrants and take one full shovel of material from each quadrant
- If additional material is needed, take an additional portion from center of the pad



SAMPLING FROM SAMPLE PAD

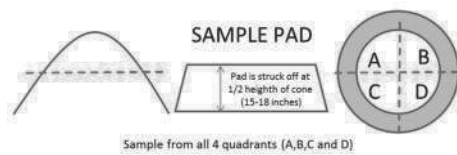

SAMPLING FROM STOCKPILES

- Take first portion approximately 3 feet above ground.
- Move laterally and take second portion approximately 6 feet above ground.
- Move laterally and take third portion approximately 9 feet above ground.
- If additional material is needed take another portion from center location.

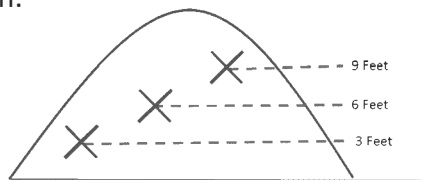

SAMPLING FROM STOCKPILES
Figure SC-T-1B



SAMPLING FROM A TRUCK DUMP

- Least preferred method.
- Do not sample if material has already been removed.
- Use a loader to remix and form a sample pad if loader is available.

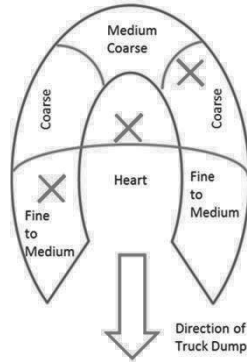

SCDOT

UNIVERSITY OF
South Carolina

SAMPLING FROM CONVEYOR BELTS

- Sample is 3 portions
- Scrape clean at least 2 feet of belt
- Allow belt to make 2 revolutions between portions



SCDOT

UNIVERSITY OF
South Carolina

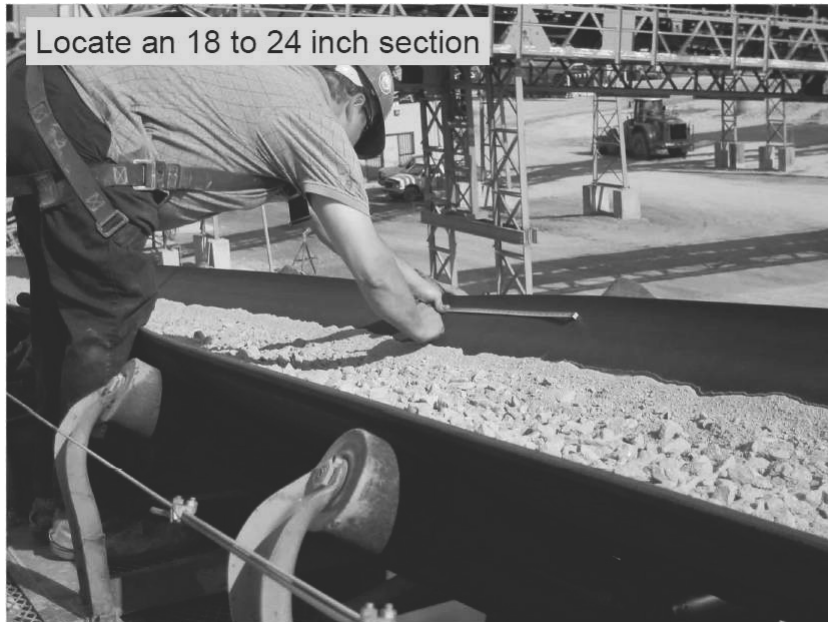





SAMPLING FROM STORAGE BINS

- Permit sufficient flow before taking sample to ensure that flow is uniform.
- Sample entire cross section of flow.



SAMPLING BASE FROM ROADWAY

- Sample locations determined by random sampling. 1st location is job control sample, 2nd and 3rd locations are check samples.
- Sample by taking 3 portions for full depth of layer, one from near centerline and one approx. 2 feet from either edge.
- Combine portions to form one sample.



Sampling Fine Aggregates SC-T-2

Samples can be taken from the following:

- Stockpile
- Conveyor Belt

Sample Handling and Contamination

How can you contaminate a sample?

- Improper or mishandling
- Improper sampling procedures example:
Stockpiles – should not overlap



Chapter 8

SCDOT 2007 Standard Specifications for Highway Construction

Section 702: Concrete Structures

Section 702 – Concrete Structures

702 Plus

Appendix A: 4 - 7

STANDARD SPECIFICATIONS: 702 CONCRETE STRUCTURES

(CHAPTER 8)



702 LAYOUT – CONTRACTOR'S POINT OF VIEW

- Raw Materials
- Equipment to Place
- Formwork and Falsework Design and Installation
- Concrete Placement
- Curing
- Repairs
- Finishes and Joints



702.2 MATERIALS

702.2.1 – 2.13 Material Requirements

Covers: Concrete, Expansion Joint Materials,
Liquid Curing Compounds, Falsework, & Forms

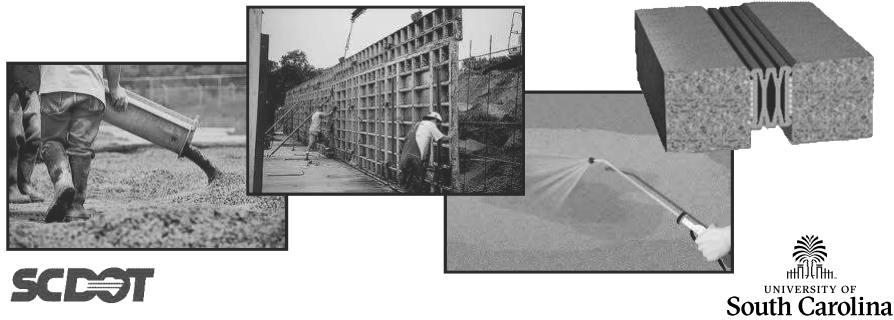

Liquid Curing Compounds **MUST**
be on Current QPL.



SCDOT

UNIVERSITY OF
South Carolina

702.3 EQUIPMENT

702.3.1 – 3.4 Material Requirements

Covers: **Vibrators, Tremmies, Kettles, and Curing Blankets**



SCDOT

UNIVERSITY OF
South Carolina

Backup Vibrators are a MUST!



SCDOT

UNIVERSITY OF
South Carolina

702.4 CONSTRUCTION

702.4.1.1 – 1.8 Falsework/forming Systems

Covers: Design, Drawings, Inspection, Construction and Approval of Wooden, Metal and Stay in Place Forms



Formwork



Formwork can control the final finish of the element



SCDOT

UNIVERSITY OF
South Carolina

SIP Forms



SCDOT

UNIVERSITY OF
South Carolina

False Work and Forms



702.4.2 HANDLING & PLACING PCC

702.4.2.1-2.8

Covers: General Practice, Construction Joints, Pumping and Vibration, Mass Concrete Placement, Depositing Underwater, Exposure to Tidal Water, and Temperature Control

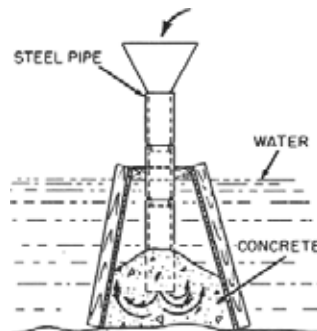

Depositing Concrete Underwater

QUESTION: What class of concrete is specified in the Standard Specifications for depositing concrete underwater?



SCDOT

UNIVERSITY OF
South Carolina

Hot & Cold Weather Concrete



*****See Chapter 5 for New Supplemental Specifications regarding new Hot & Cold Weather Plans for jobs Let 7/1/2018 and after.**

Diaphragms and Beam Pockets Need to be Checked before Placement of Cleanliness



SCDOT

UNIVERSITY OF
South Carolina

702 CONCRETE STRUCTURES

- **702.4.3** Setting Final Grade of Bridge Deck Slabs
- **702.4.4** Concrete Curing
 - **702.4.4.1** Bridge Decks
 - **702.4.4.2** Structural o/t Bridge Decks
- **702.4.5** Falsework/Form Removal
- **702.4.6** Protecting/Loading New PCC
- **702.4.7** Initial Surface Finish

SCDOT

UNIVERSITY OF
South Carolina

Falsework/Form Removal

QUESTION: What strength does the concrete need to be in order for the falsework and forms to remove under slabs, beams, girders, caps, arches, and structures or parts of structures carrying static dead loads?



702 CONCRETE STRUCTURES

702.4.8 – 4.12 Repairs

Covers: Repairs of Surface Defects, Repairs of Cracks in the Top Surfaces of Bridge Decks, Repairs of the Top Surfaces of Bridge Decks, Final Finish of Exposed PCC Surfaces o/t Bridge Decks, Limits of Initial & Final Finishes



702 CONCRETE STRUCTURES

- **702.4.13** Treatment of Horizontal Surfaces not Subject to Wear
- **702.4.14** Bridge Deck Rideability
- **702.4.15** Grinding/Texturing BD's
- **702.4.16** Grooved Surface Finish
- **702.4.17** Finishing of Joints
- **702.4.18** Encased/Supported Pipes and Conduits
- **702.4.19** Weeping Holes and Drains
- **702.4.20** Bridge Sidewalks & Curbs
- **702.4.21** Widening Existing Structures



Concrete Deck Placement



Concrete Deck Placement

QUESTION:

Bridge Deck requires a dry run: What is the maximum distance between measurements?



Repair of Bridge Decks

QUESTION:

How does SCDOT define a “large” defective area on a bridge deck?



SECTION 702

CONCRETE STRUCTURES

702.1 Description

1. This section contains specifications for the materials, equipment, construction, measurement, and payment for structures involving the use of structural concrete, except where the requirements are specifically waived or revised by another governing section of these specifications. Construct concrete structures in accordance with the design requirements and details shown on the Plans and in conformity with the requirements of this specification and any Special Provisions pertaining thereto.

702.2 Materials

702.2.1 Concrete

1. Provide concrete conforming to the requirements of **Section 701**. Provide the class of concrete for each type of structure, structural element, or concrete item as specified herein and on or in the Plans, *SCDOT Standard Drawings*, Supplemental Specifications, the Special Provisions, or as directed by the RCE.

702.2.2 Expansion Joint Material

702.2.2.1 Preformed Joint Filler

1. Use preformed material composed of cane or other fibers of a cellular nature, securely bound together, uniformly saturated with a suitable bituminous binder, and complying with the requirements of AASHTO M 213, or a preformed material composed of 100% scrap tire rubber that is shredded and fused into cohesion with a non-toxic, odorless, and tasteless formulated polyurethane binder. Make certain that the shreds are treated to resist most types of microbes, oils, fungi, and biological growth. Provide joint filler meeting the physical properties of ASTM D 6690, Type I.

702.2.2.2 Hot-Poured Elastic Filler

1. Provide hot-applied elastic filler material meeting the requirements of ASTM D 6690, Type I.
2. Make certain that the filler material does not exceed the maximum of 20% recycled tire rubber by weight of bituminous components. When using material with scrap tire rubber, obtain a certified statement from the vendor with each shipment stating the number of pounds of reclaimed scrap tire rubber contained in the filler material. Provide the certificate to the RCE before using the filler material.

702.2.2.3 Elastomeric Compression Seals for Bridge Decks

1. Use elastomeric compression seals for bridge deck joints meeting the requirements of AASHTO M 297. Provide seals that conform to the dimensions shown on the Plans. Ensure that the lubricated adhesive used with the seals meets the requirements of ASTM D 2835. Install the seals in accordance with the manufacturer's recommendations or as directed by the RCE. Do not splice or cut the seal unless indicated to do so on the Plans.
2. Obtain from the vendor and furnish to the RCE three copies of the manufacturer's certification of conformance along with test results verifying that the seals and adhesive furnished meet the applicable specifications.

702.2.2.4 Metal Expansion Plates

1. Provide stainless steel plates, Type 301 or Type 302, with a No. 1 Finish as specified in ASTM A 167. If copper alloy expansion plates are required, use copper alloy No. 510 as specified in ASTM B 100.

702.2.2.5 Roofing Felt

1. Use a standard self-adhesive roofing underlayment with at least a 60 mil. thickness.

702.2.2.6 Copper Flashing

1. Use flashing of the thickness or weight indicated for Copper No. 110 as specified in ASTM B 152.

702.2.2.7 Plastic Waterstops

1. Provide flexible polyvinyl chloride waterstops of the size and type specified on the Plans. Unless otherwise specified, use material conforming to the current *AASHTO LRFD Bridge Construction Specifications*, Section 8.9.2.6.2.

702.2.2.8 Pipes and Conduits

1. If polyvinyl chloride (PVC) pipe schedule 40, 80, or 120 is used for conduit, ensure that it meets the requirements of ASTM D 1785.

702.2.2.9 Cold Applied Elastic Filler

1. Provide polymeric elastomeric, two-component, cold-applied, bridge joint filler recommended by the manufacturer for use in bridge joints and meeting the requirements of ASTM C 920 for a multiple component self-leveling material.
2. When specified or as an alternate to the abovementioned filler, use a self-leveling, cold-applied, rapid cure, two-part, ultra low modulus, 100% silicone rubber sealant. Provide this material packaged such that no pre-mixing or measuring is required. Use sealant capable of accommodating movements up to $\pm \frac{1}{2}$ inch for bridge joints 1 to 3 inches wide. Check throat depth immediately before and during installation. Have a manufacturer's representative on site during the first installation.
3. Provide circular cross-section backer rod consisting of closed-cell, polyethylene foam that is $\frac{1}{8}$ inch greater in diameter than the maximum joint width.
4. Use material from sources appearing on the most recent edition of *SCDOT Qualified Product List 11*.

702.2.2.10 Bridge Deck Joint Strip Seals

1. Provide bridge deck joint strip seals complying with the requirements of **Section 723**.

702.2.2.11 Liquid Curing Compounds

1. Unless otherwise specified, use Type 2, white pigmented, liquid curing compounds conforming to AASHTO M 148 either Class A all resin or all wax based, or Class B all resin based. Ensure that all products are VOC compliant (water-based or solvent-emulsion). Do not use total solvent-based products.
2. When tested in accordance with AASHTO T 155 procedures, small oven variations will be allowed in temperature, relative humidity, and velocity of air current.

3. Use materials from sources appearing on the most recent edition of *SCDOT Qualified Product List 33*.
4. For each project, provide the RCE with the following documents:
 - Certificate of analysis and performance test results for each lot/batch number furnished, verifying that it meets AASHTO M 148 for the type and class furnished.
 - Materials Safety Data Sheet.
 - Application instructions.

The following information only needs to be furnished to the RCE once provided there are no manufacturing changes to the material.

5. Ensure that the shipping containers are plainly marked with the manufacturer's name and trademark, batch number, type and class of cure, and date of manufacture. With each load of material shipped in bulk tankers, provide a label and place it on the project storage tank for identification purposes.
6. The RCE and OMR will accept the material based on a manufacturer's certificate of analysis and performance test results, the fact that it is on the most recent edition of *SCDOT Qualified Product List 33*, and is delivered in properly labeled containers.
7. The above acceptance procedures will be honored by the Department until the documentation of the curing compound is found to be incorrect. If this condition should occur, the OMR will attempt to establish correct documentation. Results of these negotiations and/or tests will be used to determine the future status of the manufacturer as an authorized source.

702.2.2.12 Falsework

1. Submit to the BCE detailed Working Drawings and design calculations for falsework in accordance with **Subsection 105.2** and **Section 725** for work involving cofferdams; structures over navigable waterways, highways, or railroads; caps adjacent to railroads or highways; temporary shoring walls; cast-in-place flat slabs or girders/beams; and any other items designated on the Plans or in the Special Provisions as requiring falsework.
2. Ensure that the Working Drawings and design calculations submitted as described above are sealed by a South Carolina registered Professional Engineer and comply with the requirements of **Subsection 702.4.1**. Working Drawings and design calculations will not be reviewed in-depth by the Department, and review or acceptance of Working Drawings and design calculations does not relieve the Contractor of the responsibility for the adequacy of the falsework.
3. If a falsework system has been previously used successfully on an SCDOT project, Working Drawings for that system are not required to be re-submitted to the BCE, but instead submit to the RCE for verification purposes, two copies of the Working Drawings for the previously accepted falsework system that have been stamped by the BCE. No deviations will be allowed to this previously accepted system without the approval of the BCE. If there are changes to the system, submit to the BCE for review and acceptance, the details of the changes along with calculations sealed by a South Carolina registered Professional Engineer.

702.2.2.13 Forms

1. Submit detailed Working Drawings for forms involving items of work listed in **Subsection 702.2.2.12** in accordance with **Subsection 105.2** and **Section 725**. Make certain that the Working Drawings are sealed by a South Carolina registered Professional Engineer and comply with the requirements of **Subsection 702.4.1.3**. Working Drawings will not be reviewed in-depth by the Department, and review or acceptance of Working Drawings does not relieve the Contractor of the responsibility for the adequacy of the forms.
2. If a form system has been previously used successfully on an SCDOT project, Working Drawings for that system are not required to be re-submitted to the BCE. Submit to the RCE for verification purposes, two copies of the Working Drawings for the previously accepted form system that have been stamped by the BCE. No deviations will be allowed to this previously accepted system unless the changes, sealed by a South Carolina registered Professional Engineer, are resubmitted to the BCE for review and acceptance.
3. Use forms made of wood or metal that are mortar-tight and of sufficient rigidity to prevent distortion due to the pressure of the concrete and other loads incident to the construction operations. Make certain that the interior dimensions of the forms conform to the shape and dimensions of the finished concrete as shown on the Plans. Construct and maintain forms to prevent warping and opening of joints due to expansion or shrinkage of the forms. Ensure that the forms are substantial and unyielding and the design includes the effect of vibration of concrete and the impact of concrete as it is placed.
4. Use dressed lumber or plywood in wood forms. Ensure that the dressed lumber is of good quality and free of imperfections that would affect the strength or impair the finished surface of the concrete. Repair all mismatched forms, holes, or undesirable indentions in the forms to the satisfaction of the RCE before placing concrete.

702.3 Equipment

702.3.1 Vibrators

1. Use vibrators that are in good operating condition and are acceptable to the RCE. Provide an adequate number of working backup vibrators for each pour and backup sources of power throughout the pour, such that backups are available in event of failure of any of the required vibrators. Do not begin a concrete pour if not in compliance with this requirement.
2. Use the minimum number of vibrators for a pour based on the size of the batches, the frequency of batches, the size of the sections, and the size of the vibrators subject to acceptance by the RCE.

702.3.2 Tremie

1. If a tremie is used in depositing concrete under water, use one that consists of a metal tube, other than aluminum, and has a diameter of not less than 10 inches. Use a tremie constructed in sections having flanged couplings fitted with watertight gaskets.

702.3.3 Kettles for Heating Hot-Poured Elastic Filler

1. In order to avoid damaging hot poured elastic filler material by excessive heating, melt the filler material in a double-walled, oil-bath kettle. Provide an accurate pyrometer to accurately measure the heat of the filler material in accordance with the manufacturer's instructions.

702.3.4 Curing Blankets

1. Use curing blankets of a natural or synthetic fiber-polyethylene mat or other material expressly manufactured for curing concrete. Make certain that the exposed side is a white opaque polyethylene.

702.4 Construction

702.4.1 Falsework/Forming Systems

702.4.1.1 General

1. Apply the requirements of this subsection to all falsework/forming systems, including systems for flat slabs, cast-in-place girders/beams, reinforced concrete decks, bent or pier caps, reinforced concrete columns, cofferdams, sheeting or shoring, temporary work bridges, and any other temporary systems to support the structure, soil in excavations, embankments, personnel, or equipment during the construction of the project. Refer to **Subsections 702.2.2.12** and **702.2.2.13** for special submittal requirements.

702.4.1.2 Design

1. Design falsework/form systems to handle all vertical and horizontal loading that may be placed upon it and with sufficient redundancy to prevent failure of the system because of the failure of any individual element. Include the sum of all anticipated vertical dead and live loads and real and assumed horizontal loads. Include the weight of the concrete, reinforcing steel and other encased items, equipment, personnel, forms, and falsework. For the weight of concrete, do not use less than 150 pounds per cubic foot for normal concrete and not less than 120 pounds per cubic foot for lightweight concrete.
2. For live loads, use the actual weight of any equipment and personnel to be supported by falsework applied as concentrated loads at the points of contact plus a uniform load of not less than 20 pounds per square foot applied over the area supported, plus 75 pounds per linear foot applied at the outside edge of deck overhangs.
3. For horizontal loads, use actual horizontal loads due to equipment and personnel, construction sequence, or other causes, plus an assumed horizontal wind load of not less than 50 pounds per square foot of horizontal surface area or 2% of the total dead and live load, whichever is greater.
4. Erect falsework with sufficient camber and/or adjustment to compensate for deflection and settlement under the weight of concrete so that the completed structure or part thereof has the alignment and curvature shown in the Plans. When footing type foundations are used for falsework support, determine the bearing value of the soil and show the values assumed in the design on the Working Drawings. Consider the effects of differential settlement. Limit settlement and support of falsework to 1 inch or less.
5. When falsework is to be placed adjacent to public roads, consider the effects of vibrations from passing vehicles and include provisions for protection of the falsework from errant vehicles.
6. If falsework from one bridge is to be used on another bridge, determine new loading conditions and verify the adequacy of the falsework system. Incorporate into the design any adjustments or changes necessary.

702.4.1.3 Working Drawing Submittal

1. Provide fully detailed Working Drawings showing the layout of false-work/form elements, sizes, material specifications, and any manufacturer's recommendations for installation. Show allowable stresses for design, working loads, the load capacity of all support elements, and the design specifications. Refer to **Subsections 702.2.2.12** and **702.2.2.13** for special submittal requirements.

702.4.1.4 Inspection

702.4.1.4.1 General

1. Install falsework/form systems in accordance with the submitted, reviewed, and accepted Working Drawings. Do not deviate from these drawings. Properly install clean, lubricated bolts in all bolted connections. Have the installation of falsework/forms inspected as required by **Subsection 702.4.1.4.2** or **702.4.1.4.3**. Correct all deficiencies found during the inspection to the satisfaction of the Contractor's qualified inspector and the RCE before loading the falsework system.

702.4.1.4.2 Category I

1. Have a South Carolina registered Professional Engineer, employed or retained, inspect the initial assembly and installation of the falsework/form system required for structural items listed in **Subsections 702.2.2.12** and **702.2.2.13**, or as otherwise specified on the Plans or in the Special Provisions for compliance with the accepted and approved falsework/form system except for bridge deck overhangs and cofferdams or sheeting with a design height of 8 feet or less. Provide the RCE with a written certification of compliance from the Contractor's designated qualified inspector before loading the system.
2. Have additional installations of the identical falsework system on the project inspected by a South Carolina registered Professional Engineer or the Contractor's designated qualified inspector. Provide the RCE with a written certificate of compliance with the accepted Working Drawings before loading the system.

702.4.1.4.3 Category II

1. Have falsework/form systems for bridge deck overhangs and cofferdams or sheeting with a design height of 8 feet or less and all other systems not covered by Category I above inspected by the Contractor's designated qualified Inspector to ensure that the assembly and installation of the system is in accordance with the accepted falsework/form Working Drawings. If in the opinion of the RCE a system may not be assembled or installed in accordance with the accepted Working Drawings, provide an inspection and a written certificate of compliance by a South Carolina registered Professional Engineer for the system in question.

702.4.1.4.4 Designated Inspector Qualifications

1. Provide the RCE with the name and qualifications of the Contractor's designated qualified inspector. Make certain that the inspector has a minimum of 5 years of supervisory experience in bridge construction or an Engineering degree and 4 years experience in structural design or bridge construction.

702.4.1.4.5 Responsibility

1. The Contractor is not relieved of any liability or responsibility based on the Department's review of falsework/form system designs and drawings. The Contractor is solely responsible for the adequacy of the installation and performance of the falsework/form system. Any delays due to failure to comply with this specification or due to the inadequacy of the proposed false-work/form system are not grounds for an extension of contract time or additional compensation.

702.4.1.5 Wood Forms

1. Use machined surface chamfer strips to form fillets on concrete member of the size and at the locations shown on the Plans. Design and construct forms such that they may be removed without injuring the concrete.
2. Ensure that metal anchors, bolts, struts, reinforcement, ties, etc., encased in the concrete are placed such that no metal remains closer than 1 inch to the surface of the concrete. Wire form-ties of special design with a weakened section not less than $\frac{3}{4}$ inch back from the concrete face may be used at places of minor pressure, provided such ties have $\frac{3}{4}$ -inch deep wooden or plastic cone nuts to ensure the breaking of the tie at least $\frac{3}{4}$ inch inside the face of the concrete. Do not use wire ties in forms other than those described above. Other devices may be submitted for consideration, but do not use them without the written approval of the BCE.
3. Roughen cavities left by washers, cone nuts, or falsework/form support systems, and then completely plug, without any voids, with non-shrink structural grout approved by the RCE. If the grout plug shows a crack after setting, remove it and re-plug the cavity. Float the plugged surface flush with the adjacent surface. Ensure that the texture and color of the plugged surface is similar to the surrounding surface.
4. Other devices may be submitted for consideration, but do not use them without the written approval of the BCE.

702.4.1.6 Metal Forms

1. When using metal forms, comply with the specifications for wood forms regarding design, mortar-tightness, fillets and chamfers, bracing, alignment, removal, re-use, and oiling. Use metal in forms of such thickness that the forms will remain true to shape. Countersink all bolts and rivet heads on the formed surface. Design clamps, pins, or other connecting devices to hold the forms rigidly together and to allow removal without injury to the concrete. Do not use metal forms that do not present a smooth surface or do not line up properly. Exercise special care to keep metal forms free from rust, grease, or other foreign matter that may discolor the concrete. Provide metal forms with an adjustable metal section or occasional sections where wooden forms may be inserted to compensate for inaccuracies in measurements.

702.4.1.7 Stay-in-Place (SIP) Forms for Concrete Deck Slabs

1. If allowed in the Plans, permanent stay-in-place steel bridge deck forms for concrete deck slabs may be used at the Contractor's option. If used, make certain that the forms comply with the requirements for SIP forms contained herein.

702.4.1.7.1 Material for SIP Forms

1. Fabricate permanent steel bridge deck forms and supports from steel conforming to ASTM A 446/A 653, Grades 40 or 50, and having a coating class of G165 in accordance with ASTM A 525.

702.4.1.7.2 Design of SIP Forms

702.4.1.7.2.1 Loads for SIP Forms

1. Base design of SIP steel forms on dead load of forms, reinforcement, and plastic concrete plus 50 pounds per square foot for construction loads. Limit allowable unit working stress in the steel sheet to not more than 72.5% of the specified minimum yield strength of the material furnished. In any case, do not exceed 36,000 psi.

702.4.1.7.2.2 Deflection of SIP Forms

1. Calculate deflections using the weight of the forms, the plastic concrete, and reinforcement. In any case, do not use a loading of less than 120 pounds per square foot total for deflection calculations. Consider vibration effects from adjacent traffic, construction activities, etc. in the deflection calculations. For form span lengths less than or equal to 10 feet, do not allow deflections to exceed 1/180 of the form span length or ½ inch, whichever is less. For form span lengths greater than 10 feet, do not allow deflections to exceed 1/240 of the form span length or ¾ inch, whichever is less.
2. Base the permissible form camber on the actual dead load condition. Do not use camber to compensate for deflection in excess of the limits in paragraph 1 above.

702.4.1.7.2.3 Span Length of SIP Forms

1. Use the clear span distance of the form plus 2 inches measured parallel to form flutes as the design span length for forms.

702.4.1.7.2.4 Design Properties of SIP Forms

1. Compute the physical design properties in accordance with requirements of the current edition of the AISC specification *Design of Cold Formed Steel Structural Members*.

702.4.1.7.3 Reinforcing Steel in SIP Forms

1. Make certain that the bottom mat of reinforcing steel in SIP forms has minimum concrete cover of 1 inch. Maintain the plan dimensions of both layers of primary deck reinforcement from the top surface of the concrete deck.

702.4.1.7.4 Lateral Bracing for SIP Forms

1. Do not consider permanent steel bridge deck forms as lateral bracing for compression flanges of supporting structural members.

702.4.1.7.5 Longitudinal Deck Joints for SIP Forms

1. Unless authorized in writing by the BCE, do not use permanent steel bridge deck forms in bays in which longitudinal deck construction joints are located.

702.4.1.7.6 Welding of SIP Forms

1. Do not weld SIP forms to beam or girder flanges or other structural steel bridge elements, unless specified and the approved on Shop Plans.

702.4.1.7.7 Shop Plans for SIP Forms

1. Submit Shop Plans in accordance with **Section 725**. On the Shop Plans, indicate the grade of steel, the physical and section properties for all permanent steel bridge deck form sheets and details of form support devices.

702.4.1.7.8 Construction with SIP Forms

1. Prepare *Fabrication and Erection Plans* for SIP forms and submit them in accordance with **Section 725**. Install all forms in accordance with accepted *Fabrication and Erection Plans*.
2. Do not rest forms directly on the top of the stringer or floor beam flanges. Securely fasten form-to-form supports and provide a minimum bearing length of 1 inch at each end. Place form supports in direct contact with the flange of stringer or floor beam. Attach the form to the support by permissible welds, bolts, clips, or other approved means. However, welding of form supports directly to flanges is not permitted.
3. Where the galvanized coating of permanently exposed form metal has been damaged, thoroughly wire brush and clean the damaged metal to the satisfaction of the RCE, then paint with two coats of zinc oxide and zinc dust primer in accordance with ASTM A 780 with no color added. Minor heat discoloration in areas of welds need not be touched up.
4. Locate transverse construction joints at the bottom of a form flute. Field drill ¼-inch weep holes at not less than 12 inches on-center along the line of the joint.

702.4.1.7.9 Placing Concrete in SIP Forms

1. Place concrete in accordance with the manufacturer's recommendations and the Special Provisions. Make certain that the proper vibration of the concrete is performed to avoid honeycombing and voids especially at construction joints, expansion joints, and valleys and ends of form sheets.

702.4.1.7.10 Inspection of SIP Forms

1. Provide such facilities as are reasonable for the RCE to a conduct safe and convenient inspection of the SIP forms.
2. The Contractor's method of construction will be carefully observed during all phases of the construction of the bridge deck slab. These phases include installation of the metal forms, location and fastening of the reinforcement, composition of concrete items, mixing procedures, concrete placement and vibration, and finishing of the bridge deck. Should the RCE determine that the procedures used during the placement of the concrete warrant inspection of the underside of the deck, remove at least one section of the forms at a location and time selected by the RCE for each span. Perform this removal as soon after placing the concrete as practicable in order to provide visual evidence that the concrete mix and the placement procedures are obtaining the desired results. Remove additional sections if the RCE determines any change in the concrete mix or placement procedures warrant additional inspection.
3. After the deck concrete has been in place for a minimum of 2 days, test the concrete for soundness and bonding of the forms by sounding with a hammer as directed by the RCE or BCE. If areas of doubtful soundness are disclosed by this procedure, remove the forms from such areas for visual inspection after the concrete has attained adequate strength. Perform this removal of the permanent steel bridge deck forms at no cost to the Department.

4. Unless otherwise directed, do not replace the forms at locations where sections of the forms are removed, but repair the adjacent metal forms and supports to present a neat appearance and ensure their satisfactory retention.
5. As soon as the form is removed, examine the concrete surfaces for cavities, honeycombing, and other defects. If irregularities are found and it is determined by the RCE that these irregularities do not justify rejection of the work, repair the concrete as directed by the RCE and give an initial surface finish in accordance with these specifications. If the concrete where the form is removed is unsatisfactory, remove additional forms as directed by the RCE for inspection. Remove or repair all unsatisfactory concrete as directed by the BCE. Modify the method of construction to obtain satisfactory concrete in un-poured slabs.
6. If after a substantial amount of slab has been satisfactorily constructed and inspected and the results of the inspection as outlined above indicate that sound concrete is being obtained throughout the slabs, the RCE may moderate the amount of sounding and form removal.

702.4.1.8 Construction of Falsework/Form Systems

1. Set all wood and metal forms as outlined in **Subsections 702.4.1.5** and **702.4.1.6** and maintain forms true to the line and grade with no mismatched forms or holes/indentions in forms until the concrete has gained sufficient strength to permit their removal. Install permanent steel bridge deck forms for concrete deck slabs in accordance with **Subsection 702.4.1.7**. If before or during the placing of concrete, the forms appear to be unsatisfactory in any way, the RCE will stop all work on the project until the defects have been corrected.
2. Do not place forms in patchwork arrangement by using small pieces. Stagger joints in lumber other than plywood.
3. For narrow walls, columns, etc., where the bottom of the forms or construction joint is inaccessible, leave the lower form boards loose, so they can be removed for cleaning out extraneous material immediately before placing the concrete, or provide suitable openings and methods of closing for this purpose.
4. Except for permanent steel bridge deck forms, treat forms with oil or saturate with water immediately before placing the concrete. For rail members or other members with exposed faces, treat the forms with approved oil to prevent the adherence of concrete. Do not use any material that adheres to or discolors the concrete.
5. Inspect forms before as well as during the placement of concrete. Check all dimensions carefully and make certain that any errors, bulges, warping, or other defects are remedied before concrete is placed.
6. Ensure that the back face of forms for cast-in-place box girders are free of screw heads, protruding nails, and any other objects that would hinder inspection of the inside of the box girder.

702.4.2 Handling and Placing Concrete

702.4.2.1 General

1. Place concrete only during daylight hours unless otherwise specified, allowed or required by the Contract or approved by the RCE. Do not start the placing of concrete unless the pour can be completed and the concrete finished during daylight, except when an adequate lighting system is provided and the pour is accepted by the RCE.

2. Do not place concrete until the following items have been inspected by the RCE:
 - Depth, character, and water conditions of foundations in water,
 - Adequacy of falsework and forms,
 - Absence of debris in the forms,
 - Alignment and grade of the forms,
 - Condition of the construction joints, and
 - Condition and spacing of the reinforcing steel.
3. Unless authorized in writing by the BCE, do not place concrete before the RCE receives notification from the OMR or an OMR authorized AASHTO accredited testing laboratory that all reinforcing steel in the affected pour meets the contract requirements.
4. Do not deposit concrete under water unless permitted by the Plans or the Special Provisions or is authorized in writing by the BCE.
5. Provide sufficient hauling equipment to permit continuous placing of concrete, to maintain required pour rates, and to prevent placing of concrete on or against previously placed concrete that has begun its initial set in any one pour.
6. Establish a concrete operation with job site placement of concrete at a minimum rate of 25 cubic yards per hour, unless specified otherwise on the Plans or in the Special Provisions. For bridge deck slabs, establish the concrete placement at a minimum rate of 45 cubic yards per hour with a maximum pour time of 5 hours unless otherwise authorized in writing by the BCE. Before the first concrete deck pour, hold a Pre-pour Conference with the concrete supplier and the RCE to establish a *Concrete Operation Plan*. Prepare and submit this written plan to and have it accepted by the RCE before pouring any deck concrete. The RCE is not required to review the plan in-depth, and the Contractor assumes all responsibility for the adequacy of the plan. Hold additional conferences when necessary or if directed by RCE.
7. Regulate placing concrete so that the pressures caused by wet concrete do not cause distortion of the forms.
8. Conduct the operation of depositing and compacting the concrete to form an artificial stone of maximum density and impermeability and uniform texture with smooth surfaces when the forms are removed.
9. Deposit concrete so that the total deflection or settlement of supporting members and the final screeding of the surface has occurred before initial set of the concrete.
10. Place concrete while fresh and before initial set has occurred. Do not use or re-temper concrete in which initial set has begun. Do not, in any case, re-temper concrete. Do not use concrete containing lumps or crusts of hardened materials. If any concrete is found defective, remove or repair it as specified herein or as directed by the BCE without extra compensation.
11. Do not retain concrete that has not reached its final position in the forms within 75 minutes after water or cement is first added to the mix, except when an approved water reducing retarder is used. If a water reducing retarder is used, the maximum time may be extended to 2 hours.
12. Place concrete to avoid segregation of the materials and displacement of the reinforcement. Obtain written permission from the BCE to use chutes over 50 feet in length for conveying concrete from the mixer to the forms. If an inferior quality of concrete is produced by the use of chutes, employ an alternate method of placing concrete that is satisfactory to the BCE.

13. Use open metal troughs, pipes, and chutes or metal lined (other than aluminum) troughs, pipes, and chutes. Where steep slopes are necessary, equip the chutes with baffle boards or use short lengths of chutes that change the direction of movement.
14. Keep all chutes, troughs, and pipes clean and free from coatings of hardened concrete by thoroughly flushing with water after each run. Discharge the water used for flushing away from the concrete in place.
15. Except in the fabrication of prestressed concrete members, drilled piles, and drilled shafts, do not drop concrete more than 5 feet unless flexible metal or rubber-like pipes are used. Take special care to fill each part of the form by depositing the concrete as near to its final position as practicable. Work back the coarse aggregate from the face of the forms and force concrete around the reinforcement without displacing the bars. Do not jar the forms after the initial set of the concrete. Do not place any strain on the ends of lap reinforcement projecting from the forms.
16. Consolidate concrete by continuously working with a suitable tool or by the use of an internal vibrator in accordance with **Subsection 702.4.2.4**. If vibration cannot be done effectively because of obstruction by reinforcement or other causes, consolidate concrete by vibrating the form in a manner satisfactory to the RCE.
17. Except in the fabrication of prestressed concrete members, place concrete in horizontal layers not more than 18 inches thick, unless hereinafter specified. When less than a complete layer of concrete is placed in one operation, terminate it in a vertical plane. To prevent injury to the green concrete and to avoid surfaces of separation between the batches, place and compact each batch in a layer before the preceding batch has taken initial set.
18. When the placing of concrete is temporarily discontinued, wait until concrete has become firm enough to retain its form, and then, clean the concrete of laitance and other objectionable material to a sufficient depth to expose sound concrete. To avoid as many visible joints as possible, smooth the surface of the concrete adjacent to the forms with a trowel.

702.4.2.2 Construction Joints

1. Do not provide construction joints except for those shown on the Plans or those approved by the BCE. Provide approved bulkheads and keys as specified below.
2. When joining fresh concrete to concrete that has already set, thoroughly clean the surface of the concrete in-place and adjacent forms and remove all chalky, loose, or foreign materials. Clean reinforcing steel so that it is free from loose or thick rust, dirt, scale, dust, paint, oil, concrete mortar, curing compound, or other foreign material. In inaccessible places, such as small columns and thin walls, clean the surface as stated above before setting the forms. Immediately before placing the new concrete, draw the forms tight against the concrete already in-place; thoroughly wet the old concrete surface and coat with a thin coating of mortar, neat cement, or other suitable bonding material.
3. When shown on the Plans, make the construction joint resistant to shear by placing raised or depressed keys on the surface of the concrete first poured. In general, make the width of the key about 1/3 of the total width of the section and make the key occupy about the middle third of the section. Make the height/depth of the key about 1/3 of its width. Steel dowels may be used instead of keys only upon the written approval of the BCE.

702.4.2.3 Pumping Concrete

1. Make certain that vibrations from pumping equipment do not damage freshly placed concrete. Provide a suitable type of pumping equipment with adequate capacity for the work. Ensure that the pump provides a continuous stream of concrete without air pockets.

702.4.2.4 Vibration of Concrete

1. When required, use vibrators in conformance with the requirements of **Subsection 702.3.1**.
2. Vibrate all classes of concrete except Class 4000DS and Class 4000S. Use vibrators during placement of non-prestressed concrete as specified in this subsection. For prestressed concrete, use vibrators as specified in **Subsection 704.4.4.1** in addition to the requirements of this subsection.
3. Apply vibration at the point of deposit and in the area of freshly deposited concrete. Slowly insert and withdraw the vibrators from the concrete. Ensure that the vibration is of sufficient duration and intensity to thoroughly compact the concrete, but do not continue to the point of causing segregation. Do not continue vibration at any one point to the extent that localized areas of grout are formed.
4. Apply vibrators at uniformly spaced points, but not farther apart than twice the radius that the vibrator is visibly effective.
5. Supplement vibration by spading as is necessary to ensure smooth surfaces and dense concrete along form surfaces and in corners and locations impossible to reach with the vibrators.
6. Perform vibration in a manner that avoids contact with forms and ties as much as is practicable. Do not use vibrators to move the concrete.

702.4.2.5 Mass Concrete Placement

1. Use procedures for mass concrete placement for a pour that has dimensions of 5 feet or greater in 3 different directions. In the case of a circular cross-section, a mass concrete placement is defined as a pour that has a diameter of 6 feet or greater and a length of 5 feet or greater. Mass concrete requirements do not apply to Drilled Shafts (Class 4000DS) and Foundation Seals (Class 4000S).
2. For all mass concrete pours, do not allow the mix temperature to exceed 80°F measured at discharge into the forms. Maintain a temperature differential of 35°F or less between the interior and exterior of all mass pour elements during curing.
3. Before placing mass concrete, submit to the BCE for review and acceptance a *Mass Concrete Placement Plan* containing, but not limited to, the following:
 - Analysis of the anticipated thermal developments within mass pour placements using the proposed materials and casting methods,
 - *Temperature Control Plan* outlining specific measures to control the temperature differential within the limits noted above, and
 - Details of the proposed monitoring system.
4. Submit for review by the OMR all special concrete mix designs, which are part of the *Temperature Control Plan*.

5. Provide temperature monitoring devices to record temperature development between the interior and exterior of the element at points accepted by the BCE and closely monitor the mass pour temperature differential. Generally, use one monitoring point in the center of the largest mass of concrete and a second point approximately 2 inches inside the face nearest to the first monitoring point. Continue monitoring temperature until the interior temperature is within 35°F of the lowest ambient temperature or a maximum of two weeks. Provide the RCE with a copy of each set of readings as they are taken and a temperature chart for each mass pour element showing temperature readings vs. time.
6. If the monitoring indicates that the proposed measures are not controlling the concrete temperature differential within the 35°F specified, make the necessary revisions to the *Temperature Control Plan* and submit the revised plan for review.
7. The Contractor assumes all risks connected with placing a mass pour of concrete. RCE review of the Contractor's *Mass Concrete Placement Plan* will in no way relieve the Contractor of the responsibility for obtaining satisfactory results. Should any mass concrete placed under this specification prove unsatisfactory, make the necessary repairs or remove and replace the material at no expense to the Department.
8. Provide the control of temperatures in mass concrete pours in addition to any other requirements found on the Plans and/or in the Special Provisions that apply to the work in question. Include all costs associated with temperature controls for mass concrete placement in the unit cost of the concrete.

702.4.2.6 Depositing Concrete Underwater

1. When concrete is permitted to be deposited in water by the Plans, the Special Provisions, or with the written approval of the BCE, ensure that the concrete and procedure conform to the following requirements:
 - a. Conform to the requirements of **Subsection 712.4.13** for depositing Class 4000DS concrete in water.
 - b. Make certain that Class 4000S concrete has a slump of approximately 8 inches.
 - c. When considered desirable, use a water-reducing retarder to delay the initial set of the concrete deposited under water in the proportion accepted by the OMR.
 - d. To prevent segregation, carefully place the concrete in a compact mass in its final position by means of a tremie, or other method accepted by the BCE, and do not disturb the concrete after being deposited.
 - e. Maintain still water at the point of deposit.
2. Unless otherwise permitted, place concrete seals continuously from start to finish and keep the surface of the concrete as nearly horizontal as is practicable at all times. Ensure thorough bonding by placing each succeeding layer of a seal before the preceding layer has taken its initial set. Remove all laitance and foreign matter from the top surfaces before any concrete is placed upon it in the dry.
3. If a tremie is used to place the concrete, support the tremie to permit free movement of the discharge end over the entire top surface of the work and to allow rapid lowering when necessary to retard or stop the flow of concrete. At the start of work, close the discharge end with an approved plug or mechanical means to entirely seal the tremie tube and prevent the entry of water. Keep the tremie tube full to the bottom of the hopper. When a batch is dumped into the hopper, induce the flow of concrete by slightly raising the discharge end of the tremie while keeping it in the deposited concrete. Make certain that the flow is

continuous until the work is complete. Two or more complete tremies including hoppers may be required by the BCE for large footings and other locations where the additional tremies are considered desirable.

702.4.2.7 Concrete Exposed to Tidal Water

1. Make certain that concrete structures exposed to tidal water are constructed with maximum resistance to the disintegrating action of the water. Where reinforced concrete is used in tidal water, accurately place the reinforcement and rigidly hold it in place. Make certain that the clear distance from the face of the concrete to the nearest face of any reinforcement bar is not less than the clearance shown on the Plans.
2. Except for the initial surface finish, do not disturb the original formed surfaces below the elevation of high tide. In order to secure a thick and dense surface film, heavily coat the form surface with shellac or acceptable form oil.
3. In tidal water, do not locate construction joints in concrete between the elevations of extreme low tide and extreme high tide as indicated on the Plans. Bring to the attention of the BCE field conditions that are not addressed in the Plans that may affect the construction joint location or cause deterioration of concrete, such as wave action or other conditions. The BCE will implement changes if warranted.
4. Deposit concrete in-the-dry in tidal water within the range of tidal water indicated in paragraph 3 above. Do not allow tidal water to come in direct contact with the concrete until the concrete has hardened for at least 3 days.

702.4.2.8 Temperature Control

702.4.2.8.1 Concreting in Cold Weather

1. Before starting work on the project, submit a written *Placing and Curing Plan* that includes measures and equipment to ensure that the air temperature surrounding the concrete is maintained at a temperature above 50°F as monitored by Hi-Lo thermometers placed on the concrete surface for a period of 3 days after the concrete is placed. If curing blankets are used, make certain that they conform to the requirements found in **Subsection 702.3.4**, and remain in place for a minimum of 4 days. Provide provisions in the plan for sudden temperature changes below those forecasted during the curing period. If dry heat is used, provide a means of maintaining moisture in order to maintain the concrete in a wet condition during the curing period.
2. Do not place concrete unless specifically authorized by the RCE, who may only issue such authorization upon receipt and acceptance of a written *Cold Weather Batching and Mixing Plan* as specified in **Subsection 701.4.4.2**.

702.4.2.8.2 Concreting in Hot Weather

1. Before starting work on the project, submit a written *Placing and Curing Plan* that includes measures and equipment to maintain the temperature of concrete below 90°F, with the exceptions of Class 2500 concrete and mass concrete pours. Ensure that the plan conforms to the applicable requirements of ACI 305R, *Hot Weather Concreting*. The plan may incorporate one or more of the following provisions as necessary to control the concrete temperature:
 - a. Schedule work so that concrete can be placed with the least possible delay.
 - b. Sprinkle coarse aggregate with water to cool by evaporation.

- c. Use chilled mixing water or shaved ice to replace part of the mixing water, and consider the use of Type II cement.
 - d. Reduce loss of water through absorption by pre-wetting the subgrade or forms just before pouring so that they will not absorb water from mix.
 - e. Spray forms and reinforcing steel with cool fresh water just before placement of concrete.
 - f. Erect windbreakers to prevent wind from drying exposed concrete surfaces while they are being finished.
 - g. Screed and float concrete as it is placed, and start curing procedures immediately.
 - h. Use water-curing methods to provide evaporative cooling.
2. Do not allow the temperature for Class 2500 concrete to exceed 95°F. Do not allow mass concrete mix temperature measured at discharge into the forms to exceed 80°F.
 3. Do not place concrete unless specifically authorized by the RCE, who may only issue such authorization upon receipt and acceptance of a written *Hot Weather Batching and Mixing Plan* as specified in **Subsection 701.4.4.2**.

702.4.2.8.3 Responsibility for Satisfactory Results of Temperature Control

1. The Contractor assumes all risks connected with the placing of concrete, and any permission given to place concrete under such conditions will in no way relieve the responsibility for satisfactory results. Remove, dispose of, and replace all unsatisfactory concrete at no expense to the Department.
2. Provide the control of temperatures in concrete placement in addition to any other requirements found on the Plans and/or in the Special Provisions that may apply to the concrete placement. Include all costs associated with temperature controls for concrete placement in the unit cost of the concrete.

702.4.3 Setting Finished Grade of Concrete Bridge Deck Slabs

702.4.3.1 Setting Finished Grade When Covered with a Wearing Surface

1. After concrete is placed in deck slab forms, strike-off the top to the proper crown and longitudinal profile with an approved template. Do not deviate from the surface indicated on the Plans by more than ½ inch.

702.4.3.2 Setting Finished Grade When Not Covered with a Wearing Surface

1. As soon as the concrete has been placed and vibrated in the deck slab forms in a section of sufficient width to permit working, strike-off the concrete with sufficient passes of the screed to obtain the required grade (usually 1 or 2 passes for the transverse screed and 2 or 3 passes for the longitudinal screed are sufficient).
2. Maintain a slight excess of mortar along the entire leading edge of the screed at all times to fill low spots. On the final pass of the screed, leave the surface true to grade and free from water, laitance, or other conditions leading to an undesirable surface. Take care to remove all such surplus material from the gutters where final hand finishing is permitted. Complete all screeding before the initial set of the concrete has taken place.
3. As screeding is completed at the beginning or end of a pour, especially where fresh concrete adjoins hardened concrete, carefully check the surface of the slab in the longitudinal direction with a 20-foot straightedge, or if approved by RCE, use a 10-foot straightedge due to the vertical curve ordinate. Correct all abrupt changes that would affect the surface smoothness

while the concrete is still plastic. Closely following the final pass of the screed, texture the surface by using a drag composed of 2 layers of wet burlap on a transverse screed or an RCE approved broom on longitudinal screeds.

4. Finish the surface of the deck under sidewalks or barriers to the proper grades shown on the Plans and finish the surface to the same surface texture as the wearing surface. Along the edges of the slab where the screed cannot pass, make certain that concrete finishers use a straightedge, minimum 4 feet in length, and ensure that the proper slope of the deck is maintained.
5. In the case of concrete slab spans or concrete girder spans supported on falsework, finish the top surface of the slab with a camber sufficient to offset the dead load deflection of the slab and the long-term creep of the concrete while still maintaining the proper vertical curve ordinate. Unless otherwise directed by the BCE, use a camber of $\frac{1}{8}$ inch for spans 20 to 30 feet long. Place camber strips on the falsework support beams, bar joist, etc., which include the effect of dead load deflection and any applicable vertical curve ordinate to maintain the proper thickness of the deck.
6. For spans of 80 feet and under, the Contractor may use a longitudinal screed equal to the length of the span. For spans greater than 80 feet, but equal to or less than 100 feet, if possible, use a screed equal to the span length, but in any case, do not use a major longitudinal screed less than $\frac{1}{2}$ of the span length.
7. Include all costs for labor, equipment, and other items necessary to provide the finished grade of concrete deck described above in the unit price of the concrete.
8. Have the slab checked by the RCE at representative locations using suitable means to determine deviations from the theoretical plan grade. Do not allow the maximum deviation from the theoretical plan grade to exceed $\frac{1}{1200}$ of the bridge length or $\frac{1}{2}$ inch, whichever is smaller. Do not allow the maximum deviation from the theoretical crown in a direction normal to the traffic direction to exceed $\frac{1}{4}$ inch. Remove excessive height of ridges formed by the finishing processes. If the Plans indicate that the future design traffic count is less than 1000 vehicles per day, with the RCE present, check the slab for smoothness by means of a rolling straightedge immediately after the curing operation is complete. Provide the rolling straightedge equipped with devices for marking irregularities in the slab surface of $\frac{1}{8}$ inch or more in a length of 10 feet. For temporary detour bridges, $\frac{1}{4}$ inch or more in a length of 10 feet is acceptable. Details of an acceptable rolling straightedge are available from the BCE office and will be furnished on request.
9. In addition to the longitudinal rolling straightedge check, make certain that the deck surface meets a 0.20 inch in 10 feet straightedge check made transversely across the slab at a spacing determined by the RCE. Perform the longitudinal rolling straightedge tests first.
10. Remove or correct irregularities that exceed the maximum deviations stated in this subsection in a manner satisfactory to the RCE and/or BCE at no expense to the Department. Do not perform grooving before satisfying the requirements of this subsection.

702.4.4 Concrete Curing

702.4.4.1 Curing of Bridge Decks

1. Exercise caution to prevent plastic cracking from occurring in bridge decks. Follow the latest ACI 224R and ACI 305R guidelines on control of cracking and hot weather concreting.
2. Protect freshly placed structural concrete from rapid drying. Use high efficiency multiple-head water foggers with individual shut-off valves or an alternative acceptable to the BCE to increase the humidity directly above the fresh concrete until the curing mats are placed. Demonstrate the fogger system for the RCE and make certain that it is accepted before placing concrete. Do not allow the foggers to spray directly onto the concrete. However, condensation from the foggers that wet the concrete without causing surface damage is acceptable. Provide a minimum of two foggers with a third back-up fogger on hand in case of a breakdown. Provide additional foggers as required for wide and/or large deck pours. The use of a pressure washer with a fine mist nozzle on the wand in lieu of using foggers is acceptable provided there is a satisfactory performance in the field as determined by the RCE. Make certain that the system does not drip or pond water on the concrete. Ensure that the system sprays over the concrete (a minimum of 4 feet) and not directly on the concrete and maintains the humidity over the entire surface of the concrete until the curing mats are installed. Be aware that these measures alone may not prevent plastic cracking of the deck. Provide other preventative measures as necessary including windbreaks, placement of approved curing compound, or if necessary, delaying the pour until more suitable conditions.
3. Wet-cure the top surface of the bridge decks for a minimum of 7 days.
4. Construction traffic may be placed over the slab if 90% of the 28-day compressive design strength has been reached even though curing blankets are still in place. Obtain approval from the RCE to place construction traffic on the slab in less than 7 days. Base strength on breaks of cylinders that have been cured similarly to the deck.
5. Provide and maintain a curing box at the testing site to cure cylinders for 28-day breaks. Make certain that the curing box is capable of holding cylinders at a temperature between 60°F and 80°F until cylinders are shipped to the OMR for storage in a curing room before conducting compression breaks. Provide a Hi-Lo thermometer to monitor the temperature range. Modify the curing box as necessary if the required temperature range is not being maintained.
6. Perform curing by use of curing blankets conforming to the requirements of **Subsection 702.3.4**. Place curing blankets as soon as practicable after placing the concrete. Overlap edges of blankets. Re-wetting of the curing blankets may not be required if the blankets remain wet and the edges remain sealed throughout the 7-day curing period.

702.4.4.2 Curing Structural Concrete Other than Bridge Decks

1. Wet-cure structural concrete other than bridge decks for a period of 4 days and cover with curing blankets described in **Subsection 702.4.4.1**. Re-wetting of the curing blankets and overlapping edges may not be required if the blankets remain wet and the edges remain sealed throughout the curing period. Cure precast and prestressed concrete members in accordance with the requirements of **Subsection 704.4.4.3**.
2. Polyethylene sheeting may be used for curing concrete columns. Take extreme care and make certain that the overlapping edges of the adjacent wraps and the extreme edges of the sheeting are sealed and a saturated condition is maintained at all times inside the enclosure.

3. If a final finish coating is specified by the manufacturer as being capable of acting as a curing membrane, apply the coating immediately on any portions of the structure that require a finish coating. Apply material at the rate as specified in **Subsection 702.4.11**.
4. A clear, non-wax, water-based, dissipating membrane-curing compound may be used as soon as practical instead of curing blankets. Ensure that it meets the requirements of **Subsection 702.2.2.11**.
5. Apply the curing compound as soon as the finishing of the concrete surface is complete. Apply the compound uniformly at a rate of at least 1 gallon per 150 square feet until the entire surface has a solid and vapor-tight coating of the curing compound. Apply the compound by means of a spray nozzle that is held 2 feet or less from the concrete surface. If necessary, protect the spray from the wind by suitable means. Keep the spray nozzle and other spraying equipment clean at all times.
6. If rain falls on the newly sprayed surface before the film has sufficiently dried, immediately as conditions permit, re-spray the surface to the specified thickness. Where the curing compound is inadvertently applied to surfaces against which new concrete is to be cast, including projecting reinforcing steel, completely remove the compound by the use of steel wire brushes or by other means accepted by the RCE.
7. Protect the sprayed surface film from abrasion or damage for at least 3 days. Do not allow the placing of forms, lumber, reinforcing steel, equipment, or unnecessary walking on the surface until the film is at least 3 days old.

702.4.5 Removal of Falsework and Forms

1. In order to obtain a satisfactory surface finish, remove the forms for ornamental work, railings, parapets, and other vertical surfaces that will be exposed in the finished work as soon as the concrete has hardened sufficiently to allow the removal of the forms without damaging the edges, corners, and faces of the concrete. Do not remove the forms in less than 5 hours, nor more than 48 hours, unless the concrete is poured on Friday, in which case the forms may be removed the following Monday. Column and pier forms may be removed after 24 hours.
2. Keep forms and falsework under slabs, beams, girders, caps, arches, and structures or parts of structures carrying static dead loads in place until the concrete compressive strength reaches at least 75% of the design strength. Make additional test cylinders and cure under similar conditions for use in form removal strength determinations.
3. Do not use methods of form and falsework removal that are likely to cause overstressing of the concrete. In general, remove the forms from the bottom upward. Do not remove forms without the consent of the RCE.
4. Strike falsework supporting concrete beams, slabs, and brackets that will support sidewalks, concrete railing, or other applicable items before the sidewalk, concrete railing, or the other items are cast.
5. Make additional strength control cylinders if early removal of falsework is desired. The falsework may be struck when these cylinders, cured under the same conditions as the concrete in the structure, have developed a unit strength of 75% of the required 28-day compressive design strength. However, do not subject such concrete to a superimposed load until the compressive strength develops 90% of the required compressive design strength. Assist in transporting the additional strength control cylinders to the OMR for testing.

6. Extra test cylinders for early form or falsework removal will be at no additional expense to the Department.

702.4.6 Protecting and Loading Recently Placed Concrete

1. Do not place beams, girders, or other precast elements on concrete substructures until the concrete in the substructure develops a minimum of 75% of the design compressive strength. Do not place deck concrete until the concrete in the substructure develops a minimum of 90% of the design compressive strength.
2. Do not place backfill or fill for retaining walls, abutments, piers, wingwalls, or other structures that will retain material to an elevation higher on one side than on the other until the concrete develops a minimum of 90% of the specified design strength.
3. Do not place backfill for arch culverts and box culverts to an elevation higher than 1 foot above the top of footing or bottom slab until the concrete develops a minimum of 90% of specified design strength.
4. Adhere to the following time and strength requirements when performing construction activities on or near recently placed concrete:
 - Wait a minimum of 12 hours between placing footing or drilled pier concrete and erecting column forms.
 - Wait a minimum of 24 hours between placing footing and drilled pier concrete and placing column concrete.
 - Wait a minimum of 72 hours between placing column concrete and beginning erection of cap forms or until column concrete attains a minimum of 75% of the design compressive strength as verified by testing extra test cylinders.
 - Wait a minimum of 96 hours between placing column concrete and placing cap concrete or until column concrete attains a minimum of 75% of the design compressive strength as verified by testing extra test cylinders.
 - Wait a minimum of 12 hours after a drilled shaft or drilled pile concrete has achieved the initial set, determined by the RCE or BCE, before installing adjacent piling or drilling adjacent shaft/drilled pile within a 20-foot radius of the cast concrete item. Multiple shafts or piles may be drilled before placing concrete if the drilled holes remain in a stable condition. For non-cased drilled shafts or drilled piles, wait until the cast concrete attains a minimum of 75% of the design compressive strength, verified by testing test cylinders, before placement of a construction vehicles or equipment are allowed within the 20-foot radius of the cast concrete item.
5. Do not blast within a 50-foot radius of any cast structural concrete item until the cast item attains 90% of the design compressive strength verified by testing concrete test cylinders.
6. The requirements of this subsection are minimum requirements. Additional restrictions or increased wait times may be required to protect the concrete if deemed necessary by the RCE or BCE. Suspend any activity determined by the RCE or BCE to be detrimental to the concrete item cast regardless of the distance from the cast concrete until such time as the RCE or BCE allows the activity to proceed or until the cast concrete attains a minimum of 90% of the design compressive strength verified by testing concrete test cylinders.

7. Do not place highway traffic, construction vehicles, and/or construction loads/equipment on a bridge deck or approach slab until the concrete develops a minimum of 90% of the specified design compressive strength verified by testing concrete test cylinders.
8. Do not abruptly start or stop construction vehicles, construction equipment, concrete trucks, etc. on bridge deck(s) and/or approach slabs. Do not mix concrete in a truck mixer while the truck is on the deck without permission from the RCE. To avoid excessive vibrations while placing concrete barrier rail or parapet, do not place any equipment on the deck except for one concrete truck mixer if required. Do not place other equipment or traffic on the deck until concrete barrier rails and parapet walls obtain a minimum of 75% of the compressive design strength verified by testing test cylinders.
9. Make test cylinders for early testing to determine the concrete compressive strength for all items of the structure that are required to meet 75% of the design compressive strength.
10. Make early break test cylinders to determine concrete strength if early live loading, including highway traffic and/or construction equipment loading is desired. Assist the RCE in the making and transporting of early break test cylinders to the OMR.
11. If loads or equipment exceeding 80,000 pounds gross weight are intended to be placed on the structure, submit 7 copies of the proposed plan with calculations for placing the load(s) on the structure for review, comments, and written acceptance by the BCE. Have the plan and design calculations prepared by a South Carolina registered Professional Engineer.

702.4.7 Initial Surface Finish

1. Thoroughly vibrate and work the concrete in all structures during the placement operation by means of suitable tools. Ensure that the vibrating and working forces the coarse aggregate from the surface and thoroughly works the mortar against the forms to produce a smooth finish free from water-pockets, air pockets, sand streaks, and honeycombing.
2. As soon as the concrete has met the strength requirements specified in **Subsection 702.4.5**, carefully remove the forms. Immediately following form removal, perform the initial surface finishing as described herein.
3. Remove fins and ridges in the concrete surface resulting from misaligned forms by grinding or other methods accepted by the RCE.
4. Use sand and cement mortar to carefully point all depressions resulting from the removal of metal ties and other holes and rough places. Make sure pointed surfaces are flush with the surrounding structure surface by means of a wooden float (or equivalent) before setting of the sand and cement mortar mixture occurs.
5. The RCE may assess a 10% price reduction to the unit bid price of concrete that does not have the initial surface finish described above completed within 7 calendar days of form removal. Provide this initial surface finish to all surfaces to receive the final finish in accordance with **Subsection 702.4.11**.

702.4.8 Repair of Concrete Surface Defects

1. After initial finishing is complete, the RCE will inspect the concrete surfaces. Repair minor surface defects as specified herein. When it is necessary to add a thin layer of structural grout/concrete to old concrete, use a suitable type of epoxy bonding compound that produces an adequate bond between the two layers. Make certain that the grout/concrete is suitable for the type of concrete repair for which it will be used, and that the epoxy

compound meets the requirements of ASTM C 881. Obtain acceptance by the OMR or BCE of grout/concrete and epoxy before its use.

2. Make certain that repair areas have near-vertical edges and do not result in feathered-edged patches.
3. The repair described above does not apply to the top surface of bridge decks. Repair defective areas of concrete on the top surface of bridge decks in accordance with the requirements of **Subsection 702.4.10**.

702.4.9 Repair of Crack in Top Surface of Bridge Decks

1. Fill bridge deck cracks or portions of cracks, including construction joints, with widths of 0.007 inch or greater, which appear before the bridge is opened to the traveling public, at no expense to the Department. Fill the cracks using a gravity flow, low viscosity, crack healer/penetrating material capable of filling cracks down to 0.003 inch. Use crack sealing material meeting the requirements of ASTM C 881. Obtain acceptance of the crack sealing material from the RCE before its use. Maintain a small pond of epoxy over the crack long enough to allow the gravity flow to fill the crack. Once the flow has stopped, remove excess material from the deck surface before the epoxy hardens. If the cracks cannot be filled with the gravity flow material, use a pressure injectable product acceptable to the BCE. Fill cracks before any contamination of the cracks occurs. If the RCE suspects that cracks are not being adequately filled, take cores as directed by the BCE to verify the extent to which the cracks are being filled.
2. Make repairs at no additional cost to the Department, and such repairs will not justify extension of the contract completion date.

702.4.10 Repair of Top Surface of Bridge Decks

702.4.10.1 Repair of Small Areas in Top Surface of Bridge Decks

1. Repair isolated small holes (approximately 1 inch or less in diameter) with near vertical sides with an epoxy patching material with sand added.
2. For small defective areas (equal or less than 4 square feet total) on the top surface of bridge decks, use the following repair procedure:
 - 1) Outline the defective areas and sawcut the outline to a minimum depth of 1½ inches.
 - 2) Remove all defective and/or delaminated concrete in the outlined areas by use of a concrete milling machine to a minimum patch depth of 1½ inches. A mechanical scarifier may be used on small areas. If jackhammers are used, limit the maximum size to 15 pounds. Do not damage the vertical sides of the sawcut during concrete removal.
 - 3) Remove all grease, dirt, oil, or foreign material from the patch areas by blast cleaning.
 - 4) Immediately before placing patching material, remove all dust, sand, and blasting debris with oil-free compressed air.
 - 5) Design a repair concrete mix with 35% Aggregate No. 89M stone by volume. Submit the proposed concrete mix design to the OMR for review and furnish a copy to the RCE. Do not use the mix until it has been accepted by the OMR.

- 6) Immediately after cleaning, while the vertical edge surface is dry and the air temperature and concrete surface temperature are between 50°F and 80°F, apply an approved moisture resilient epoxy bonding compound meeting the requirements of ASTM C 881 in accordance with the manufacturer's recommendations to all vertical edges of the repair area.
 - 7) While the epoxy is tacky, pour in the accepted concrete repair mix.
 - 8) Finish off the top on the new patch to the proper grade and cure the patch in accordance with **Subsection 702.4.4.1**, unless otherwise directed by the BCE.
3. Complete repair work before grooving the bridge deck.
 4. Make repairs at no additional cost to the Department. Repairs will not justify extension of the contract completion date.

702.4.10.2 Repair of Large Areas on the Top Surface of Bridge Decks

1. For large defective areas (greater than 4 and less than 500 square feet total) on the top surface of bridge decks, repair using the following procedure:
 - 1) Outline the defective areas and sawcut the outline to a minimum depth of 1½ inches.
 - 2) Remove all defective and/or delaminated concrete in the outlined areas by use of a concrete milling machine and/or jackhammers to a minimum depth of 1 inch below the top mat of reinforcing steel. A mechanical scarifier may be used on small areas. If jackhammers are used, limited the maximum size to 15 pounds. Do not damage the reinforcing steel or the vertical sawcut sides during concrete removal.
 - 3) Remove all grease, dirt, oil, or foreign material from the patch areas by blast cleaning.
 - 4) Immediately before placing patching material, remove all dust, sand, and blasting debris with oil-free compressed air.
 - 5) Design a repair concrete mix with 35% Aggregate No. 89M stone by volume. Submit the proposed concrete mix design to the OMR for review and furnish a copy to the RCE. Do not use the mix until it has been accepted by the OMR.
 - 6) Immediately after cleaning, while the vertical edge surface is dry, and the air temperature and concrete surface temperature are between 50°F and 80°F, apply an approved moisture resilient epoxy bonding compound meeting the requirements of ASTM C 881 or AASHTO M 235 in accordance with the manufacturer's recommendations to all vertical edges of the repair area.
 - 7) While the epoxy is tacky, pour in the accepted concrete repair mix.
 - 8) Finish off the top on the new concrete patch to the proper grade and cure the patch in accordance with **Subsection 702.4.4.1**, unless otherwise directed by the BCE.
2. Complete all repair work before grooving the bridge deck.

3. For the repair of extremely large defective areas on top surface of bridge decks (equal to or greater than 500 square feet total), place a low slump or latex overlay to restore the deck to an acceptable condition. Make certain the overlay conforms to the requirements of **Section 726**.
4. Make repairs at no additional cost to the Department. Repairs will not justify extension of the contract completion date.

702.4.11 Final Finish of Exposed Concrete Surfaces other the Bridge Decks

702.4.11.1 General

1. Provide a final finish of exposed concrete surfaces of structures, except for bridge deck slabs, as specified in the Plans and in accordance with the following requirements for a sprayed or brushed finish. Unless otherwise specified, the finish used is at the option of the Contractor. However, use the same finish, either sprayed or the brushed, throughout the structure. Notify the RCE of the type surface finish intended for use before the start of the finishing work. Obtain verification from the finishing material manufacturer that the curing membrane material is compatible with the specified finishing material.
2. Use final finish coating material from sources appearing on the most recent edition of *SCDOT Qualified Product List 7*.
3. Furnish the following information with each shipment of finish coating material:
 - Material certification showing brand name,
 - Production batch or lot numbers,
 - Manufacturer's recommended rate of application,
 - Materials Safety Data Sheet,
 - Materials Data Sheet,
 - SC File No.,
 - Shipping date, and
 - To whom it is shipped.
4. Make certain that the certificate states that the material meets SCDOT specifications and is essentially the same as that appearing on the most recent edition of *SCDOT Qualified Product List 7*. Ensure that the shipped containers are plainly marked with the manufacturer's name and trademark, the production lot or batch number, a clear date indicating date of manufacture and/or shelf life expiration date, and application procedures. Submit for evaluation by the OMR all formulation changes after initial approval.
5. Apply finish coating material at the manufacturer's recommended rate of application.

702.4.11.2 Surface Preparation for Finish Coat

1. Remove all foreign matter such as dirt, dust, mildew, efflorescence, and curing compound on the surface by water blasting. Ensure that water used for cleaning is either a potable water or a clean supply approved by the RCE. Make certain that the water leaves no residue that would impair bonding. Provide water blasting equipment that has a minimum working pressure of 3000 psi with a 15-degree tip, an output of approximately 4.5 gallons per minute, a 10 HP or equivalent pump, and is equipped with a working pressure gauge near the nozzle to check the working pressure.

2. In the event the foreign matter is not removed by the water blast method, use an alternate cleaning method, such as sandblasting or high-pressure water blasting equipment, to clean the surface.
3. When a clear curing compound has been used, allow enough time (usually 20 to 45 days) for the membrane to dissipate, and then clean completely to remove any membrane that remains.

702.4.11.3 Application of Final Finish Coating

1. Allow the concrete to cure for 28 days before application of final finishing coat. A shorter cure time may be allowed by the RCE if it is recommended by the manufacturer of the material. After the surface is cleaned, apply the coating before contamination occurs. If adverse weather or other obstacles prevent a timely coating application, re-clean the surface as determined by the RCE. Make certain that the surface is clean and surface dry in accordance with the manufacturer's recommendations before application of the coating. If the coating is sprayed, use application equipment recommended by the manufacturer of the coating. Make certain the spray procedure is as approved by the coating manufacturer. Ensure that the coverage per gallon of the coating is in accordance with these specifications and does not exceed 60 square feet per gallon.

702.4.11.4 Sprayed Final Finish

1. Use a material for the high-build spray finish coat that is a factory mixed coating applied as a single spray coat at the rate of 55(± 5) square feet per gallon of coating. Ensure that the finish coat is uniform in color, coverage, and texture. The uniform coverage may vary in dry mil thickness depending on the properties of the product being used, but minimize variation by strict control of the application rate. Apply the spray coat uniformly to dry and clean surfaces that have received the initial surface finish. Allow the concrete to cure 28 days before application of the final finish coating. A shorter cure time may be allowed by the RCE if it is recommended by the manufacturer of the material. Apply the sprayed finish strictly in accordance with the written instruction of the product manufacturer. Ensure that the actual application of the material is done by an operator specially trained for this work and is skilled in the application of the sprayed finish.
2. Ensure that the spray material is for exterior coating. Use the color Near White (Federal Shade No. 37778) with smooth texture. The spray coating material may be solventborne or waterborne. Make certain that it meets the following requirements:
 - a. Durability by accelerated weathering testing is 5000 hours minimum in accordance with ASTM G 153.
 - b. Durability by freeze thaw testing is 50 cycles minimum without detrimental effect. Conduct the test procedure by means of a test chamber capable of maintaining a -15°F temperature for 1 hour and a +70°F temperature for 1 hour, which constitutes one freeze thaw cycle.
 - c. Durability by salt spray testing is 300 hours minimum in accordance with ASTM B 117 without loss of adhesion or deterioration of the coating.
 - d. Moisture vapor permeability is 0.4 metric perms minimum in accordance with ASTM E 96.

3. Make certain that the solventborne coating complies with the following requirements:
 - a. The resin is a vinyl toluene acrylic copolymer resin having a sward hardness of 48 minimum when tested at 33.3% solids.
 - b. The solvent is mineral spirits (aliphatic).
 - c. The pigment is 55% minimum by weight.
 - d. The non-volatile vehicle (% by weight of vehicle) is 35% minimum.
 - e. VOC is 3.5 pounds/gallon maximum.
 - f. The coating total solids is a minimum 68% by weight.
4. Ensure that waterborne coating complies with the following requirements:
 - a. The resin is 100% pure acrylic copolymer emulsion. Monomers are Butyl acrylate or methyl methacrylate. Vinyl acetates and styrene-modified copolymers are not allowed.
 - b. The solvent is water.
 - c. The pigment is 55% minimum by weight.
 - d. The non-volatile vehicle (% by weight of vehicle) is 20% minimum.
 - e. The coating total solids is a minimum 62% by weight.
 - f. The pH is 9.0 to 10.5.

702.4.11.5 Brushed Final Finish

1. At the Contractor's option, a brushed finish material may be applied to all exposed surfaces throughout the structure instead of a sprayed finish material. If selected, apply the brushed final finish material in 2 separate coats to provide a uniform finish of good texture on exposed surfaces that have received the initial surface finish. Mix the material and apply strictly in accordance with the written recommendations of the product manufacturer. Have the material applied by workers who have been instructed in the preparation and application of the material. Ensure that the final brushing of the material is generally done in one direction and results in a uniform and attractive appearance.
2. Use material recommended for brush application. Ensure that the material is specially manufactured for waterproofing exterior concrete surfaces and for enhancing the appearance of concrete surfaces. Make certain the final color of the finish is Near White (Federal Shade No. 37778) with a smooth texture.
3. Use material from a source appearing on the most recent edition of *SCDOT Qualified Product List 7*. Furnish the manufacturer's certification with each shipment stating that it meets the Department's specifications for a brushed-on application.

702.4.12 Limits of Initial and Final Finishes

1. Apply initial surface finish to all concrete surfaces as soon as the formwork is removed.
2. On bridges, apply final finish to all exposed surfaces as noted on the Standard Note Sheet of the Plans or in the Special Provisions. Discontinue the final finish 6 inches below the final ground line or at the low-water line.

3. For culverts and minor structures, apply the final finish on all permanently exposed concrete surfaces and carry it 18 inches back from the edges of all surfaces to be covered with earth. Continue the final finish at least 24 inches inside the barrel of the culvert at each end.
4. No separate payment for the initial and final finishes for concrete structures is made. Include the costs of labor, materials, and equipment in the items of work that receive the finishes.

702.4.13 Treatment of Horizontal Surfaces Not Subject to Wear

1. For upper horizontal surfaces, such as the tops of handrails, curbs, caps, parapets, coping, and bridge seats, place an excess of concrete in the form and remove or strike-off excess with a wooden template after a suitable interval of time and force the coarse aggregate below the mortar surface. Do not use a mortar topping for these surfaces. Finish all bearing surfaces smooth and level, either with a suitable trowel or by means of a suitable dry rub with an abrasive after the concrete is at least 2 days old.

702.4.14 Bridge Deck Rideability

702.4.14.1 Rideability When Contractor Provides Stakes, Lines, and Grades

1. Provide stakes, lines, and grades in accordance with **Subsection 105.8.3**, and perform bridge deck smoothness tests using a longitudinal rolling 10-foot straightedge check and a 10-foot straightedge check transversely across the deck as specified in **Subsection 702.4.3.2**. When the Plans indicate that the design (future) traffic count is greater than 1000 vehicles per day, provide a surface smoothness in conformance with **SC-M-701**.
2. Payment for the above work is in accordance with **Subsection 105.8.3**.

702.4.14.2 Rideability When the Department Provides Partial Lines and Grades

1. The Department will furnish the lines and grades for projects as specified in **Subsection 105.8.1**, except for all lines and grades affecting the bridge superstructure. This exception includes screed, overhang, beam, and header lines and grades, as well as parapet, rail, sidewalk, curb, or median lines and grades. Make certain of the proper computation and setting of the above-mentioned lines and grades. The RCE will make random checks of the lines and grades set by the Contractor to determine if the work is in substantial conformance with the Plans. The bridge deck rideability requirements of **Subsection 702.4.14.1** apply to the bridge structure.

702.4.15 Grinding and Texturing Bridge Decks

1. After checking the bridge deck for maximum allowable deviations and ride-ability requirements, remove irregularities and excessive deviations by grinding and texturing the deck as necessary to meet the requirements specified.
2. Make certain that the equipment used for grinding and texturing does not cause damage to other bridge components and does not damage deck concrete that is to remain. Do not allow depth of grinding to exceed ½ inch nor encroach upon the required rebar cover by more than ½ inch.
3. Use machines with diamond blades to produce a uniform texture finish with a high skid number without an excessive noise level under traffic. Do not texture the deck surface within 12 inches of the gutter lines and within 2 inches of expansion or deflection joints. The Contractor may elect to produce a textured finish simultaneously with the grinding operation.

4. Remove debris and residue from the grinding and texturing operation by vacuum or other methods approved by the RCE. Make certain all residue is legally disposed of off the construction site or uniformly distributed in the roadway embankment as directed by the RCE. Ensure that the debris and residue does not remain on the bridge deck nor is washed into the bridge drainage system.

702.4.16 Grooved Surface Finish

1. Except for rehabilitated decks or decks with staged construction and after the concrete has been cured and all applicable rideability specifications have been satisfied, groove concrete deck slabs perpendicular to the centerline for non-skewed bridges or parallel to the expansion or contraction joint for skewed bridges. Cut the grooves into the hardened concrete using a mechanical sawing device that leaves grooves that are 0.125 inch wide and 0.125 inch deep. Provide grooves with a center-to-center spacing that vary randomly from 0.625 inch to 1.125 inches.
2. After the concrete has been cured and all applicable rideability specifications have been satisfied, groove rehabilitated decks or decks with staged construction longitudinally and parallel to the centerline.
3. Limit grooving on non-skewed bridge decks as follows:
 - a. Extend grooving to a point measured 12 inches perpendicular to the gutterline or 12 inches perpendicular to the edge of any raised median.
 - b. Extend grooving to a point measured 2 inches from and perpendicular to the edge of expansion or contraction joints.
 - c. Do not groove across expansion or contraction joints.
4. Limit grooving on skewed bridge decks grooved parallel to the expansion or contraction joint as follows:
 - a. Extend grooving to a point not further than 18 inches and not closer than 6 inches from and perpendicular to the gutterline or edge of raised median.
 - b. Extend grooving to a point not further than 8 inches and not closer than 2 inches from and perpendicular to the edge of expansion or contraction joints.
 - c. Do not groove across expansion or contraction joints.
5. Remove residue from the sawing operation from the deck by vacuum or other methods. Make certain all residue is legally disposed of off the construction site or uniformly distributed in the roadway embankment as directed by the RCE. Ensure that the residue does not remain on the deck nor is washed into the bridge drainage system.
6. Notify the RCE at least 3 calendar days before performing any deck grooving work. Provide a written groove pattern to the RCE for approval before the work begins. Do not perform grooving without the presence of the RCE or a Department representative on site to view the grooving operation.

702.4.17 Joints

702.4.17.1 General

1. Provide fixed and expansion joints in concrete structures only at the locations shown on the Plans or otherwise specified. Ensure that expansion joint material conforms to the requirements of **Subsection 702.2.2**. Set all steel armor plates, strip seal joint plates, steel finger joint plates, etc. at $\frac{1}{4}$ inch below the finish roadway elevation.

702.4.17.2 Open Joints

1. Construct open joints by the use of removable bulk-heading forms that are removable without injury to concrete.

702.4.17.3 Sliding Joints

702.4.17.3.1 Roofing Felt

1. When roofing felt is used, make certain that the supporting or first formed concrete surface is true, smooth, and parallel to the direction of movement. Take care in cutting, placing, and holding the roofing felt against this surface so that it is smooth, snug, and does not become displaced or damaged during concrete placement. Hold the roofing felt in place by the forms or by asphalt cement carried well beyond the area of contact, then cut back after the forms are stripped and all rubbing and finishing near the joint is completed. Ensure that the entire joint presents a neat, workmanlike appearance, with absolutely no contact between the concrete on each side of the joint, and the joint is free to move in the proper direction for the required distance.

702.4.17.3.2 Metal Plates

1. When metal plates are used as friction joints, anchor them in the correct position with full bearing, and all sliding surfaces are planed true and smooth. When placed in position, thoroughly coat all sliding surfaces with graphite or other RCE approved lubricant. Do not impede movement because of contact with surfaces other than bearing surface.

702.4.17.3.3 Mortised Joints

1. Construct mortised joints as shown on the Plans and generally consisting of a concrete or metal element sliding in a concrete or metal socket. Ensure that the construction permits freedom of movement in the two opposite directions and is watertight and rustproof to the greatest extent practicable.

702.4.17.4 Fixed Joints

1. Separate fixed joints between superstructure and substructure by a layer of $\frac{1}{4}$ -inch thick elastomeric bearing pads, unless otherwise shown on the Plans. Unless otherwise specified, furnish elastomeric bearing pads in conformance with the requirements of **Section 724**, including measurement and payment.

702.4.17.5 Expansion Joints

702.4.17.5.1 General

1. Ensure that expansion joint materials consist of pre-molded filler, elastomeric compression seals, or deck joint strip seals.

702.4.17.5.2 Compression Seal Joints

1. Fabricate filled compression joints from elastomeric compression seals or pre-molded filler, or both as indicated on the Plans or in the Special Provisions or as directed by the BCE, and conforming to the requirements of **Subsection 702.2.2**.
2. Cut the joint filler out of the least number of pieces practicable to completely fill the space shown on the Plans. Bond the various pieces in the joint together as recommended by the manufacturer and approved by the OMR. Do not permit loose fitting sections or gaps between sections of filler or between filler and concrete or steel headers. Hold the material in place by asphalt cement or adhesive recommended by the manufacturer or by other suitable and RCE approved means.

702.4.17.5.3 Hot-Poured Elastic Filler Joints

1. Sawcut or form joints in concrete in accordance with **Subsection 501.4.13**. Fill formed joint with hot applied elastic filler material as specified in ASTM D 6690, Type III.
2. To avoid damaging hot poured elastic filler material by excessive heating, melt the filler material in a double-walled, oil-bath kettle. Cut the material into appropriate sized pieces with a hot spade and lower slowly into the kettle. Stir continuously to prevent local overheating. Keep the kettle filled to approximately half of its capacity at all times by adding new pieces as material is withdrawn. Provide an accurate pyrometer and heat the material in accordance with the manufacturer's instructions. Take care not to overheat the material. Watch for and avoid excessive smoke, which is one indication of local overheating.
3. Fill joint to within $\frac{3}{8}$ inch of the top surface of the slab. After joints are filled, the left over material in the kettle may be re-cut into suitable size pieces and re-heated later.

702.4.17.5.4 Deck Joint Strip Seals

1. Furnish and install deck joint strip seals in conformance to the requirements of **Section 723**.

702.4.17.6 Special Expansion Joints

1. Special types of expansion joints may be used when specified on the Plans or in the Special Provisions.

702.4.18 Encased or Supported Pipes and Conduits

1. Furnish and place pipes and conduits encased in the concrete as shown on the Plans or as specified in the Special Provisions without compensation unless otherwise specified.
2. In cases where the Department has authorized the placement of public utilities on a structure, the necessary pipes or conduits and any devices for supporting such utilities will be furnished by the owners of the utilities involved. Place such supporting devices without extra compensation unless otherwise specified on the Plans and/or in the Special Provisions.

702.4.19 Weep Holes and Drains

702.4.19.1 General

1. Locate and construct weep holes and drains or grates as indicated on the Plans or as directed by the RCE. No additional compensation will be made for such work. No deduction in measurement of concrete is made for these openings.

702.4.19.2 Weep Holes and French Drains for Box Culverts

1. When called for on the Plans, construct weep holes and French drains as described herein in box culverts that have inside vertical dimensions of 6 feet or greater. Provide 3-inch diameter weep holes in the outside walls of culverts and wingwalls at intervals of about 8 feet at an elevation of about 12 inches above the estimated normal water elevation. Cover the inside face of the weep hole with a 12 inch x 12 inch square of fiberglass or plastic mesh or grid that allows water to pass freely, but prevents the loss of the aggregate. Connect the weep holes with 12-inch square French drains constructed with aggregate conforming to Aggregate No. 5 or 57.

702.4.19.3 Weep Holes and French Drains in Retaining Walls

1. Construct weep holes in retaining walls with a height of 6 feet or more above footing. Space the holes approximately 20 feet on centers, or as shown on the Plans, and locate at or slightly above finished ground line elevation on the exposed side of the wall. Provide 3-inch diameter weep holes unless otherwise specified. Cover the inside face of the weep hole with a 12 inch x 12 inch square of fiberglass or plastic mesh or grid that allows water to pass freely, but prevents the loss of the aggregate. Connect the weep holes with 12-inch square French drains. In addition, extend 12-inch square French drains vertically above each weep hole to within 2 feet of the top of the retaining wall. Construct the French drains with aggregate conforming to Aggregate No. 5 or 57.

702.4.20 Bridge Sidewalks and Curbs

1. Take utmost care in placing and finishing curbs and sidewalks. Ensure that they are placed true to line and grade and meet ADA requirements. Screed, float, and finish the surface in a manner satisfactory to the RCE.

702.4.21 Widening Existing Concrete Structures

1. Dimensions of new construction on a widening project are subject to existing conditions, therefore, field verify all dimensions before ordering beams and performing any work on existing bridges. Make at least three profile line surveys of the existing bridge decks at the locations determined by the RCE. Make the profile line surveys at 5-foot intervals and determine elevation to the nearest 0.002 of a foot. Use identical stations for all surveys in order to facilitate survey comparisons. Compare the cross slope, bridge grades, and stationing of the actual surveys with the widening Plans to aid in determining the amount of necessary adjustments needed to eliminate any conflicts and improve the alignment of the new structure with respect to the existing structure.
2. Anticipate having to perform grinding and texturing of the deck in order to meet the longitudinal rolling straightedge, rideability, and transverse straightedge requirements as specified in **Subsection 702.4.14**. Check the depth of the concrete cover over the reinforcing steel and limit the proposed grinding and texturing accordingly. For each structure, submit to the RCE for review and acceptance the following:
 - All plotted survey profiles,
 - Proposed grinding and texturing procedures,
 - Proposed grinding depths,
 - Existing concrete cover information,
 - Proposed finished grades, and
 - Proposed substructure elevations and stationing.

3. Include all costs of the abovementioned work, except grinding and texturing, in the lump sum price bid for Construction Stakes, Lines, and Grades, which includes all materials, labor, equipment, tools, and traffic control.
4. When casting new concrete against existing concrete, clean the contact surface of the existing concrete of all loose concrete, dirt, oil, grease, and any other deleterious material to the satisfaction of the RCE. In addition, before placing the new deck slab concrete, sawcut the edge of the existing deck slab (1 inch minimum) to give a straight line to tie into. Thoroughly roughen to an amplitude of ¼ inch just before casting the new concrete. Also, just prior to casting the new deck concrete, coat the portion of the existing slab from the top surface down to the top layer of reinforcing steel with a bonding epoxy conforming to ASTM C 881, Type II. Apply bonding epoxy in accordance with the manufacturer's written recommendations.
5. If feasible, embed in the new concrete all reinforcing steel protruding beyond the existing concrete surface after removal of the designated portion of the existing concrete. Unless a concrete overlay is used, cut off reinforcing steel that cannot be embedded in the new concrete to 1 inch below the existing concrete surface and patch the resulting hole with an epoxy-sand grout accepted by the BCE. When an overlay is used, cut off the reinforcing steel that cannot be embedded flush with the surface of the concrete.
6. Include the entire cost of removal and disposal of designated portions of existing bridge, including all drilling and chipping necessary to construct the new structure in the lump sum price bid for Removal and Disposal of Designated Portions of Existing Bridges.
7. At no expense to the Department, repair or replace in a manner satisfactory to the BCE any portion of the existing structure damaged by the Contractor's operations. Any other necessary repairs to the existing structure that are not called for in the Plans, and in the opinion of the BCE are needed, are paid as extra work.

702.5 Measurement

1. Measurement for work for concrete items described in this section is not made under this section. Measurement is made in accordance with other sections of these specifications that govern the items of work included in the concrete structure. No separate measurement is made for stay-in-place (SIP) steel bridge deck forms. Include all the cost of materials, labor, equipment, tools, supplies, and incidentals necessary to furnish and install permanent steel bridge deck forms in the contract unit bid price for the concrete item.
2. Measurement for the quantity of concrete in the bridge slabs is computed from the neat line dimensions shown on the Plans with no allowance for form deflection. No additional payment is made for extra concrete required by the use of permanent steel bridge deck forms or for the SIP forms themselves.
3. Unless otherwise specified herein, on the Plans, or in the Special Provisions, joints are not measured for separate payment. Include all materials, labor, equipment, tools, supplies, and incidentals necessary to furnish and install expansion joints, except deck joint strip seals, in the contract unit bid price for deck slab concrete.
4. Deck joint strips seals are measured and paid for in accordance with **Subsections 723.5 and 723.6.**

5. The quantity for the pay item Grooved Surface Finish is the surface area of the bridge deck provided with the grooved finish and is measured by the square yard (SY), complete, and accepted. Deck area not grooved is not included in the measurement.
6. There is no measurement for payment for grinding and texturing of new bridge decks to correct irregularities and excess deviations that are the fault of the Contractor. The quantity for the pay item Grinding and Texturing Concrete Bridge Deck for the removal or correction of irregularities and excessive deviations at the junction of new and existing bridge deck slabs is measured by the square yard (SY) of deck area ground and textured, complete, and accepted.

702.6 Payment

1. No separate payment, except as noted below, is made for compliance with this section. Consider all costs of the work described in this section incidental to the project and included in other items of work.
2. If the RCE requires inspection and certification of any falsework system by a South Carolina registered Professional Engineer as described in **Subsection 702.4.1.4.3**, payment will be made by Change Order. However, if the inspection reveals that the falsework system does not comply with the Working Drawings, no payment is due.
3. Payment for the accepted quantity of Grooved Surface Finish, measured in accordance with **Subsection 702.5**, is determined using the contract unit bid price for the pay item. Payment is full compensation for providing a grooved surface finish as specified or directed and includes cutting grooves into the harden concrete deck; removing and disposing of the debris; and all other materials, labor, equipment, tools, supplies, transportation, and incidentals necessary to fulfill the requirements of the pay item in accordance with the Plans, the Specifications, and other terms of the Contract.
4. Payment for the accepted quantity for Grinding and Texturing Concrete Bridge Deck, measured in accordance with **Subsection 702.5**, is determined using the contract unit bid price for the pay item. Payment is full compensation for removing or correcting irregularities and excessive deviations at the junction of new and existing bridge deck slabs and all other materials, labor, equipment, tools, supplies, transportation, and incidentals necessary to fulfill the requirements of the pay item in accordance with the Plans, the Specifications, and other terms of the Contract.
5. Pay items under this section include the following:

| Item No. | Pay Item | Unit |
|----------|--|------|
| 7023200 | Grooved Surface Finish | SY |
| 7028000 | Grinding and Texturing of Concrete Bridge Deck | SY |

Appendix A

| Gradation of Coarse Aggregates | | | | | | | | | | | | |
|---|----------------------|----------|-----------|-----------|-----------|-----------|-----------|-----------|------------|------------|----|-----|
| Percentage by Weight Passing Sieves Having Square Openings | | | | | | | | | | | | |
| Sieve Designation | Aggregate No. | | | | | | | | | | | |
| | CR-14 | 5 | 56 | 57 | 67 | 6M | 8M | 78 | 789 | 89M | | |
| 2-inch | 100 | -- | -- | -- | -- | -- | -- | -- | -- | -- | -- | -- |
| 1½-inch | 95 - 100 | 100 | 100 | 100 | -- | -- | -- | -- | -- | -- | -- | -- |
| 1-inch | 70 - 100 | 90 - 100 | 90 - 100 | 95 - 100 | 100 | 100 | -- | -- | -- | -- | -- | -- |
| ¾-inch | -- | 20 - 55 | 40 - 85 | -- | 90 - 100 | 90 - 100 | 100 | 100 | 100 | -- | -- | -- |
| ½-inch | 35 - 65 | 0 - 10 | 10 - 40 | 25 - 60 | -- | -- | 95 - 100 | 90 - 100 | 95 - 100 | 100 | -- | 100 |
| ⅜-inch | -- | 0 - 5 | 0 - 15 | -- | 20 - 55 | 0 - 20 | 75 - 100 | 40 - 75 | 80 - 100 | 98 - 100 | -- | -- |
| No. 4 | 10 - 40 | -- | 0 - 5 | 0 - 10 | 0 - 10 | 0 - 5 | 10 - 35 | 5 - 25 | 20 - 50 | 20 - 70 | -- | -- |
| No. 8 | -- | -- | -- | 0 - 5 | 0 - 5 | -- | -- | -- | -- | 2 - 20 | -- | -- |
| No. 16 | -- | -- | -- | -- | -- | -- | 0 - 5 | 0 - 5 | 0 - 6 | -- | -- | -- |
| No. 100 | -- | -- | -- | -- | -- | -- | 0 - 2 | -- | 0 - 2 | 0 - 3 | -- | -- |

| Gradation of Fine Aggregates | | | | |
|---|----------------------|---------------|--------------|--------------|
| Percentage by Weight Passing Sieves Having Square Openings | | | | |
| Sieve Designation | Aggregate No. | | | |
| | FA-10 | FA-10M | FA-12 | FA-13 |
| ½-inch | -- | -- | -- | -- |
| ⅜-inch | 100 | 100 | 100 | 100 |
| No. 4 | 96 - 100 | 95 - 100 | 90 - 100 | 90 -100 |
| No. 8 | 75 - 100 | 84 - 100 | -- | -- |
| No. 16 | 55 - 98 | 45 - 95 | 50 - 86 | 40 - 80 |
| No. 30 | 25 - 75 | 25 - 75 | -- | -- |
| No. 50 | 5 - 30 | 8 - 35 | 2 - 20 | 0 - 10 |
| No. 100 | 0 - 9 | 0.5 - 20 | 0 - 5 | 0 - 3 |
| No. 200 | 0 - 3 | 0 - 10* | -- | -- |

* Dust of fracture essentially free from clay or shale, final job site testing only.

| Aggregate Applications | |
|-------------------------------|---|
| Aggregate No. | Applications |
| 5 | Asphalt Surface Treatment - Double Treatment -Types 1 & 2 Asphalt Surface Treatment - Triple Treatment - Type 1 |
| 6M | Asphalt Surface Treatment - Single Treatment - Types 1 & 2 Asphalt Surface Treatment - Double Treatment - Types 3 & 4 Asphalt Surface Treatment - Triple Treatment - Type 2 |
| 57 | Portland Cement Concrete for Structures |
| 67 | Portland Cement Concrete Pavement |
| 89M | Asphalt Surface Treatment - Single Treatment Asphalt Surface Treatment - Double Treatment - Types 4 & 5 Asphalt Surface Treatment - Triple Treatment - Type 2 |
| 789 | Aggregate underdrains Asphalt Surface Treatment -Single Treatment Asphalt Surface Treatment - Double Treatment - Types 1, 2, & 3 Asphalt Surface Treatment - Triple Treatment - Type 1 Pipe underdrains |
| CR-14 | Soil-Aggregate Subbase |
| FA-10 FA-10M | Portland Cement Concrete for Structures Portland Cement Concrete Pavement |
| FA-12 | Aggregate Underdrains |
| FA-13 | Aggregate Underdrains Asphalt Surface Treatment - Double Treatment - Type 5 Asphalt Surface Treatment - Triple Treatment - Types 1 & 2 |

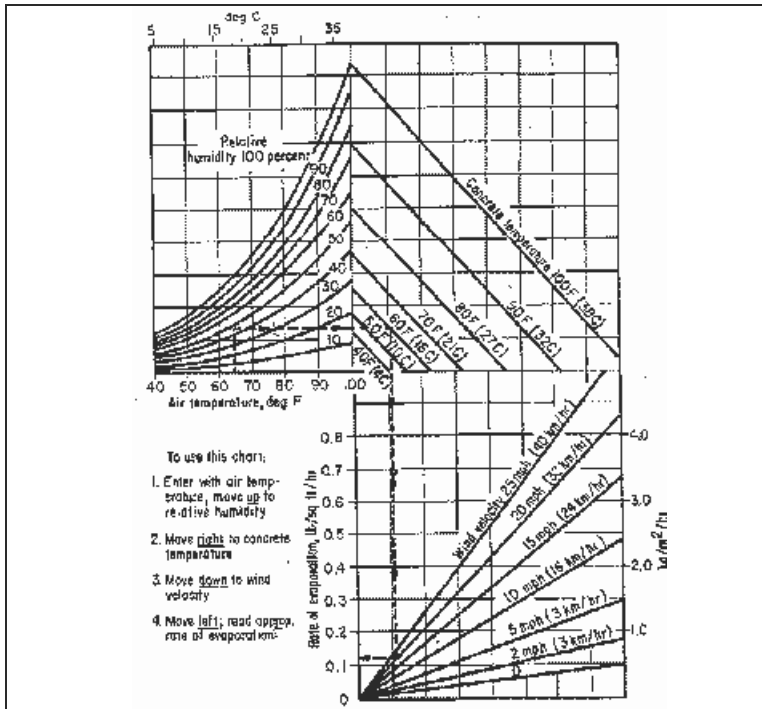

Nomograph for Determining Rate of Evaporation

This chart provides a graphic method of estimating the loss of surface moisture due to concrete and air temperatures, relative humidity, and wind velocity. To use the chart, follow the four steps outlined. If the rate of evaporation approaches 0.2 lbs./ft.²/hr., precautions against plastic shrinkage cracking are necessary.

Chapter 9

SCDOT 2007 Standard Specifications for Highway Construction

Section 703: Reinforcing Steel

Section 703 – Reinforcing Steel

QPL 60

Rebar Equivalency Chart

STANDARD SPECIFICATIONS: 703 Reinforcing Steel

(CHAPTER 9)



703 REINFORCING STEEL



703 REINFORCING STEEL

703.1.2 Production of Iron and Steel Products on Federal Aid Projects

On federal-aid projects, use only iron and steel products, including tie wire and supports for reinforcing steel and coatings, for which the manufacturing processes occurred in the United States in accordance with **Subsection 106.11**.

Materials 703.2.1 – 2.6

Covers: Reinforcing Bars, Wire and Wire Fabric, Galvanized Rebar, Mechanical Couplers, Ultimate Butt-Welded Splices, Bar Supports



Rebar Splices

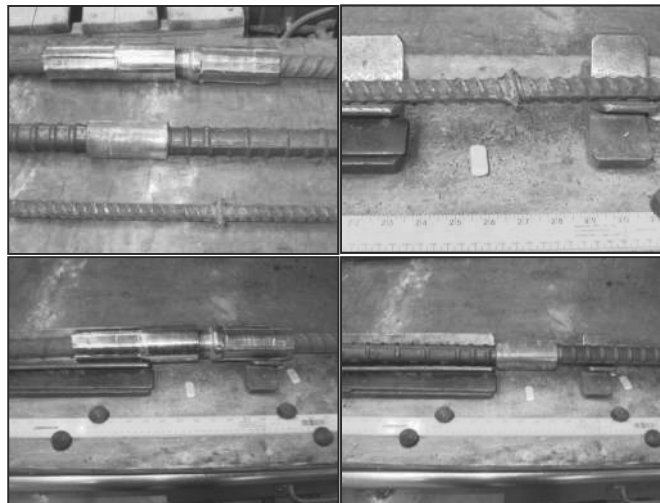

Reinforcement Bar Acceptance

QUESTIONS: What is the criteria for Reinforcement Bar Acceptance? What sample size is needed and who can perform the testing? What Grade of Steel is required?

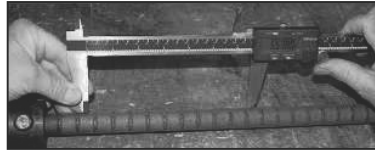

SCDOT



UNIVERSITY OF
South Carolina

QPL 60

The Office of Materials and Research has recently updated the reinforcing steel Qualified Product List.

The new QPL can be found here:

<http://www.scdot.org/doing/ConstructionDocs/pdfs/Materials/60%20QPL%20071911.pdf>

Changes were made in response to some issues that were noted involving samples that were submitted to the OMR on SCDOT projects.



SCDOT

UNIVERSITY OF
South Carolina

Sampling Rebar for SCDOT Projects:

Section 703.2.1 Standard Specifications must be ASTM A 706 and also from a source shown on QPL 60.

W or SW meets specifications for A 706.

S is A615 ONLY Concrete Pavement (Section 501.2.7 Standard Specifications).

- Is Producer Supplier on QPL? *If not, Contact Aly.*
- Is Rebar A706 and marked with a W?
- Is Rebar Grade 420/Grade 60? *(Marked with 4, 60, or extra deformation)*
- Does your sample bar have the rolled in mill markings? *If you sample from a bar that is not marked, please not the markings that are on the other bars in the same shipment.*



QUALIFIED PRODUCT LIST 60
January 10, 2022
Page 1 of 6

SOUTH CAROLINA DEPARTMENT OF TRANSPORTATION

Qualified Suppliers of Reinforcing Steel

These Producers are qualified in accordance with SCDOT Qualified Product Policy 60. Trade names are registered trademarks of the appropriate company.

| SCDOT PRODUCER CODE | Producer | Contact /Telephone |
|-----------------------------|---|--|
| SteelRebarCo005 (CMCCSC) | CMC Steel South Carolina 310 New State Road Cayce, SC 29033 | Clyde Ditolla (803) 936-3867 Clyde.ditolla@cmc.com |
| SteelRebarCo029 (CMCDOK) | CMC Steel Oklahoma 584 Old Highway 70 Durant, OK 74702 | Robbie Booth (480) 396-7127 Robert.booth@cmc.com |
| SteelRebarCo002 (CMCJFL) | CMC Steel Florida 16770 Rebar Road Jacksonville, FL 32234 | Alex Renosto (904) 266-1468 alexander.renosto@cmc.com |
| SteelRebarCo003 (CMCKTN) | CMC Steel Tennessee 1919 Tennessee Avenue Knoxville, TN 37921 | Jim Hall (865) 202-5972 James.Hall@cmc.com |



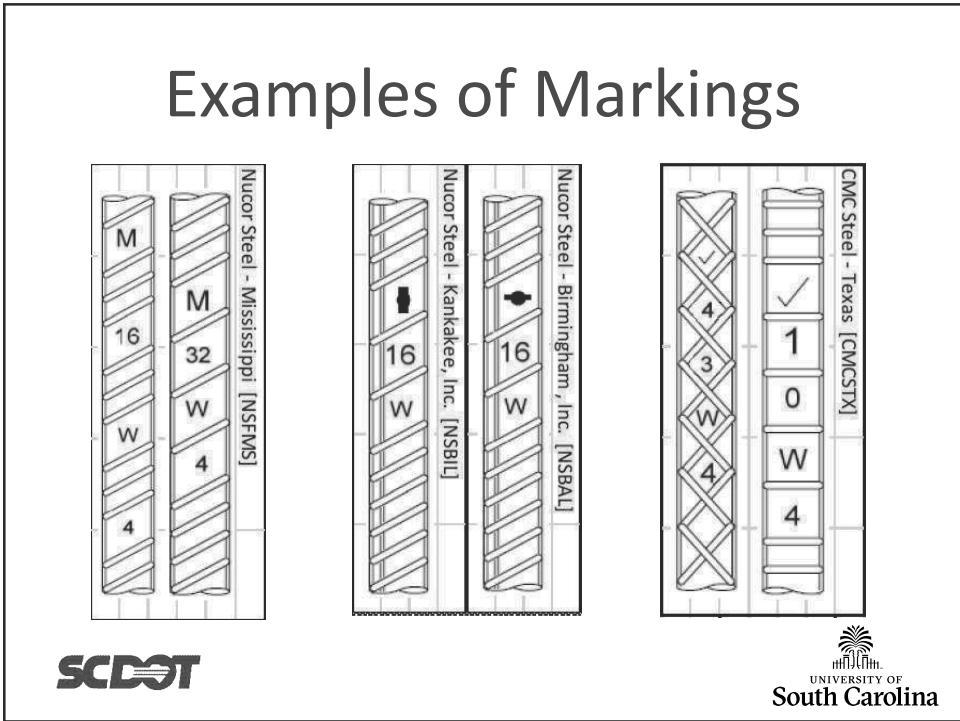
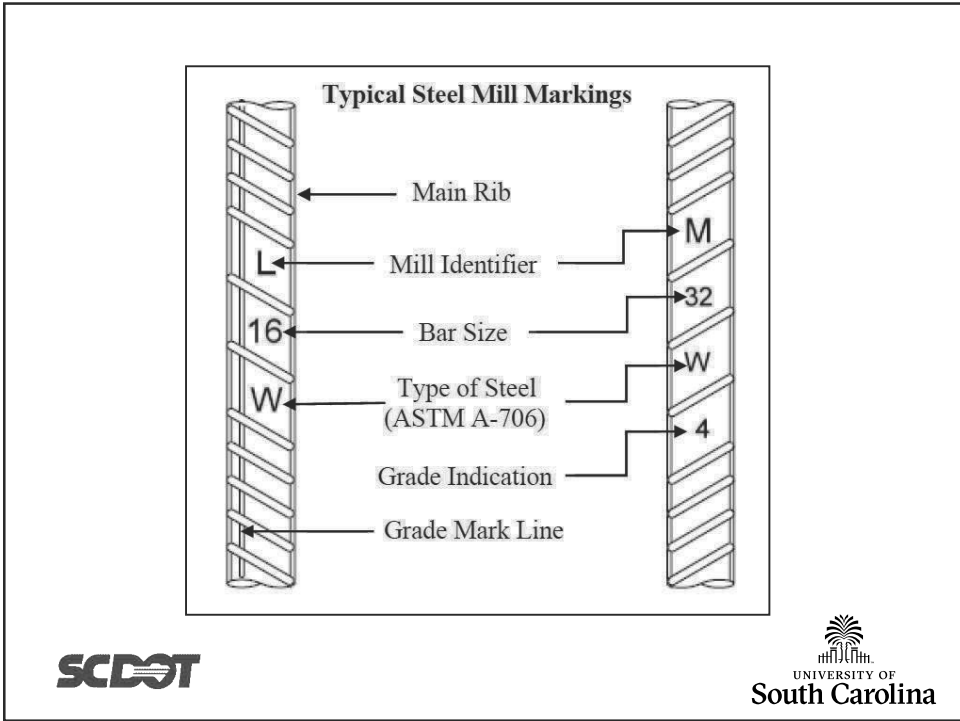

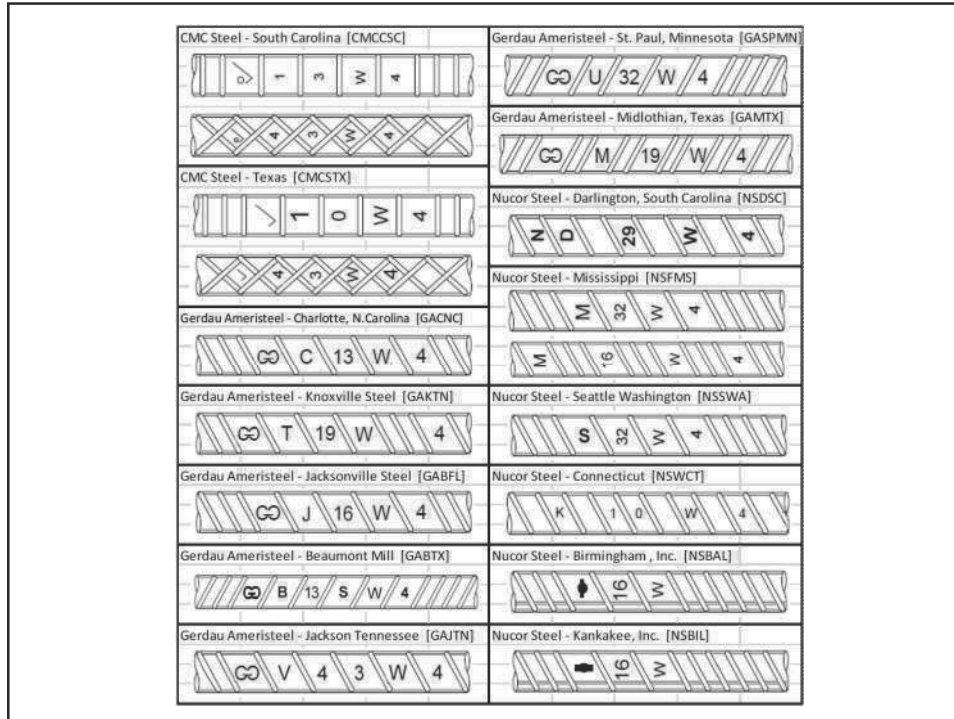

Metric VS. Standard Units

| BAR SIZE (SI) | DIAMETER (in) | BAR SIZE (METRIC) | DIAMETER (mm) |
|---------------|---------------|-------------------|---------------|
| #3 | 0.375 | 10 | 9.5 |
| #4 | 0.500 | 13 | 12.7 |
| #5 | 0.625 | 16 | 15.9 |
| #6 | 0.750 | 19 | 19.1 |
| #7 | 0.875 | 22 | 22.2 |
| #8 | 1.000 | 25 | 25.4 |
| #9 | 1.128 | 29 | 58.7 |
| #10 | 1.270 | 32 | 32.3 |
| #11 | 1.410 | 36 | 35.8 |
| #14 | 1.693 | 43 | 43.0 |



Directive from OMR

PLEASE NOTE: Samples submitted from an unapproved source and/or have markings indicating that the steel is A615 will not be tested and a test report will indicate FAILURE.



Rebar Identification

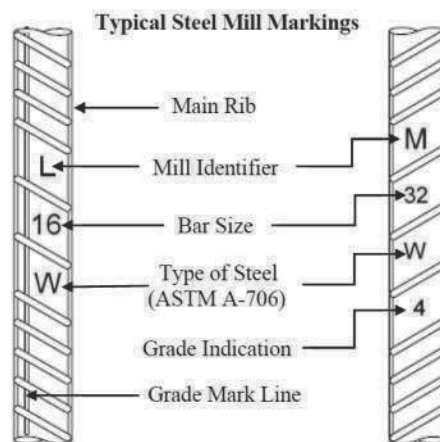

Rebar Identification

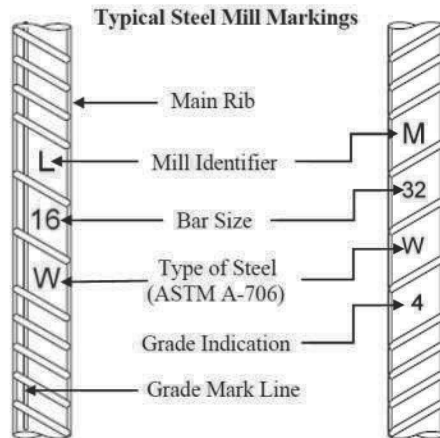

Rebar Identification

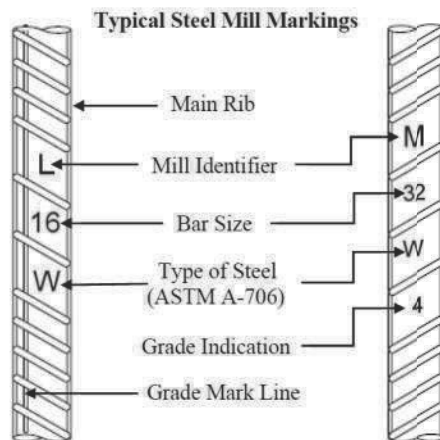

Rebar Identification

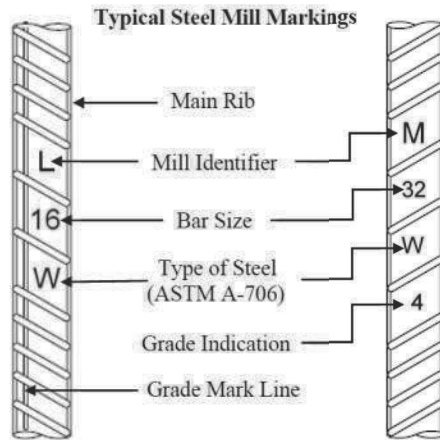

703 REINFORCING STEEL

703.3 Equipment

703.4.1 – 4.4 Construction

Covers: Protection of Materials, Bending, Placing and Fastening, Splicing of Bars

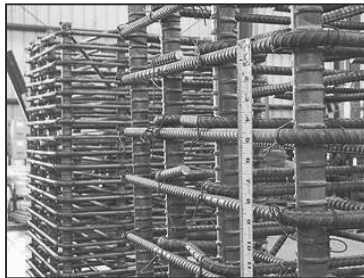

Protection of Rebar

QUESTION: How high must rebar be stored off the ground?



Rebar Support Chairs



SCDOT

UNIVERSITY OF
South Carolina

Quality Assurance

QUESTIONS:

What size samples are needed for mechanical couplers and ultimate butt – welded splices (UBWS)?

Who is in charge of inspection of mechanical couplers on the project?

SCDOT

UNIVERSITY OF
South Carolina

Quality Assurance

QUESTIONS:

What size samples are needed for mechanical couplers and ultimate butt – welded splices (UBWS)?



Quality Assurance

QUESTION:

Who is in charge of inspection of mechanical couplers on the project?



QUESTION:

When are concrete blocks allowed for rebar support?



SECTION 703

REINFORCING STEEL

703.1 Description

703.1.1 General

1. This section contains specifications for materials, equipment, construction, measurement, and payment for furnishing and placing reinforcing steel consisting of bars, wire, wire mesh, bar supports, and ties.

703.1.2 Production of Iron and Steel Products on Federal Aid Projects

1. On federal-aid projects, use only iron and steel products, including tie wire and supports for reinforcing steel and coatings, for which the manufacturing processes occurred in the United States in accordance with **Subsection 103.11**.

703.2 Materials

703.2.1 Reinforcing Bars

1. Provide reinforcing bars (rebar) and dowels that meet the requirements of ASTM A 706 with a minimum single yield strength level of 60,000 psi, designated as Grade 60 and are from a source listed on the most recent edition of *SCDOT Qualified Product List 60*. Acceptance or rejection of all reinforcing steel is based on 30-inch long samples taken in the field and tested by the OMR or an OMR authorized AASHTO accredited testing laboratory.

703.2.2 Wire and Wire Fabric

1. Provide wire for concrete reinforcement, either as such or in fabricated form, conforming to AASHTO M 32 or AASHTO M 225. Provide welded steel wire fabric for concrete reinforcement meeting the requirements of AASHTO M 55.

703.2.3 Galvanized Reinforcing Bars

703.2.3.1 Use and Production

1. Use zinc-coated galvanized deformed steel reinforcing bars in structural concrete where shown on the Plans and extend it to the limits shown. Provide zinc-coated reinforcing steel in structures that is hot-dip galvanized in accordance with ASTM A 767, Class II, 2 ounces per square foot with a minimum thickness of 3.5 mils. Galvanize the steel bars after fabrication.
2. Do not use reinforcing steel produced by water quenching method.

703.2.3.2 Repair of Galvanized Reinforcing Steel

703.2.3.2.1 Shop Repair

1. Reject zinc-coated reinforcing steel bars that do not meet the requirements above and do not repair such reinforcing steel bars.

703.2.3.2.2 Field Repair

1. Field repair damaged areas of the rebar coating and replace bars exhibiting severely damaged coatings. Make certain that the field repair material has a minimum of 65% zinc by weight. Provide a minimum repair coating thickness of 3.5 mils.

2. The RCE and/or BCE will be the sole judges of the severity of damaged areas for purposes of repair or replacement. Do not incorporate into the work any reinforcing bar having a coating determined by the RCE and/or BCE to be severely damaged. Remove such rebar from the work site. Replace the damaged rebar in kind at no additional cost to the Department.

703.2.3.3 Handling, Placing, and Fastening

1. Provide systems for handling galvanized coated bars that have padded contact areas for the bars, wherever possible. Pad all bundling bands and lift all bundles with multiple supports or a platform bridge to prevent bar to bar abrasion from sags in the bar bundle. Do not drop or drag the bars or bundles. Flame cutting of the ends of reinforcing steel is allowable if requested, and such request is reviewed and approved by the RCE. Grind/trim ends of flame cut bars to remove any burrs and/or sharp edges before field coating.
2. Provide galvanized tie wire in accordance with AASHTO M 232, Class D or stainless steel. Ensure that chairs and reinforcing steel supports are plastic in Zone A (as defined in **Subsection 703.2.6.1**) and plastic or galvanized in Zone B. Have the specific hardware intended for use approved by the BCE.

703.2.4 Mechanical Couplers for Reinforcing Steel

703.2.4.1 General

1. Ensure that all mechanical coupler components are compatible with the reinforcing bars specified in this subsection and that all splices with the mechanical couplers are made as specified and detailed on the Plans. In selecting a coupler, consider the clearance requirements for correct installation and proper alignment of the reinforcing after installation.

703.2.4.2 Quality Control Manager

1. Designate in writing, to the RCE, a Quality Control Manager (QCM) for all mechanical couplers. The QCM is responsible for the quality of the mechanical coupler splicing, including the inspection of materials and workmanship and for submitting, receiving, and approving all correspondence, required submittals, and reports to and from the RCE. The QCM may be an employee of the Contractor.

703.2.4.3 Material Information and Certification

1. Provide from the coupler manufacturer a description of the device, including dimensions, designations, material specifications, and the method of packaging and identification. Ensure that the couplers develop at least 125% of the actual yield strength of the control bar under the static tension test. When Ultimate Couplers are required, ensure that mechanical couplers develop ultimate butt splice connection strength under the static tension test of 100% of the specified tensile strength of the bar. Additionally, supply to the RCE detailed installation instructions from the mechanical coupler manufacturer for each type of mechanical coupler being used. Obtain the information required above in a document from the manufacturer certifying that the product meets the applicable SCDOT specifications.

703.2.4.4 Manufacturer's Quality Control Testing Facility and Reports

703.2.4.4.1 General

1. Ensure that all manufacturer quality control testing is performed in a laboratory that has been reviewed and accepted by the SME representative or has been satisfactorily inspected by AASHTO Materials Reference Laboratory (AMRL) for all applicable tests. Ensure that the qualified laboratory used to perform the manufacturer's quality control testing of all splices and control bars meets and complies with the requirements of **Subsections 703.2.4.4.2 through 703.2.4.4.5**.

703.2.4.4.2 Facilities

1. Ensure that the qualified laboratory has a tensile testing machine capable of breaking the largest bar requiring testing.

703.2.4.4.3 Markings

1. Ensure that the reinforcing bars are marked in such a way to measure any slippage across the splice.

703.2.4.4.4 Operators

1. Ensure that the machine operators have received formal training and are certified to perform the testing in conformance with ASTM A 370.

703.2.4.4.5 Calibration

1. Ensure that the qualified laboratory has a record of annual calibration of testing equipment performed by an independent third party that has standards that are traceable to the National Institute of Standards and Technology (NIST) and has a formal reporting procedure, including published test forms.

703.2.4.4.6 Test Reports

1. Ensure that the qualified laboratory submits test reports that include the following:
 - Sampling Procedures,
 - Test specimen preparation procedures,
 - Test procedures, and
 - Results of all tests performed.

703.2.4.5 Quality Control (QC) Test Requirements

1. A lot of mechanical couplers is defined as 150, or fraction thereof, of the same type of mechanical couplers used for each bar size and each bar deformation pattern that is used in the work. Test sample splices in conformance with these specifications and the requirements of ASTM A 370.
2. For all mechanical couplers testing performed, in accordance with the test criteria, test in tension an unspliced control reinforcing bar of each size used in order to establish the actual yield and ultimate stress values and strain in the bar at actual yield stress. Ensure that for any bar group, all bars used for testing are from the same heat number. After all of the splices in a lot have been completed, provide the RCE with written statement from the QCM stating that all couplers in this lot conform to the specifications.

703.2.4.6 Quality Assurance (QA) Test Requirements

1. For each lot of each splice size, two complete samples of couplers with reinforcing bars of the same heat numbers that are being used in the work and one control bar from that same heat will be randomly obtained at the project site by the SCDOT inspector and submitted to the OMR for testing. Ensure that complete reinforcing bars with coupler splice samples and control bar samples are a minimum length of 30 inches long and are accompanied by a Certified Mill Test Report for the control bar's heat number. In the event one sample fails, submit a check sample of two couplers for testing.

703.2.4.7 Handling and Storage

1. Protect exposed threaded bars on staged work by installing the threaded coupler on the in-place bar and capping the open end of the coupler. Immediately before installation, check the threads and ease of rotation of any threaded parts of couplers to detect contamination that could cause blinding. Regardless of the method of mechanical coupling used, prevent damage to or contamination of the reinforcing or coupling devices that will inhibit or negatively affect the certified behavior of the device. If in the opinion of the RCE, such damage or contamination exists, replace the reinforcing, couplers, or both, or remove the contamination to the satisfaction of the RCE at no additional time or cost to the Department. In the choice of couplers, consider the clearance requirements for correct installation and proper alignment of the reinforcing after installation.

703.2.5 Ultimate Butt-Welded Splices (UBWS)

703.2.5.1 Material

1. Use UBWS containing steel that conforms to the requirements of **Subsection 703.2.1** and is from a manufacturer (mill) listed on the most recent edition of *SCDOT Qualified Product List 60*.

703.2.5.2 Fabricator Pre-Job Test Requirements

1. Before incorporation into the work, ensure that Ultimate Butt Welded Splices are fabricated in conformance with the following pre-job test requirements:
 - a. Notify the OMR at least 14 calendar days before beginning production for the project so that a source visit can be arranged. The OMR will make random visits to the fabricator during production.
 - b. Obtain 4 pre-job sample splices and 4 control bars (total of 8 bars for 1 set) for each bar size UBWS that will be used in the work.
 - c. Fabricate the sample splices using the same splice materials, position, operators, location, and equipment, and following the same procedures that will be used to make the splices in the work.
 - d. Perform all fabricator pre-job testing in a laboratory that has been reviewed and accepted by the OMR.

- e. Make certain that all sets of UBWS from each pre-job test conform to the test criteria specified herein. For each set, obtain a pre-job test report prepared by the laboratory performing the tests. Have the official, who represents the laboratory and accepts the responsibility for the report's contents, sign the report. Ensure that the report contains, as a minimum, the following information for each set:
 - SCDOT Contract No.,
 - SC File No.,
 - Bar size,
 - Type of splice,
 - Physical condition of test sample splice and control bar,
 - Any notable defects,
 - Limits of heat affected zone,
 - Location of visible necking area,
 - Ultimate strength of each splice,
 - Ultimate strength and 95% of this ultimate strength for each control bar,
 - Actual yield strength of each control bar, and
 - Comparison between 95% of the ultimate strength of each control bar and the ultimate strength of its associated splice.
- f. Submit the pre-job test report to the OMR and the RCE for review and acceptance.

703.2.5.3 Quality Assurance (QA) Test Requirements

703.2.5.3.1 General

1. A UBWS lot is defined as a shipment of the same type of UBWS used for each bar size and each heat number that is used in the work. Test samples in accordance with **Subsection 703.2.5.3.4**.
2. Perform QA tests for all UBWSs used in the work. A QA test is considered as a sample splice and corresponding control bar removed from each lot of completed splices at the project site. The RCE will randomly select the sample splices to be removed from the lot and the associated control bar. Remove the sample splice and obtain the control bar in the presence of the RCE. Obtain all samples requested by the RCE at no additional cost.

703.2.5.3.2 Test Sample Requirements

1. A test sample of UBWSs will be randomly selected at the project site for each size and shipment of material for the work. Make certain that each sample is
 - A minimum of 30 inches in length with the splice located at mid-point,
 - Accompanied by a Certified Mill Test Report for that bar's heat number, and
 - Suitably identified before shipment with weatherproof markings.

703.2.5.3.3 Control Sample Requirements

1. Provide one control bar from the same bar lot as the test sample splice. Make certain that the control bars are
 - A minimum of 30 inches in length, and
 - Suitably identified before shipment with weatherproof markings.

2. Identify and mark each sample splice and its associated control bar as a set. When a portion of any hoop reinforcing bar is removed from assembled cages or columns to obtain a sample splice and control bar, replace the removed portion using a pre-qualified Ultimate Mechanical Butt Splice, or replace the hoop in kind.
3. Securely bundle together the set from each QA test and identify the bundle with a completed sample identification card before shipment for testing. Bundles of samples not containing a complete set of one sample splice and one associated control bar will not be tested. Submit a copy of the manufacturer's Certified Mill Test Report with each sample set.
4. Ensure that all sample test results are satisfactory before encasing any splices in concrete. If any splices are encased before receiving notification from the RCE, it is expressly understood that any material not conforming to these specified requirements will be subject to rejection, and the replacement of removed material will be at the no expense to the Department.

703.2.5.3.4 Test Criteria

1. Test the tensile strength of sample splices in conformance with the requirements described in ASTM A 370. Make certain that sample splices ruptures in the reinforcing bar either
 - Outside of the heat-affected zone, or
 - Within the heat-affected zone, if the sample has achieved at least 95% of the ultimate tensile strength of the control bar associated with the sample.
2. In addition, ensure that necking of the bar is visibly evident at rupture regardless of whether the bar breaks inside or outside the heat-affected zone. The heat-affected zone is the portion of the reinforcing bar where any properties of the bar, including the physical, metallurgical, or material characteristics, have been altered by fabrication or installation of the splice.
3. Determine the ultimate tensile strength of each control bar by tensile testing the bar to rupture. Test the ultimate tensile strength for all applicable control bars, regardless of where each sample splice ruptures. Test sample splices for ultimate strength and the corresponding control bars for yield and ultimate strength.
4. Any material not conforming to the requirements herein will be subject to rejection. If the sample splice or control bar fail to conform to these provisions, all splices in the lot represented by the QA tests will be rejected.
5. If the sample splice and control bar from a QA set passes, all splices in the lot will be considered acceptable.
6. Do not mix or combine the lots of UBWSs being tested before the successful completion of the QA tests.

703.2.5.4 Corrective Action

1. Whenever a lot of UBWSs is rejected, fulfill the following requirements before using additional UBWSs in the work:
 - Perform a complete review of the producer's quality control process for these splices.
 - Submit a written report to the OMR describing the cause of failure for the splices in this lot and provisions for correcting the failure in future lots.
 - Ensure that the OMR has provided the RCE notification that the report is acceptable. The OMR will have at least 10 calendar days to review the report and

notify the RCE of the report's status. The RCE will have at least 5 calendar days after notification to determine the course of action for the project.

2. If a QA test for any lot fails, replace all reinforcing bars representing failing sample splices before the RCE selects additional splices from the replacement lot for further testing.
3. When sampled bars are repaired with a pre-qualified Ultimate Mechanical Butt Splice as described in **Subsection 703.2.5.3**, QA tests are not required on the repaired splices.

703.2.6 Bar Supports

703.2.6.1 General

1. Unless otherwise approved in writing by the BCE, utilize plastic bar supports in lieu of wire bar supports in Zone A, which consists of Beaufort, Berkeley, Charleston, Colleton, Dorchester, Georgetown, Horry, and Jasper Counties.
2. Wire bar supports or plastic bar supports may be utilized in Zone B, which consists of all counties not in Zone A.
3. Provide bar supports for galvanized rebar as specified in **Subsection 703.2.3.3**.

703.2.6.2 Wire Bar Supports

1. Ensure that the wire bar supports comply with standard type and classes of protection as specified in the *CRSI Manual of Standard Practice* unless noted otherwise in this subsection, on the Plans, or in the Special Provisions. Space wire supports to provide adequate support for slab reinforcing steel.
2. For flat slab spans, support the lower layer of slab steel with Beam Bolster (BB) bar supports. Place 1 row near each end of span with interior rows spaced approximately 24 inches on centers.
3. For beam spans, support the lower layer of slab steel withy Beam Bolster (BB) bar supports spaced approximately 36 inches on centers with a minimum of three rows between longitudinal beams and one row on each overhang placed not more than 12 inches from edge of slab. Ensure that the BB bar supports have Class 1 maximum protection, unless shown otherwise in the Plans. Support top reinforcing bars by Continuous High Chairs Upper (CHCU) bar supports or Beam Bolster Upper (BBU) bar supports as shown on the Plans and spaced a maximum of 30 inches on centers.
4. Provide tie wire galvanized in accordance with AASHTO M 232, Class D or stainless steel, for use with galvanized bars. Use black tie wire for non-galvanized bars.

703.2.6.3 Plastic Bar Supports

1. Ensure that plastic bar supports meet the following requirements:
 - a. Chairs and bolsters are of adequate strength to resist a 300 pound concentrated load without permanent deformation or breakage.
 - b. The plastic bar support material is manufactured from either resin or first generation recycled thermoplastic resin, is colored white, gray, or black, and is chemically inert in concrete.
 - c. Plastic reinforcing bar supports are in a configuration that does not restrict concrete flow and consolidation around and under the reinforcing bar support.

703.2.6.4 Concrete Blocks

1. When concrete is to be placed directly on soil, concrete blocks may be used to support reinforcing bars. Cast the blocks holding the lower reinforcing bars in position from concrete of the same materials and proportions as that used in the structure, and ensure that the blocks are properly cured. Do not use blocks over 6 inches in length. Place blocks to permit their ends to be covered with concrete. Do not use pebbles, pieces of broken stone or brick, metal pipe, or wooden blocks to support reinforcing bars.

703.3 Equipment

1. Ensure that the equipment necessary for the proper construction of the work is on site, in acceptable working condition, and approved by the RCE as to both type and condition before the start of work under this section. Provide sufficient equipment to enable prosecution of the work in accordance with the project schedule and completion of the work in the specified time.

703.4 Construction

703.4.1 Protection of Materials

1. Store steel reinforcement on platforms, skids, or other supports raised above the ground a minimum of 6 inches and protect it as far as practicable from mechanical injury, surface deterioration, and mud splatter. Place polyethylene sheeting or other acceptable material on the ground under the reinforcing steel and ground supports to minimize the possibility of mud splatter contamination. When placed in the work, ensure that steel reinforcement is free from loose or thick rust, dirt, scale, dust, paint, oil, concrete mortar, curing compound, or other foreign material. Ensure that the surface condition of the reinforcement is acceptable to the RCE before using it in the work.

703.4.2 Bending

1. Bend the reinforcement accurately to the shapes shown on the Plans. Utilize competent personnel for cutting and bending and provide the proper equipment for such work. Ensure that bar bending is performed in accordance with recommendations in the *CRSI Manual of Standard Practice*, unless otherwise shown on the Plans.
2. All dimensions relative to clearances are from the edge of the reinforcing steel to the edge of the concrete. All dimensions relative to spacing of reinforcing steel are from center to center of the bars. The overall length of the bars shown in the steel tables is the overall length of the bars along their centerlines after bending.
3. Provide finished bars conforming to the shapes and dimensions called for on the Plans and in the Special Provisions. Make any allowances necessary to account for creep in the bars during bending to secure the shapes and dimensions called for on the Plans and in the Special Provisions.

703.4.3 Placing and Fastening

1. Accurately place reinforcement, and during the placing and consolidation of concrete, firmly hold in the positions shown on the Plans. Maintain distances from the forms and between layers by means of concrete blocks, hangers, bolsters, or other approved supports complying with requirements of **Subsection 703.2.6**.

2. Hold the reinforcement together by tie wire at all intersections except where the spacing is 12 inches or less in each direction, in which case, tie alternate intersections. Hold bars projecting beyond a construction joint in place by templates during concreting to ensure proper position.
3. Before concrete is deposited in the forms, replace, adjust, or bend back any steel or wires that project nearer to the forms than specified by the Plans. Correct to the satisfaction of the RCE all reinforcement that is not in its proper position, properly wired, and clean as specified in **Subsection 703.4.1**. Do not deposit concrete until the RCE has inspected the condition of the reinforcing steel and given permission to place concrete. Unless otherwise provided or permitted by the BCE, do not place reinforcement into the concrete as the concrete is being placed.

703.4.4 Splicing of Bars

703.4.4.1 General

1. Furnish all reinforcement in the full lengths indicated on the Plans unless otherwise permitted. Except for splices called for on the Plans, do not splice bars without advance written approval from the BCE. Stagger approved splices when possible.

703.4.4.2 Lapped Splices

1. Provide lapped splices of the length shown on the Plans. If not shown on the Plans, provide the length of lapped splices in accordance with the *AASHTO LRFD Bridge Design Specifications* and approved by the BCE. In lapped splices, place and wire the bars to maintain the minimum distance to the surface of the concrete shown on the Plans.

703.4.4.3 Ultimate Welded Lap Splices

1. Use welded splices only if detailed on the Plans or with the written approval of the BCE. Make certain that the welds conform to the AWS D1.4, *Structural Welding Code - Reinforcing Steel*.
2. Make welded lap splices with low-hydrogen type electrodes. Before beginning the fabrication of the splices, submit for approval by the OMR the welding procedure and two test samples. Ensure that the Ultimate Welded Lap Splices under the static tension and compression test develop at least 100% of the specified ultimate tensile strength of the bar. Repair hot-dipped galvanized welded bars by use of a zinc rich formulation subject to approval of the OMR.

703.4.4.4 Ultimate Welded Butt Splices

1. Use Ultimate Welded Butt Splices only if detailed on the Plans or with the written approval of the BCE. Make certain that Ultimate Welded Butt Splices meet the requirements of **Subsection 703.2.5**.

703.4.4.5 Mechanical Couplers

1. Use Mechanical Couplers only if detailed on the Plans or with written approval of the BCE. Make certain that Mechanical Couplers meet the requirements of **Subsection 703.2.4**. Do not install any couplers until the passing strength test reports for that lot have been provided to the RCE.

703.5 Measurement

1. The quantity for Reinforcing Steel for Structures is the weight of reinforcing steel placed in a structure in accordance with the reinforcing steel schedule shown in the Plans unless otherwise directed and is measured by the pound (LB), complete, and accepted.

2. The weight of the bar supports is not included in the reinforcing steel quantity. Bar supports are considered incidental to the reinforcing steel work and all cost of furnishing and placing bar supports is included in the contract unit bid price for Reinforcing Steel for Structures.
3. The diameter, area, and theoretical weight of reinforcing bars are computed using Table 1 in ASTM A 706.
4. The weight of reinforcing wire, welded wire fabric, and plain bar of sizes other than those listed in Table 1 of ASTM A 706, is computed from tables of weight published by CRSI or computed using the nominal dimensions and an assumed unit weight of 490 pounds per cubic foot. The cross-sectional area of wire in square inches is assumed equal to its MW- or MD-Size Number. If the weight per square unit of welded wire fabric is given on the Plans, that is the weight used in the quantity for payment.
5. The weight of steel reinforcement in precast members is not measured when the cost of the reinforcement is included in the contract unit bid price for the precast member. Threaded bars or dowels placed in the work and used to secure such members to cast-in-place concrete after the installation of precast members is measured in the quantity for Reinforcing Steel for Structures.
6. No allowance is made for clips, wire, separators, wire chairs, and other material used in supporting, spacing, and fastening the reinforcement in-place or for galvanizing such items. If rebars are substituted at the Contractor's request and results in more steel than shown in the Plans, only the amount shown in the Plans is included in the measurement.
7. The additional steel for splices that are not shown on the Plans even though they are authorized as provided herein, is not measured. Mechanical couplers are not measured and are considered incidental to reinforcing steel item.
8. No allowance is made for the weight of galvanizing in computing the weight of reinforcing steel.

703.6 Payment

1. Payment for the accepted quantity of Reinforcing Steel for Structures, measured in accordance with **Subsection 703.5**, is determined using the contract unit bid price for the applicable item. Payment is full compensation for furnishing and placing reinforcing steel as specified or directed and includes fabricating, cutting, splicing, repairing or replacing, placing, and securing the reinforcing steel in structures and all other materials, labor, equipment, tools, supplies, transportation, and incidentals necessary to fulfill the requirements of the pay item in accordance with the Plans, the Specifications, and other terms of the Contract.
2. Payment for each item includes all direct and indirect costs and expenses necessary to complete the work.
3. Pay items under this section include the following:

| Item No. | Pay Item | Unit |
|----------|--|------|
| 7031100 | Reinforcing Steel for Structures (Roadway) | LB |
| 7031105 | Reinforcing Steel for Structures (Retaining Wall) | LB |
| 7031200 | Reinforcing Steel for Structures (Bridge) | LB |
| 7031210 | Spiral Reinforcing Steel for Structures (Bridge) | LB |
| 7031220 | Hoop Reinforcing Steel for Structures (Bridge) | LB |
| 7031400 | Galvanized Reinforcing Steel for Structures (Bridge) | LB |

ASTM STANDARD INCH-POUND REINFORCING BARS

| BAR SIZE DESIGNATION | NOMINAL DIMENSIONS | | |
|-------------------------|-----------------------------|-------------------|-------------------|
| | AREA (in. ²) | WEIGHT (lb/ft) | DIAMETER (in.) |
| #3 | 0.11 | 0.376 | 0.375 |
| #4 | 0.20 | 0.668 | 0.500 |
| #5 | 0.31 | 1.043 | 0.625 |
| #6 | 0.44 | 1.502 | 0.750 |
| #7 | 0.60 | 2.044 | 0.875 |
| #8 | 0.79 | 2.670 | 1.000 |
| #9 | 1.00 | 3.400 | 1.128 |
| #10 | 1.27 | 4.303 | 1.270 |
| #11 | 1.56 | 5.313 | 1.410 |
| #14 | 2.25 | 7.65 | 1.693 |
| #18 | 4.00 | 13.60 | 2.257 |

The current A615 specification covers bar sizes #14 and #18 in Grade 60, and bar sizes #11, #14 and #18 in Grade 75. The current A706 specification also covers bar sizes #14 and #18. Bar sizes #9 through #18 are not included in the A996 specification.

ASTM STANDARD METRIC REINFORCING BARS

| BAR SIZE DESIGNATION | NOMINAL DIMENSIONS | | |
|-------------------------|----------------------------|------------------|------------------|
| | AREA (mm ²) | WEIGHT (kg/m) | DIAMETER (mm) |
| #10 | 71 | 0.560 | 9.5 |
| #13 | 129 | 0.994 | 12.7 |
| #16 | 199 | 1.522 | 15.9 |
| #19 | 284 | 2.235 | 19.1 |
| #22 | 387 | 3.042 | 22.2 |
| #25 | 510 | 3.973 | 25.4 |
| #29 | 645 | 5.060 | 28.7 |
| #32 | 819 | 6.404 | 32.3 |
| #36 | 1006 | 7.907 | 35.8 |
| #43 | 1452 | 11.38 | 43.0 |
| #57 | 2581 | 20.24 | 57.3 |

The current A615M specification covers bar sizes #43 and #57 in Grade 420, and bar sizes #36, #43 and #57 in Grade 520. The current A706 specification also covers bar sizes #43 and #57. Bar sizes #29 through #57 are not included in the A996M specification.

Chapter 10

SCDOT Construction Manual

The following was taken directly from the SCDOT Construction Manual produced in May 2004 and an up-to-date version is expected soon. Check the SCDOT website at http://www.scdot.org/doing/construction_manual.aspx for the latest edition of these guidelines.

- **Section 101 (Abbreviated)**
- **Section 101: QC Sampling and Testing (Abbreviated)**
- **Section 701**
- **Section 702**
- **Section 703**

CONSTRUCTION MANUAL (Chapter 10)



RELATIONSHIP OF CHAPTER 10 TO CHAPTER 8 & 9

Labeled concurrently with Standard Specifications
of Chapter 8 & 9 (2007 Black Book).

| TOPIC | CHAPTER 10: CONSTRUCTION MANUAL | CHAPTER 8 & 9: STANDARD SPECIFICATIONS |
|---------------------------------|------------------------------------|---|
| Falsework & Forms | <u>702.2.6</u> | 702.2.12 |
| Rebar Supports | <u>703.2.5</u> | 703.2.6 |
| Sampling, Testing, and Labeling | Appendix B/C | Not Included |



CONSTRUCTION MANUAL

- This chapter provides construction guidelines to department and contractor personnel.
- It is written from the SCDOT Inspector's point of view.
- Chiefly concerns oversight:
 - Verify/Purpose of
 - Check/Inspect
 - Require/Measure
- These guidelines offer deeper insight into the standard specifications.



CONSTRUCTION MANUAL

- Only concerned with selected excerpts.
- 101 General Guidelines
- 701 Portland Cement and PCC
- 702 Concrete Structures
- 703 Reinforcing Steel



CONSTRUCTION MANUAL

Section 101 General Guidelines

- **101.1** Purpose & Organization of the Manual
- **101.2** Organization & Personnel Considerations
 - Management Offices
 - RCE & Inspector Duties
 - Safety
- **101.3** Project Development
- **101.4** Procurement & SCDOT Equipment
- **101.5** Documentation Considerations
- **101.6** Site Manager Considerations



CONSTRUCTION MANUAL

Section 701 Portland Cement and PCC

- **701.2** Pre-construction Considerations
 - Quality
 - Job Responsibility
 - Mix Materials
 - Plants and Hauling Equipment
 - PCC Mix Design



CONSTRUCTION MANUAL

Section 701 Portland Cement and PCC

- **701.3** Inspection During Construction
 - Batching & Mixing
 - Sampling & Testing including Frequency



SCDOT



UNIVERSITY OF
South Carolina

CONSTRUCTION MANUAL

Section 702 Concrete Structures

- **702.1** Description of Work
- **702.2** [More] Preconstruction Considerations
 - Planning and Checklists
 - Material Sources and Materials Types
 - Falsework and Forms

SCDOT

UNIVERSITY OF
South Carolina

CONSTRUCTION MANUAL

Section 702 Concrete Structures

- **702.3** Inspection during Construction
 - Placement
 - Vibration
 - Form Removal
 - Finishes



- **702.4 - .5** Post Construction Wrap-up



CONSTRUCTION MANUAL

Section 703 Reinforcing Steel

- **703.1** Description of Work
 - 703.1.2 Production of Iron and Steel Products on Federal Aid Projects**
On federal-aid projects, use only iron and steel products, including tie wire and supports for reinforcing steel and coatings, for which the manufacturing processes occurred in the United States in accordance with **Subsection 106.11**.
- **703.2** Materials
 - Covers: Deformed Rebar, Galvanized Materials, Mechanical Couplers, Bar Supports



Section 101

General Guidelines

101.1 PURPOSE AND ORGANIZATION OF THE *MANUAL*

The *SCDOT Construction Manual* has been prepared to provide the Resident Construction Engineer and SCDOT Inspectors with guidance in performing their day-to-day duties. The *Manual* is not a contractual document. The *Manual* is based on current SCDOT policies and procedures. Division 100 provides guidance on Contract administration from project start to closure; Divisions 200 through 800 provide inspection guidance for Contract pay items; Appendix A provides a descriptive table of SCDOT Construction Forms typically used by SCDOT construction personnel; Appendix B provides information on SCDOT Sample Identification Cards; Appendix C presents typical SCDOT Sampling and Testing Procedures; and Appendix D provides miscellaneous technical information that is typically used in construction. The *Manual* also includes a comprehensive Glossary and Subject Index of key acronyms, terms and definitions. SCDOT construction personnel are expected to become familiar with and employ the content of this *Manual* in conjunction with previous experience and sound engineering judgment. When situations are encountered that are not specifically addressed in this *Manual*, seek the advice of a supervisor.

101.2 SCDOT ORGANIZATION AND PERSONNEL CONSIDERATIONS

101.2.1 Central Office

101.2.1.1 Executive Level

With respect to construction, the executive level of the Department consists of the Executive Director, State Highway Engineer and Deputy State Highway Engineer. The Director of Construction and District Engineering Administrators report directly to the Deputy State Highway Engineer.

101.2.1.2 Program Manager

Most SCDOT construction projects will have a Program Manager from the Program Management Section who is directly responsible for the project until the Contract is closed. Generally, contracts include a 5% contingency. For changes that exceed the budgeted amount, contact the Program Manager.

101.2.1.3 Construction Operations

Figure 101A presents an organizational chart of SCDOT construction operations. The Director of Construction is directly responsible for the following SCDOT construction operations and reports directly to the Deputy State Highway Engineer:

1. Road Construction. The Road Construction Engineer in the Central Office is responsible for Statewide road construction projects that are not directly related to bridge structures. The Construction Applications Manager reports directly to the Road Construction Engineer and is responsible for the implementation and maintenance of construction support software, including BAMS/DSS, PES/LAS, Bid Express, Expedite and SiteManager. The Assistant Construction Engineers in the Central Office report directly to the Road Construction Engineer and provide support on road construction issues to District and field personnel and directly interface with FHWA Engineers on Federal-aid projects.
2. Bridge Construction. The Bridge Construction Engineer in the Central Office is responsible for Statewide construction of structures. The Assistant Construction Engineers in the Central Office report directly to the Bridge Construction Engineer, provide support on structural issues to District and field personnel, and directly interface with FHWA Engineers on Federal-aid projects.
3. Contract Administration. Contract Administration is responsible for administering contracts Statewide for SCDOT road and bridge construction projects through project closure.
4. Research and Materials Laboratory. The Research and Materials Engineer is responsible for establishing policies and procedures for approval of material sources and the sampling and testing of all materials used Statewide on SCDOT road and bridge projects.
5. Quality Management Team. The Quality Management Team is responsible for the review of construction management and engineering inspection duties performed on SCDOT projects. These reviews provide for adherence to and standardization of SCDOT requirements.

101.2.2 District Office

101.2.2.1 District Engineering Administrator

The State of South Carolina is divided into seven engineering Districts with a District Engineering Administrator in each District. All construction work within each District is the responsibility of the District Engineering Administrator. The District Engineering Administrator is responsible for ensuring that roads and bridges are constructed as specified in the Contract and for ensuring they are adequately maintained upon acceptance from contractors. The authority and responsibilities of the District Engineering Administrator are as delegated by the State Highway Engineer.

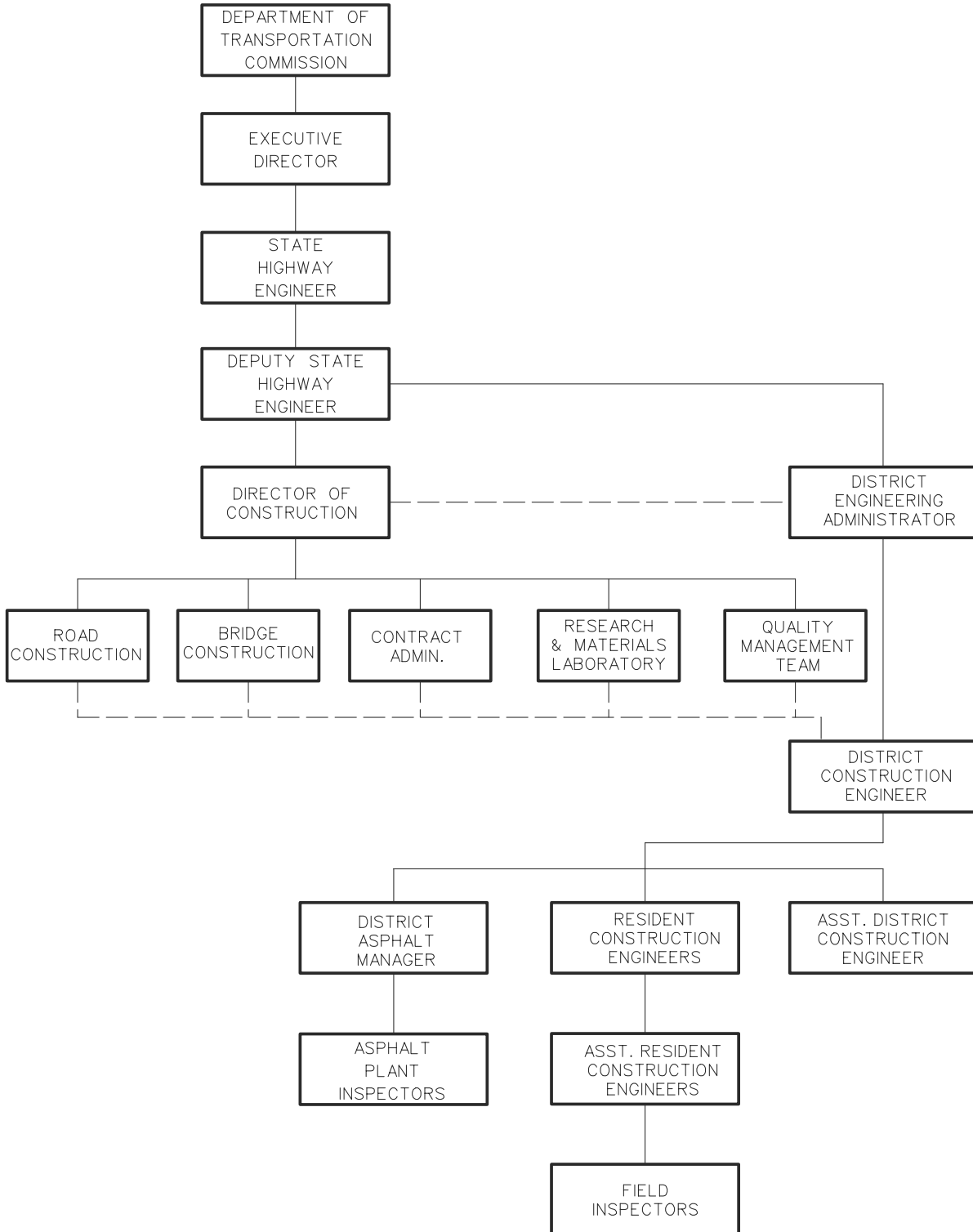

ORGANIZATION OF SCDOT CONSTRUCTION OPERATIONS
Figure 101A

101.2.2.2 District Construction Engineer

Each of the seven Districts within the State has at least one District Construction Engineer who reports directly to the District Engineering Administrator. The Assistant District Construction Engineer, if assigned, reports to the District Construction Engineer. The District Construction Engineer is responsible for the District Asphalt Manager and the Resident Construction Engineers within the District. Typical duties of the District Construction Engineer include:

- supervising the work of the Resident Construction Engineer;
- making regular visits to project sites to ensure that the work is being performed in accordance with the requirements of the Contract Plans and Specifications, including Special Provisions;
- ensuring that a sufficient number of samples and tests are being performed;
- ensuring that field and office records of the Resident Construction Engineer are being properly maintained;
- checking the status of As-Built Plans and ensuring they are being prepared on schedule;
- assisting with or making final construction inspections, as assigned by the District Engineering Administrator;
- ensuring that engineering equipment is being properly cared for;
- ensuring that good public relations are being carried out by SCDOT personnel; and
- other duties as assigned by the District Engineering Administrator.

101.2.2.3 District Asphalt Manager

The District Asphalt Manager reports to the District Construction Engineer, or assigned assistant. The District Asphalt Manager is responsible for the Asphalt Plant Inspectors. The District Asphalt Manager will be HMA Level 3 certified, as required by the Department. Typical duties of the District Asphalt Manager include:

- maintaining close contact with plant and roadway personnel;
- making notations of any problems found by the Contractor or SCDOT;
- resolving project problems as quickly as practical;
- checking all computations of roadway and plant reports and tickets;
- notifying the Contractor as soon as problems are noted;
- keeping the Resident Construction Engineer apprised of any problems and corrections;
- forwarding all paperwork to the Resident Construction Engineer for preparing estimates;
- processing check samples and immediately notifying the Contractor;
- maintaining daily records of all samples obtained and how they compared;
- ensuring pay factor sheets are complete and accurate; and
- other duties as assigned by the District Construction Engineer.

101.2.2.4 Asphalt Plant Inspector

The Asphalt Plant Inspector reports to the District Asphalt Manager. Asphalt Plant Inspectors are HMA Level 1 certified, as required by the Department. Typical duties of the Asphalt Plant Inspector include:

- visiting the plant site as needed;
- reviewing the Contractor's plant reports;
- monitoring all plant activities while on site;
- monitoring at least one entire test during the site visit;
- checking with the Contractor on any problems encountered;
- noting any deficiencies spotted by SCDOT personnel;
- obtaining bag samples for testing;
- verifying roadway cores and plant cores;
- checking the lime flow with Contractor;
- checking trucks and truck beds while on site;
- distributing reports as they are completed; and
- other duties as assigned by the District Asphalt Manager.

101.2.3 County Level

101.2.3.1 Resident Construction Engineer

Each District Office has jurisdiction over multiple counties within the State. At the project level, the Resident Construction Engineer has an office representing one or more counties within the District, depending on the size and construction activity in the area. Resident Construction Engineers are responsible for their office facilities and the construction projects assigned to them by the District Engineering Administrator. The Resident Construction Engineer is the SCDOT representative at the job site and reports to the District Construction Engineer. Depending on the level of construction activity, Assistant Resident Construction Engineers may be assigned. The typical duties of the Resident Construction Engineer include, but are not limited to:

- ensuring courteous and professional relations with local property owners and the public;
- ensuring that contractors and subcontractors are treated impartially by SCDOT personnel;
- having a thorough working knowledge of project requirements and the details of the Contract Plans and Specifications, including Special Provisions;
- assigning duties to SCDOT Inspectors and ensuring they understand how to carry out their assigned duties;
- ensuring SCDOT Inspectors are on duty at all required times and checking their activities for satisfactory performance (e.g., setting construction stakes, sampling and testing materials, inspecting items of work);

- regularly reviewing field notes and the Daily Work Reports of SCDOT Inspectors to ensure that adequate records are being maintained as the work progresses;
- maintaining complete and accurate contractual records of project activities and ensuring that all required written reports are promptly and properly furnished;
- maintaining contractual records in such condition that they may clearly and easily be followed by personnel unfamiliar with the project;
- monitoring the project schedule and supervising the timely preparation of As-Built Plans;
- ensuring compliance of material, equipment and work, regularly spot checking all phases of the work on the project;
- assessing the work on pay items for acceptance and directly interfacing with the Contractor Superintendent to resolve any problems encountered;
- ensuring the timely computation of pay item quantities upon acceptance of the work, approving the Daily Work Reports and preparing the Monthly Pay Estimate; and
- other duties as assigned by the District Construction Engineer.

The Resident Construction Engineer prepares Monthly Pay Estimates for each pay item as the work progresses. The Contractor is required to sign off on these Estimates for payment. If the Contract Plans are changed during construction, they are modified and prepared as As-Built Plans. By using this method of administration, the Resident Construction Engineer will not be required to compute final pay quantities at project completion, but must submit with the As-Built Plans the required final project documentation (e.g., Asphalt Recap Sheets, Pile Data Sheets). See Section 110.2 for additional information on As-Built Plans and required documentation.

101.2.3.2 SCDOT Inspector

SCDOT Inspectors report to the Resident Construction Engineer and are directly involved in the construction of road and bridge projects. SCDOT Inspectors include engineering technicians, surveyors, plant inspectors, roadway inspectors and bridge inspectors. Typical duties of SCDOT Inspectors include, but are not limited to:

- monitoring erosion control;
- monitoring Contractor activities on road and bridge construction projects;
- monitoring traffic control for adherence to requirements;
- monitoring the Contractor's checks for material application rate and yield;
- monitoring the Contractor's reports for accuracy;
- monitoring placement of material, as directed by Resident Construction Engineer;
- maintaining Daily Work Reports of Contractor activities;
- noting any deficiencies found by Contractor or SCDOT personnel;
- performing required sampling and testing of work and materials;
- accepting or rejecting materials, equipment and work;

- recording accepted pay item quantities in the Daily Work Report; and
- other duties as assigned by the Resident Construction Engineer.

101.2.4 Personnel Policy

101.2.4.1 Rules and Regulations

SCDOT employees are governed by the Department's Personnel Rules and Regulations, which are furnished to all supervisors. Meetings will be held periodically by supervisors to familiarize SCDOT employees with current Department policy. Policy changes and updates will be disseminated to employees by memorandum through their supervisor. Any questions regarding personnel policy should be directed through the proper channels.

101.2.4.2 Integrity

Absolute integrity on the part of SCDOT personnel is essential, if public confidence is to be maintained. Excessive fraternization between SCDOT employees and Contractor personnel is discouraged. Refer to the publication *Guide to the South Carolina State Ethics Act* for additional information.

101.2.4.3 Training and Certification

SCDOT requires formal training and certification to ensure that personnel are properly qualified to perform their respective duties. The Technician Certification Program is generally based on input from representatives from SCDOT, FHWA and the industry. SCDOT typically has a third party, such as a State University, administer the coursework and examinations, for which a Certification of Qualification will be issued upon successful completion. On-the-job trainees will be trained under the direct supervision of a certified technician. Because certification demonstrates competency with procedures unique to South Carolina, reciprocity with other agencies is generally not permitted. See the Department's Technician Certification policy on the SCDOT Intranet Website for additional information.

101.2.4.4 Intra-Department Cooperation

Good relationships with fellow employees and with other departments within SCDOT are of vital concern. All SCDOT employees should be working in a professional manner toward a common goal. An understanding and appreciation of the functions of other SCDOT departments is a valuable asset. Written or verbal instructions are given regularly to the Resident Construction Engineer, and this information should be transmitted to other SCDOT personnel in a timely manner. A bulletin board in each office is suggested. The Resident Construction Engineer should keep the District Construction Engineer informed of any unusual condition or circumstances that may arise. This can be performed by letter, facsimile, e-mail, telephone or during visits to the project site.

101.2.4.5 Public Relations

SCDOT construction personnel are under the critical public eye, such as adjacent property owners, local residents and passing motorists. It is essential that all SCDOT employees conduct themselves in a manner that will command the respect and confidence of the public. The public will ask SCDOT representatives many questions during the construction of a project. All questions should be answered as accurately and as courteously as possible. Questions that cannot be answered should be referred to a supervisor, or to other sections of the Department, if necessary. Adjacent property owners are always concerned with the construction work to be performed within the limits of their property. A problem that may seem minor to an SCDOT employee may be of grave concern to the property owner. Any issues should be addressed promptly and courteously with the property owner involved. See Section 101.7.3 for information on SCDOT's policy concerning the media.

101.2.5 Safety

101.2.5.1 General

Accidents are not only costly to the employee and the Department, but result in pain, disability and possibly death. Employees should be safety conscious at all times, both as to proper driving and safe working conditions. One should be aware of the potential hazards in each duty performed and take every precaution to prevent injuries. Resident Construction Engineers should have monthly meetings with all employees under their supervision to discuss safe driving and working conditions. At these meetings, it is advisable to discuss any accidents that may have occurred to determine their cause and what steps could have been taken to prevent these accidents.

101.2.5.2 Safe Driving

Employees should realize that, because they are employed by the State and driving State-owned vehicles, the public is observing their driving practices and is prone to criticize employees of the Department for all violations whether they are minor in nature or serious. All employees are, therefore, urged to set a good example for the traveling public. Employees should know and observe all laws.

101.2.5.3 Surveying

When a survey party is working on a heavily traveled highway, it is necessary to have signs or flaggers to direct traffic. If signs are in place, they should be the proper distance ahead of the survey party so as to warn traffic of its presence on the highway. If placed too far in advance of a survey party, signs lose their effectiveness. When flaggers are used, they should wear the proper colored clothing, be furnished with proper flagging equipment, and be given instructions on the proper method of directing traffic. Part 6 of the *MUTCD* addresses proper flagging attire and techniques. When using such tools as axes, hammers or bush axes, adequate space should be maintained between personnel so that there will be no danger of being struck by these tools. When cutting overhead, care must be taken to prevent limbs or other foreign matter

from causing injury. All employees should be alert for snakes and insects, particularly in areas where there is heavy growth. When working near power lines, extreme care should be exercised so as not to come in contact with electrical wires. Remember that chains and metallic tapes are conductors of electricity and should never be allowed to touch electrical wires.

101.2.5.4 Medical Treatment

In case of injury, seek medical treatment promptly. A minor injury may become infected if medical treatment is not provided and may result in painful and costly injuries. First-aid kits are available from the Supply Depot. These should be obtained and kept in a convenient location for use if and when needed. Resident Construction Engineers should be familiar with necessary forms to be submitted in the event of injuries and ensure that these reports are submitted promptly with all necessary information furnished. Complete and process OSHA Form 300, SCDOT Form 12A, SCDOT Form 12B and SCDOT Form 576, as appropriate, for personnel injuries and motor vehicle accidents.

101.2.5.5 Safety Equipment

Personal protective equipment (e.g., hard hats, vests, boots) will be made available to all SCDOT personnel. SCDOT personnel will wear only hard hats and safety vests bearing the SCDOT seal. Contractor personnel must not wear SCDOT hats or vests. Consult the *Employee Safety Manual* for current policies.

101.2.5.6 Nuclear Density Gauges

101.2.5.6.1 General Guidelines

Nuclear density gauges are used by certified technicians to test the density of materials on the project. Adhere to the following guidelines:

- Do not operate a nuclear density gauge unless you are certified and authorized to do so.
- Keep unauthorized personnel away from the nuclear density gauge.
- Follow the established operating procedures when using the nuclear density gauge.
- Maintain the nuclear density gauge in the "SAFE" position when stored or not in use.
- Ensure that the nuclear density gauge is properly secured when stored or not in use.
- Ensure that the nuclear density gauge is stored in an approved location.

Contact the Research and Materials Laboratory Radiation Protection Officer for any needed assistance. See the *SCDOT Guide Instruction Manual for Inspectors of Earthwork and Base Course Construction* for additional information on nuclear density gauges.

101.2.5.6.2 Certification and Licensing Considerations

Only certified technicians are permitted to operate and transport nuclear density gauges. The use and transport of nuclear density gauges also require licensing by SCDHEC, because misuse or mishandling of these devices can pose hazards to personnel and the environment.

101.2.5.6.3 Transporting and Storage Considerations

In preparing the nuclear density gauge for transport or storage, or if it is necessary to leave the gauge unattended for any length of time, lock the source rod in the "SAFE" position, place the gauge in its transport case and lock the case. When not in use, the nuclear density gauge must be stored behind two locked doors. The lock on the transport case does not count as one of these locks. The storage area cannot be in a regularly occupied work area. All storage areas must be approved by the Central Laboratory Radiation Protection Officer and must be posted with the proper signage and notices. When transporting the nuclear density gauge, it must be placed in the rear area of an SUV or vehicle (e.g., trunk). The folder containing the Bill of Lading and the SCDHEC Radioactive Material License must be kept with the nuclear density gauge at all times. Each day the gauge is used, complete SCDOT Form 100.08 – Monthly Report of Testing Activities with Nuclear Gauge. At the end of each month, forward a copy of Form 100.08 to the Research and Materials Laboratory Engineer, which is due no later than the 15th of the month. Carefully adhere to these reporting requirements. Non-compliance will result in penalties imposed by SCDHEC.

101.2.5.6.4 Emergency Procedures

If a nuclear density gauge is involved in a vehicular crash, is lost or stolen, gets crushed by heavy equipment, is dropped from a moving vehicle or is damaged in another mishap that could damage or break the source rod:

- stop any vehicle that may have collided with the gauge and which could possibly have radiation contamination on tires, cleats or tracks;
- do not move the gauge or any of its parts;
- use rope or colored survey marking tape to cordon off the area for a distance of 20 feet from the gauge and any of its scattered parts;
- post SCDOT personnel outside the cordoned area to prevent others from walking through the site; and
- immediately notify the Research and Materials Laboratory personnel by calling the numbers listed on the Emergency Telephone List for Central Laboratory Personnel. They will then decide if it is necessary to call the Department of Health and Environmental Control Emergency Radiological Assistance.

For other non-emergency incidents (e.g., source rod being jammed in an unshielded position, source rod coming out of gauge, malfunction of the gauge), contact the Research and Materials Laboratory for assistance.

101.3 PROJECT DEVELOPMENT CONSIDERATIONS

101.3.1 Constructability Review

101.3.1.1 Purpose of the Review

Prior to construction, SCDOT construction personnel will participate in a Constructability Review for the following types of projects:

- Interstate and interchange reconstruction or widening projects;
- non-Interstate projects with an estimated construction cost over \$25 million;
- projects that are considered sensitive, innovative or have multi-stage construction; and
- other projects, as directed by the Program Manager.

During the meeting, the Constructability Review Team will discuss key issues related to the construction of the project, including:

- traffic staging requirements and impacts on construction activities;
- materials availability and procurement time;
- availability of on- and off-site storage and staging areas;
- equipment access and the need for additional access;
- types of waste that may be encountered and availability of disposal areas;
- utility conflicts and the potential for project delays; and
- geotechnical issues and environmental obligations.

The objective of the Constructability Review is to ensure:

- the project, as detailed in the Contract Plans and Specifications, can be constructed using standard construction methods, materials and techniques;
- the Contract Plans and Specifications will provide the Contractor with clear and concise information that can be utilized to prepare a competitive, cost-effective bid; and
- the project, when constructed in accordance with the Contract Plans and Specifications, will result in a project that can be maintained in a cost-effective manner by SCDOT over the life of the project.

101.3.1.2 Constructability Review Team

The Constructability Review Team will consist of the Program Manager, Designer, personnel from the Director of Construction's Office, the appropriate District Construction Office, the FHWA, and one or more contracting firms representing the construction industry.

101.3.1.3 Selection of Contracting Firms Representing the Industry

The Director of Construction will be responsible for contacting and selecting one or more contracting firms representing the construction industry to participate in the Constructability Review. Invitations are distributed annually and selection for involvement is generally performed on a rotational basis.

101.3.1.4 Meeting Coordination and Scheduling

The Constructability Review will be held at the project site and should only require one full day of participation. The meeting will be scheduled after the Design Field Review but before the final Right-of-Way Plans are completed. The Program Manager will be responsible for coordinating and scheduling the meeting. A representative of the Director of Construction's Office will facilitate the meeting.

101.3.1.5 Constructability Review Report

The Constructability Review Report will be forwarded to the Road, or Bridge, Construction Engineer responsible for the project and will include the final recommendations of the Constructability Review Team. The Resident Construction Engineer and Inspectors assigned to the project should carefully review the Report prior to the Preconstruction Conference.

101.4 PROCUREMENT AND USE OF SCDOT EQUIPMENT

101.4.1 Motor Vehicles

101.4.1.1 General

Motor vehicles are assigned to the Resident Construction Engineer, as deemed necessary by the District Engineering Administrator, and may be transferred from one Resident Construction Engineer to another. The Resident Construction Engineer is responsible for assigning a responsible driver to the vehicle. Although other SCDOT personnel may drive the vehicle, the responsible driver will ensure the proper service, maintenance and care of the vehicle. Service and repair work may be obtained at any SCDOT Maintenance Shop or at the SCDOT Equipment Depot in Columbia, South Carolina. However, the Maintenance Shop in the county in which the vehicle is principally used usually performs such work.

101.4.1.2 Care of Motor Vehicles

There is wide variation in manufacturers' recommendations for periodic servicing of automotive vehicles. The frequency of servicing should be controlled by the conditions under which the vehicle is operated. For this reason, periodic servicing and a preventive maintenance program will be carried out as prescribed by the District Engineering Administrator or the Director of Supply and Equipment. In the absence of such a prescribed program, the manufacturer's recommendations are to be followed. The Resident Construction Engineer and the responsible driver assigned to the vehicle will ensure that the vehicle is kept clean and properly serviced,

arranging with the Maintenance Shop for such service work to be performed. Remember that the Maintenance Shop will not always be able to service equipment upon request due to other scheduled work; however, a satisfactory appointment can usually be arranged.

101.4.1.3 Use of Motor Vehicles

Motor vehicles assigned to Resident Construction Engineers are intended for official use only and may not be operated for personal use. Vehicles will usually be parked at the Resident Construction Engineer's office or at the Maintenance Shop at night. In some cases, however, where it is considered most advantageous to the Department, employees may, at the recommendation of the District Engineering Administrator and by approval of the Executive Director, be permitted to drive vehicles home at night. When this is permitted, the driver of the vehicle will be expected to take reasonable precautions to protect the vehicle from damage and vandalism. The driver of any motor vehicle is expected to care for it as though it were personal property. Negligent operation or willful abuse may result in penalizing the driver for all or part of any loss sustained. A vehicle trip log should be maintained for each vehicle.

101.4.2 Equipment and Supplies

101.4.2.1 Acquisition of Equipment and Supplies

Requests for acquisition of SCDOT supplies and equipment should follow the most current procurement procedures.

101.4.2.2 Expendable and Non-Expendable Equipment

All equipment owned by SCDOT is categorized as either expendable or non-expendable. In general, expendable equipment is confined to low-cost units that have rather limited service lives. Where any appreciable capital investment is involved, equipment is classified as non-expendable and will be securely controlled to impose strict custodial accountability on employees to whom the equipment is assigned. When non-expendable equipment is purchased, the Supply and Equipment Division will assign an SCDOT property number to the equipment, and a Property Receipt (Form 557) will be prepared. After being signed by the custodian of the property, copies of the Property Receipt will be properly distributed. Once accountability has been assigned to the custodian, responsibility for the equipment can be relieved by properly executing either a Property Transfer (Form 524) or a Property Disposal Authorization (Form 529). See Section 101.4.2.4 for additional information on disposal of equipment. Equipment custodians will be held fully accountable for the proper use and care of the equipment assigned to them. See Section 101.4.1 for information on motor vehicles.

101.4.2.3 Equipment Inventory

Annually, on June 30th, a complete field inventory will be made of all SCDOT non-expendable equipment. Equipment custodians will receive a list from the Director of Finance for checking

and certifying all non-expendable equipment assigned to them. Expendable equipment will be reported on Form 3055B at the same time. Equipment custodians must maintain accurate records of equipment, especially copies of Property Receipts (Form 557), Property Transfers (Form 524) and Property Disposal Authorizations (Form 529) for non-expendable equipment.

101.4.2.4 Disposal of Equipment

Non-expendable equipment may be disposed of by junking or salvaging useable parts, by trading in when purchasing new equipment or by selling outright in an advertised sale. Disposal of the equipment must be processed using a Property Disposal Authorization (Form 529), which will be prepared by the Director of Supply and Equipment and approved by the Executive Director. To initiate the process, the custodian will prepare a Request to Dispose of Accountable Property (Form 3024) for review and approval. As a rule, most equipment assigned to Resident Construction Engineers will be turned in to either the Equipment Depot or to the Office Supply Room for disposal. Under such circumstances, the Custodian is relieved of accountability through the execution of a Property Transfer (Form 524).

101.5 DOCUMENTATION CONSIDERATIONS

101.5.1 Purpose

To ensure compliance before payment is made to the Contractor, the Resident Construction Engineer and the SCDOT Inspectors are responsible for documenting the day-to-day accounts of the work in progress. The information collected and documented serves two purposes:

- to assess contractual compliance with respect to legal issues, scope of work, control of materials and project schedule; and
- to determine the quantity to pay the Contractor for progress on the pay item.

Although both types of information are necessary, they serve different purposes. For example, an SCDOT Inspector could measure and document a quantity for payment; but without the required test results, SCDOT has no way of knowing if the work and materials for the pay item warrant payment in terms of acceptability. In other words, the test results could have conceivably shown that the work and materials measured warranted rejection, not acceptance and payment. Such project records must be accurate and detailed, because they are the only means by which SCDOT can ensure that a project has been constructed as specified. In addition, these project records are critical for project closure and may become important evidence in assigning responsibility for project incidents and determining time, money and liability if a claim is filed.

101.5.2 SiteManager and SCDOT Construction Forms

SCDOT uses SiteManager for Contract administration. SiteManager is an AASHTO computer application that is used to administer construction contracts and facilitates the gathering and maintenance of critical contract records. SCDOT Inspectors are primarily responsible for processing the Daily Work Reports, and Resident Construction Engineers are responsible for

processing and approving the Daily Work Reports and Monthly Pay Estimates. SiteManager will maintain a running track of quantities paid and pending, and payment may be initiated once the Resident Construction Engineer approves the Daily Work Reports and generates the Monthly Pay Estimate. In addition, various types of construction forms are required by the Department to supplement the information that is entered into SiteManager. Become familiar with the SCDOT Construction Forms that are required for Contract administration, inspection and sampling and testing and make certain they are legible and thoroughly and accurately prepared. Also consider the benefits of gathering data using digital and video cameras. Such information will be especially useful if a claim or litigation is anticipated. Unless otherwise directed, hard-copy documents will be retained by the Resident Construction Engineer and referenced, as appropriate, in the Daily Work Report. See Section 101.6 for additional information on the use of SiteManager. See Appendix A for a descriptive table of the SCDOT Construction Forms typically used by SCDOT construction personnel.

101.5.3 Documentation for Payment

In general, the Resident Construction Engineer and SCDOT Inspectors must review the Contract and clearly understand, for each pay item:

- key points of inspection;
- acceptance criteria;
- applicable deductions for non-compliance;
- criteria for rejection;
- unit of measurement used to determine the quantity for payment;
- measurements that need to be obtained to calculate the quantity;
- location where the measurements need to be obtained (i.e., field or plans);
- work and materials that should not be measured separately for payment;
- calculations required for determining progress payments; and
- supplemental documents required (i.e., delivery tickets, invoices).

Improper payment documentation may cause administrative delays and difficulties with Contractors. The importance of clearly understanding the method of measurement and basis of payment for each pay item in the Contract cannot be overemphasized. Notwithstanding the responsibilities of SCDOT personnel, this information must be clearly communicated to the Contractor at the Preconstruction Conference. Most Contract pay items will be defined in the *Standard Specifications*; however, as SCDOT policy and methods change, Contract documents may contain overriding criteria in the Supplemental Specifications and Special Provisions.

101.6 SITEMANAGER CONSIDERATIONS

101.6.1 Daily Work Reports

101.6.1.1 General

The Daily Work Reports should begin on the date of the Notice to Proceed. A Daily Work Report should be completed for each day of the project, from the Notice to Proceed until the

charging of time is stopped. If additional work is performed on the project (e.g., corrective work, punch list items, etc.), a Daily Work Report also should be completed for each day that such work is performed.

101.6.1.2 Information Tab

Use the following guidelines to complete the information under the Information Tab:

1. General DWR Information. Displays specific information for the Daily Work Report, including Contract ID, Inspector name and date.
2. Locked. This field indicates that the current monthly estimate has been approved. A locked Daily Work Report can not be edited.
3. Authorized. This field indicates whether or not the Daily Work Report has been authorized by the Resident Construction Engineer. The date of authorization will be displayed. An authorized Daily Work Report can not be edited.
4. Weather Conditions. Enter the weather conditions for the day.
5. No Work Items Installed / No Contractors on Site / No Daily Staff on Site. This will indicate whether or not there is information under any of the subject tabs. Note: This checkbox is not always accurate. If a user adds an item and then deletes it, the checkbox will remain empty. Please double-check these boxes to confirm that they are correct.
6. Work Suspended. This feature suspends time charged to the Contractor. Do not use this feature.
7. Remarks. As needed, enter remarks in text box on the right after selecting the appropriate category.

101.6.1.3 Contractor Tab

Use the following guidelines to complete the information under the Contractor Tab:

1. General DWR Information. Displays specific information for the Daily Work Report, including Contract ID, Inspector name and date.
2. Contractor. Use this function to indicate the contractors that are present on the job site. Additional contractors can be added by clicking the New button. Contractors must be included in this window in order to credit their installation of items under the Work Item Tab. All contractors that are present on the jobsite for that given day are to be selected.
3. Supervisor / Foreman Name. Use this location to select the supervisors that were present on the job site. Additional supervisors can be added by clicking the New button.

4. Personnel Type. Use this location to select the personnel types present on the job site. Additional personnel types can be added by clicking the New button.

101.6.1.4 Contractor Equipment Tab

Use the following guidelines to complete the information under the Contractor Equipment Tab:

1. General DWR Information. Displays specific information for the Daily Work Report, including Contract ID, Inspector name and date.
2. Contractor. Use this location to select the contractors that were present on the job site.
3. Equipment ID / Description. Use this location to select the equipment on the job site. Additional equipment can be added by clicking the New button.

101.6.1.5 Daily Staff Tab

Use the following guidelines to complete the information under the Daily Staff Tab:

1. General DWR Information. Displays specific information for the Daily Work Report, including Contract ID, Inspector name and date.
2. Staff. All SCDOT personnel present on the job site are to be entered. New staff members can be added by clicking the New button. Any visitors such as FHWA, consultants, etc. can be entered in the Remarks box.
3. S / C. Use this location to identify the employee as a staff member or consultant.
4. Staff Information. Use this function to input Inspector's hours.

101.6.1.6 Work Items Tab

Use the following guidelines to complete the information under the Work Items Tab:

1. General DWR Information. Displays specific information for the Daily Work Report, including Contract ID, Inspector name and date.
2. General Item Description. Displays the project number, line item number, item code, description, unit price, status and unit type of the present item. This information is loaded into the system with the basic Contract data after award or is entered via a Change Order.
3. Quantity Installed to Date / Quantity Paid to Date. Both of these fields display the quantity of the present item that has been approved and included on an Estimate. The quantity displayed will only apply to the particular project number listed above, not the total Contract quantity for this item.

4. Bid Quantity. This field displays the original Contract quantity.
5. Current Contract Quantity. This field displays the original Contract quantity in addition to any quantity added to the Contract via an approved Change Order.
6. Pay to Plan Quantity. This field primarily applies to lump sum items. Items identified as Pay to Plan Quantity will not allow the system to pay for any quantity in excess of the bid quantity.
7. Location List. This field allows users to enter multiple locations for the same item on one screen. A new location can be entered by clicking on New from this zone and entering the new information.
8. Placed Quantity. Use this field to enter the quantity placed in a particular location.
9. Contractor. This is a drop-down list displaying all contractors who have been approved to install this item and have been added to the Contractor Tab.
10. Plan Page Number. Use this field if referring to a particular page in the plan sheet.
11. Reference Document. Use this field if attaching a reference document.
12. Location. Each individual location installed should be entered in this field.
13. Measured Indicator. Use this field if the installation of this item quantity was measured.
14. Station Numbers. Use this field to enter station numbers, "from" and "to", offset (i.e., "lt" or "rt" for left or right) and distances. Information pertaining to stations, offsets and distances are required for all applicable items. All roadway items should be referenced to station numbers and bridge items may be referenced to bent numbers.

101.6.2 Diaries

101.6.2.1 Approval of Daily Work Reports

The Resident Construction Engineer will use the Diary window to review and approve the Daily Work Reports submitted by SCDOT Inspectors. Once reviewed and approved, the Resident Construction Engineer will check the Approve box on the Diary window. All quantities approved by the Resident Construction Engineer will be included in the next Estimate, provided that the date of the Daily Work Report date is no later than the period end date of the Estimate. A Daily Work Report cannot be edited once approved. If the Daily Work Report has already been approved and editing is necessary, consult the Resident Construction Engineer. Daily Work Reports are irrevocably locked once the estimate they are included in is approved.

101.6.2.2 Charging Contract Time

Each time a Diary is created by entering a date and saving the Diary, a day is charged to the Contractor. A Daily Work Report does not have to be approved for a day to be charged. If a Diary has been created, but a day should not be charged (e.g., before Notice to Proceed date,

waiting on punch-list items), the Resident Construction Engineer should click on the Charge Tab on the Diary window and make that day a No Charge day. Diaries must be completed for each charged day beginning with the Notice to Proceed and continuing through the Substantial Work Complete Date at a minimum.

101.6.2.3 Changing the Status of Existing Diaries

When a Diary is created, a day is automatically charged to the Contractor. Once an estimate is generated and approved, a Diary cannot be altered from the Diary window. However, the Resident Construction Engineer can change the status of a Diary to a Charge or No Charge day by using the Diary Adjustments window. To adjust a Diary, the user must first open the Diary Adjustments window and open the Contract and the day to be adjusted via the Open button. Once the individual Diary has been opened, the user can enter the new status and reason code and reason (e.g., prior to Notice to Proceed date, waiting on punch-list items). This window is often used to correct a day charged to the Contractor that should not have been charged.

101.6.3 Change Orders

101.6.3.1 Explanations and Reason Codes

SCDOT personnel who create a Change Order in SiteManager for a Supplemental Agreement or Contract Modification Request must provide an explanation and Reason Code that accurately describes why the Change Order is necessary. This information is critical, because Contract Administration analyzes this data for recurring changes to improve SCDOT's planning process, thus avoiding such changes in the future. Prior to the use of SiteManager, it was not unusual to prepare a single Change Order for the purpose of adding multiple items of work for a variety of reasons. This practice must not be used when creating Change Orders in SiteManager, because it causes administrative delays and defeats the purpose of using the integrated database.

The Reason Code selected for the Change Order must correspond to the explanation and accurately apply to the items of work listed on the Change Order. Before creating a Change Order in SiteManager, review and organize each subject item of work under an appropriate Reason Code. Create one Change Order for each Reason Code identified, listing only those items of work that apply to the Reason Code selected. A full set of Reason Codes is available in SiteManager. Contact Contract Administration with any suggested improvements or additions. Consider the following Reason Codes when creating Change Orders in SiteManager:

1. Claims Settlement. This Reason Code is mostly self-explanatory. If the Contractor pursued a claim on the Contract and the Department completed a Change Order to pay the claim, use this Reason Code, which is applicable if the Department settled the claim internally, if the claim went to a dispute review board or if the claim was concluded through litigation.
2. Contract Time Adjustment. This Reason Code may need to be broken up into more refined categories, because there are a number of reasons that Contract time

adjustments may be justified (e.g., utility delays, utility accommodations, changes to traffic control, allowable work hours, allowable lane closures, additional work or quantities). The use of this Reason Code assumes that a time adjustment is the only function of the Change Order, which is not the typical case. Until Contract Administration and the SiteManager Administrator can effectively refine this Reason Code, ensure that the explanation provides the appropriate details.

3. Cost Savings Proposal/Suggestion. This Reason code pertains to Change Orders initiated as a result of a Value Engineering Proposal submitted by the Contractor.
4. Decreasing/Increasing Quantities. Use this Reason Code when actual and bid quantities for items of work in the original Contract vary to the extent that it is reasonable to adjust the Contract quantities. Overrun and underrun items are included to offset each other to avoid increasing the original Contract amount.
5. Deleting/Adding Items. Use this Reason Code when it is necessary to delete or add completed items of work and their respective quantities. Such items are usually incidental in nature. This Reason Code should not be used when the basis is a significant change to construction or an error in the Contract Plans and Specifications.
6. Design Oversights. This Reason Code should only be used when an error or oversight in the Contract Plans and Specifications has been discovered that could have been foreseen during the design phase. Do not use this Reason Code for changes that arise from field conditions or conflicts that could not have been reasonably anticipated during design. It is anticipated that this category will be further refined. Contact the SiteManager Administrator for additional information.
7. Extension. Use this Reason Code only when the items and quantities are required because of an approved extension request. An extension request must be processed through the proper SCDOT channels and approved by the State Highway Engineer. The Change Order will establish the extension work for administration in SiteManager and will become a supporting document to the approved extension request.
8. Final Quantity Adjustment. This Reason Code should be used only when an audit of the reported quantities or Contractor concurrence of final quantities requires adjustment.
9. Force Account. Work performed on a Force Account Basis will ultimately need to be resolved by negotiating unit prices with the Contractor for the items under dispute. The negotiations must be supported by cost data collected during the actual prosecution of the disputed work. As such, this Reason Code and the Force Account function under the Change Order header in SiteManager must be used to establish, track and resolve the items, quantities and unit prices for the disputed work.
10. Incentive/Disincentive Payment. Use this Reason Code to create a Change Order only when it is necessary to establish an authorized incentive/disincentive payment schedule that is not in the original Contract. Otherwise, use SiteManager's Contract Adjustment or Line Item Adjustment functions for incentive/disincentive payments.
11. Modification by Construction Personnel. This Reason Code should be used when construction personnel encounter field conditions that necessitate changes to the work

or when the District prefers changes to the original design. If the change is due to a condition that could have been reasonably foreseen during the design phase, use the Design Oversights Reason Code.

12. Plan Revision. Use this Reason Code when the Change Order is required to accommodate changes to the work that are shown in a revision to the Contract Plans that has been issued by the Director of Construction. Note, however, if the revision has been issued due to a field modification or design oversight, other Reason Codes will apply (e.g., Design Oversights). Ensure that the proper one is used. Plan Revision applies to changes to typical sections and right-of-way areas that arise from late right-of-way settlements or from public or political requests to revise the original design.
13. Price Adjustment. If conditions are encountered that significantly affect the scope or the work and a price adjustment is warranted, use this Reason Code. This Code generally will apply when major items of work (see Section 101.33 of the *Standard Specifications*) are affected; however, other items may be considered as well. Do not use this Reason Code for price adjustments related to Fuel or Asphalt Price Indices, which will already be authorized in the original Contract provisions. Rather, use SiteManager's Contract Adjustment or Line Item Adjustment functions to adjust payment.
14. Traffic Control Modification. When traffic situations encountered during construction require a change to the Traffic Control Plans and the change results in revised costs to the Contractor, this Reason Code should be used.
15. Other. This Reason Code should be used sparingly and only when the basis for the change cannot be categorized with previously established Reason Codes. When used, however, ensure that the explanation provides adequate detail of the basis for the change. Contract Administration will coordinate with the SiteManager Administrator to create an additional Reason Code, if warranted.

101.6.3.2 Item Quantity and Price

Change Order functions are located on the Change Order Header window. If the quantity of an existing item is being changed, the Overrun/Underrun box should be checked. If the price of an existing item is being changed, or a new item is added, the Extra Work box should be checked.

101.6.3.3 Classification and Approval

Contract changes are classified as either minor or major. Minor changes are those which revise the total Contract amount by no more than \$50,000, enforce penalties (e.g., price reductions) in accordance with the Contract Specifications or revise Contract time due to the scope or difficulty of the additional work. All other Contract changes will be classified as major, including Contract time extensions due to weather and utilities. The administration of Federal-aid projects will be based on the FHWA/SCDOT Agreement. Change orders on all Federal oversight projects must be approved by the FHWA (see Figure 107A).

A Change Order under \$25,000 with no time adjustment can be processed and approved by the Resident Construction Engineer. If the amount of the Change Order is between \$25,000 and \$50,000, with or without a time adjustment due to an increase in the scope of work, the District Engineering Administrator must approve the Change Order. All other Change Orders will be considered major (e.g., over \$50,000 or with time adjustments due to utility delays, weather, etc.) and must be approved by the Director of Construction. If a Change Order is deemed major, the Resident Construction Engineer will be required to click the check box for Override Approval Rules and manually establish the approval chain as follows:

- Resident Construction Engineer,
- District Construction Engineer,
- District Engineering Administrator,
- Assistant Construction Engineer,
- State Road or Bridge Construction Engineer,
- Director of Construction, and
- FHWA, for Federal oversight projects.

101.6.3.4 Contract Extension Approval

Additional projects will be added to the Contract only after approval by the State Highway Engineer. Once approved, the Assistant Construction Engineer in Columbia will create the project in SiteManager. It will then be the responsibility of the Resident Construction Engineer to create a Change Order adding the items of the project to the Contract. Once items are included in the Change Order contact the Assistant Construction Engineer to establish the funding for the work. See Section 104.4 for additional information.

101.6.3.5 Contractor Concurrence

Once the prices on a Change Order have been agreed upon by the Resident Construction Engineer and the Contractor, the Resident Construction Engineer should create a listing of the prices, quantities, explanations, Reason Codes, etc., and the listing should be signed by the Resident Construction Engineer and the Contractor.

101.6.4 Estimates

101.6.4.1 Generating Estimates

Estimates can only be generated by the first level of approval (i.e., Resident Construction Engineer). Prior to generating an Estimate, the Resident Construction Engineer should check all Diaries to make sure all days are accounted for. From the Generate Estimate window, the ending date should be entered and the type of Estimate should be selected (i.e., Progress, Final, Supplemental), and, finally, the Generate button should be clicked to submit the estimate.

101.6.4.2 Approving Estimates

The Estimate can be approved by up to five levels of approval. From the Approve Estimate window, select the desired Contract from the list box. Select the desired estimate and click the Approved check box for the appropriate level. Click the Save button.

101.6.4.3 Deleting Estimates

From the Estimate History window, select the estimate. Click the Delete button on the toolbar at the top of the page. The user can only delete Pending estimates. Once the estimate has been approved, it cannot be deleted.

101.6.4.4 Final Estimates

To generate the Final Estimate, all Progress Estimates must be approved. All discrepancies must be resolved before the Final Estimate can be approved. To generate an Estimate, select the Final button on the Generate Estimate panel.

101.6.4.5 Estimate Routing

Estimates will be routed as follows:

1. Monthly Estimates. The original signed copy of the Summary to Contractor Report should be mailed to the Contracts Engineer. A copy of the Summary to Contractor Report should be faxed to Accounting.
2. Final Estimate. The original signed copy of the Summary to Contractor Report and the Item Quantity Report should be mailed to the Contracts Engineer.
3. Contractor. A copy of the Summary to Contractor and the Item Quantity Report should be mailed to the Prime Contractor for all Monthly Estimates and for the Final Estimate. Complete SCDOT Form 100.05 – Contractor Concurrence and Prompt Payment.

101.6.5 Payrolls

The first time a Contractor's payroll is recorded, the Contractor must first be selected from the Services / Choose Keys option on the menu bar. Once selected, the user will enter the Date Received, Ending Date, and Select the Certified check box. No payrolls can be entered until the Work Begin Date has been submitted via the Director of Construction Intranet Page. Users are not required to enter individual employee information on subsequent tabs. Payrolls should be certified for the Prime Contractor every week throughout the life of the Contract. Subcontractors, on the other hand, should only be certified for the weeks that they are on site. If a Prime Contractor is not present for a given week, the user must complete the certification process as mentioned above and click the No Employee Hours Worked check box. To see all

payrolls entered for a given Contractor, click on the Open button and select the Contractor. The pick list will display all payrolls entered for that Contractor, if that payroll has been certified.

101.6.6 Stockpiles

101.6.6.1 Creating Stockpiles

To create a stockpile in SiteManager, the stockpiled material must first be in compliance with the Contract Specifications. Before payment to the Contractor can be made for a stockpile, it is to be entered in the Stockpiles window in SiteManager, making sure to enter the invoice number, the correct information on the form and the Initial Invoice Payment.

101.6.6.2 Installation of Items

The stockpile amount paid to the Contractor will be displayed on the front sheet of the Summary to Contractor Report, minus any quantities installed that estimate period. The per-unit amount previously paid to the Contractor will continue to be subtracted from the total Stockpile amount as items are installed. This will continue for each stockpile until each one has been depleted and the amount on the front sheet reaches zero.

101.6.6.3 Closing Stockpiles

If a stockpile is to be manually closed out, the user should click on Services and then Close out Balance. This will subtract the remaining dollar amount for that stockpile from the Summary to Contractor report.

101.6.6.4 Replenishing Stockpiles

If a stockpile is replenished, the user must click on Services and then Replenish Material, entering the required information. This should be done instead of creating a new stockpile for that item.

101.7 RESOURCE AND COMMUNICATION CONSIDERATIONS

101.7.1 Revisions to the Manual

Recommended changes or additions (e.g., errata, enhancements) to the *Construction Manual* will be received by the Director of Construction. Upon receipt, the recommendations will be reviewed by the Evaluation Committee, which is comprised of SCDOT and FHWA personnel. If approved, updates to the publications will be provided. This is a recurring process that is scheduled as deemed necessary by the Director of Construction. Updates will be made available through the SCDOT Intranet and Internet Web Sites, electronic mail and standard mail, as appropriate.

101.7.2 SCDOT Intranet and Internet Web Site

Most of the Department's information applicable to construction projects is maintained in electronic format on the SCDOT Intranet and Internet Web Site. Significant other information about specific SCDOT operations is also available. The SCDOT Intranet is also used quite frequently during the administration of a construction Contract to communicate between Central, District and Resident Offices (e.g., Material Test Reports).

101.7.3 Inquiries from the Media

Because transportation facilities and services provided by SCDOT are vital to the citizens of South Carolina, the Department receives numerous inquiries from the media regarding the status of various projects, funding, regulations, etc. To ensure that the most accurate and current information is always provided to the media, whether it be newspaper, radio or TV, media inquiries concerning the issues of highway funding, new projects, project updates and any issues that could be considered controversial or sensitive should be referred to the Director of Communications. The Director will be responsible for contacting the appropriate individuals to obtain the information requested and then discussing the issue with either the State Highway Engineer or Director of Construction before contacting the media. An exception to this procedure is answering routine questions regarding construction operations. Another exception to this policy is public meetings where information is provided to the public and the media and where questions are answered face-to-face. This procedure also pertains to press releases. The Communications Office will write and distribute all press releases, except those addressing traffic operations or weekly construction and / or maintenance notices that are routinely provided to the media by District or Resident Offices.

101.7.4 Public Notification

101.7.4.1 Construction Projects

To keep the traveling public informed of construction projects and any delays or closures associated with construction projects, each District should inform the Communications Office by e-mail on a weekly basis. This information should include a listing of construction projects in the District with any lane closures, road closings or special circumstances that may cause traffic delays. The Office will publicize this information and place it on the SCDOT Internet Web Site. This list should be updated every week or, if a special situation occurs, it should be updated as soon as practical.

101.7.4.2 Bridge Replacement Projects

SCDOT requires that the public, legislators and other local officials be properly notified of bridge closings and replacement projects. This notification will be provided through press releases, letters and similar methods. Once a bridge replacement project is let to Contract and awarded, District personnel will send the information to the Communications Office so that a proper notification can be prepared. The following information is required:

- County, route and crossing;
- local road name and/or local bridge name;
- whether the bridge is to be closed or whether traffic will be maintained during construction (explain if traffic will be maintained by off alignment, detour bridge or staging);
- date of expected closure; and
- approximate length of closure and/or completion date.

Other methods of notifying the public may also be used on a case-by-case basis, such as signs, letters to property owners, etc. Figure 101B presents the distribution list that should be used for press releases.

| Item | Responsible Office |
|---|---|
| Local Newspaper(s)/Media outlets | Communications – News Release |
| City, County and/or Regional Chamber of Commerce | Communications – News Release |
| US Senator(s) and/or US Representative(s) | District Engineering Administrator – Letter from State Highway Engineer |
| State Senator(s) and Representative(s) | District Engineering Administrator – Letter from State Highway Engineer |
| SCDOT District Commissioner | District Engineering Administrator – Letter from State Highway Engineer |
| COG and MPO Representatives (as appropriate) | District Engineering Administrator |
| Chairman of the County Council | District Engineering Administrator |
| County Administrator/Manager | District Engineering Administrator |
| County Planner | District Engineering Administrator |
| Chairman of City Council | District Engineering Administrator |
| Mayor (if different from above) | District Engineering Administrator |
| City Planner and/or Manager | District Engineering Administrator |
| Emergency Response Personnel and School Districts | District Engineering Administrator |
| Local US Post Office | District Engineering Administrator |

DISTRIBUTION LIST FOR PRESS RELEASES
Figure 101B

| MATERIAL OR PRODUCT | MINIMUM SIZE OF EACH SAMPLE | MINIMUM FREQUENCY OF SAMPLING | RESIDENT CONSTRUCTION ENGINEER TO TEST FOR | REMARKS |
|--|--|--------------------------------------|---|--|
| Admixtures, Concrete | — | — | Approval Sheet 5 and/or Approval Sheet 53 | See Section 501 and Section 701. |
| Aggregates, Coarse Non-HMA | See SC-T-1, SC-T-3, and SC-T-4. | Each 500 tons. | Gradation and Approval Sheet 2 | Submit one sample of each type, each Contract. See Section 501, Section 701, and Section 802. |
| Aggregates, Fine Non-HMA | 10 pounds See SC-T-2, SC-T-3, and SC-T-4. | Each 500 tons. | Gradation and Approval Sheet 1 | Submit one sample of each type, each Contract. See Section 501, Section 701, and Section 802. |
| Blocks, Concrete | 5 blocks | Each source. | — | — |
| Cable Strand | One (1) 40 inch and One (1) 12 inch | Each 5 reels per heat number. | — | Sample at prestress yard. |
| Castings, Catch Basins Drop Inlets | — | — | Dimension | Inspect all castings for workmanship. See Section 719. Manufacturer's Certification Required. |

| MATERIAL OR PRODUCT | MINIMUM SIZE OF EACH SAMPLE | MINIMUM FREQUENCY OF SAMPLING | RESIDENT CONSTRUCTION ENGINEER TO TEST FOR | REMARKS |
|--|------------------------------------|--|---|--|
| Cement, Fly Ash | 1 gallon | Each 50 tons | — | See Section 501 and Section 701. Mill Test Report Required. |
| Cement, Portland & Slag | 1 gallon | Each 100 tons. On large paving and modified base projects, rate determined by the Research and Materials Engineer | — | See Section 701. Mill Test Report Required. |
| Concrete, Structural, Prestressed, Lean & Other | — | As needed to control consistency. | Slump | Test when consistency is questionable and when cylinders are made. |
| | — | As needed to control % entrained air. | Air Content | Test when air content is questionable and when cylinders are made. |
| Concrete, Structural | Three (3) 6-inch cylinders. | See Section 701. | Make specimens for compressive strength. | AASHTO T-23 (ASTM C 31) |
| Concrete, Prestressed | Six (6) 4-inch cylinders. | See Section 704. | Make specimens for compressive strength. | AASHTO T-23 (ASTM C 31) |
| Concrete, Lean | Four (4) 6-inch cylinders. | One (1) set each one-half day's production. | Make specimens for compressive strength. | Contact Laboratory. |

| MATERIAL OR PRODUCT | MINIMUM SIZE OF EACH SAMPLE | MINIMUM FREQUENCY OF SAMPLING | RESIDENT CONSTRUCTION ENGINEER TO TEST FOR | REMARKS |
|---|-----------------------------|---|--|--|
| Concrete Pavement | — | Four (4) each day's run and each time test specimens are made. | Slump | AASHTO T-19 (ASTM C143) |
| | — | Four (4) each day's run and each time test specimens are made. | Air content | AASHTO T-196 (ASTM C 231) or (ASTM C 173) |
| | Four (4) flexural beams | One (1) set each 1500 cubic yards, or part thereof. Minimum one (1) set per day. | Make specimens for flexural strength. | See SC-T-46. |
| Curing Compound, Spray-On/ Brush-On Concrete Coatings | — | No samples required. | Approval Sheet 7 or Approval Sheet 33 | Not necessary to sample pre-approved material. See Section 702. Manufacturer's Certification |
| Joint Material, Structural and Pavement | See Section 702. | See Section 702. | — | See Section 702. |
| Pipe Culverts, Concrete | — | — | Visual Flaws | Must be pre-tested and stenciled. See Section 714. |

| MATERIAL OR PRODUCT | MINIMUM SIZE OF EACH SAMPLE | MINIMUM FREQUENCY OF SAMPLING | RESIDENT CONSTRUCTION ENGINEER TO TEST FOR | REMARKS |
|----------------------------------|---|--------------------------------------|---|------------------|
| Steel, Reinforcing | 40 inches (30 inches Charleston Lab.) | Each size, each shipment. | — | See Section 703. |
| Water | 1 gallon | Each source. | — | See Section 701. |
| Waterproofing, Asphalt or Tar | — | — | — | See Section 702. |
| Waterproofing, Fabric | — | — | — | See Section 702. |
| Wire, Reinforcement | One (1) 40-inch length. | Each size, each shipment. | — | See Section 703. |
| Wire Mesh Reinforcement | One (1) 24 inch x 24 inch sample. | Each size, each shipment. | — | See Section 703. |

Section 701

Portland Cement and Portland Cement Concrete

701.1 DESCRIPTION OF WORK

The requirements for Portland cement and Portland cement concrete are governed by the provisions of Section 701 of the *Standard Specifications*, including applicable Supplemental Specifications and Special Provisions. The Contractor will be responsible for furnishing the required component materials, properly storing and handling the materials and for proportioning, mixing and delivering an acceptable concrete mixture of the specified class.

701.2 PRECONSTRUCTION CONSIDERATIONS

701.2.1 Concrete Quality and Temperature Control

The Contractor is responsible for all personnel, methods and procedures to control the quality of work and materials during the project, which must be consistent with the QC/QA requirements specified in the Contract and required by the Research and Materials Engineer. The minimum level of Quality Control, Quality Acceptance and Independent Assurance Samples and Tests are presented in Section 106. During periods of extreme hot or cold temperatures, concrete production will not be permitted without a Cold and Hot Weather Batching and Mixing Plan accepted by the District Construction Engineer. The Cold and Hot Weather Batching and Mixing Plan describes methods that will be used to control concrete temperatures within specified limits during batching, mixing, placement and curing. Control methods include, but are not limited to:

- scheduling finishing and curing immediately behind the pour;
- heating of mixing water and using heated and insulated aggregate bins;
- using insulated forms and curing blankets (requires product data sheet);
- using tarps and dry heat, while maintaining moisture during curing;
- sprinkling of aggregate and using chilled mixing water, shaved ice or special cement;
- prewetting forms and subgrade, where applicable;
- erecting windbreaks;
- using a fog spray to promote evaporative cooling without damaging surface; and
- rescheduling.

Temperatures must be in accordance with the Contract Specifications for the type of work. The Contractor will submit the Cold and Hot Weather Batching and Mixing Plan and the topic of quality and temperature control will be discussed at the Preconstruction Conference or Pre-Pour Conference, if required. Do not permit the Contractor to begin work until the methods of quality and temperature control have been discussed and agreed upon. Prior to beginning work, ensure that the required materials for temperature control are at the job site. During construction, observe Contractor operations and monitor the temperature of the concrete for compliance at the plant and prior to placement. Contact the District Office or Bridge Construction Engineer, as needed, for assistance.

701.2.2 Certification of Concrete QC / QA Personnel

The Department requires certification of all SCDOT and Contractor personnel involved with inspecting, sampling and testing concrete. All such personnel must be certified by the SCDOT Certification Program. It is the responsibility of the Resident Construction Engineer to ensure that all Concrete QC / QA Technicians and Concrete Technicians are SCDOT-certified. See the SCDOT Technician Certification Policy for additional information.

701.2.3 Responsibilities of Concrete QC / QA Personnel

The provisions of the Contract will define the QC / QA sampling and testing responsibilities of SCDOT and Contractor personnel. If Contractor QC / QA is specified, the SCDOT Inspector will observe the Contractor's Concrete QC / QA Technician perform the required QC / QA sampling and testing; otherwise, the SCDOT Inspector will perform these duties. The SCDOT Inspector has the authority to instruct the Contractor to correct minor problems; however, if major problems are encountered, notify the Contractor to halt work and contact the Resident Construction Engineer. The Resident Construction Engineer will assess the situation and determine the best course of action to take in the interest of the Department, which may include:

- rejecting the work or material and requiring replacement at no additional cost,
- accepting the work or material with a reduction in payment to the Contractor, or
- requiring the work or material to be modified or improved to correct the deficiency.

The SCDOT Inspector will document the work performed each day, including material quantities and any noteworthy observations. These records will be recorded in the Daily Work Report and appropriate SCDOT Construction Forms for use by the Resident Construction Engineer. The disposition of all failing materials will be reported on SCDOT Form 100.09 – Report of Disposition of Materials Failing to Meet Specifications. The Resident Construction Engineer will approve the Daily Work Reports in SiteManager's Daily Diary and, at the end of each month, will use the approved entries as the basis for generating the Monthly Estimate, which will be forwarded to the Central Office to initiate payment to the Contractor.

When structural concrete is furnished by a transit or central-mix plant (e.g., Ready-Mix plant), an SCDOT-certified Concrete Technician must be present, who may be an employee of SCDOT, the Contractor, a concrete supplier or an independent testing laboratory, as defined in the Contract. The Concrete Technician will maintain records of mix design, batch proportioning and quantities of materials delivered to the project. Retain copies of these records in the project files, and do not accept delivery of batched concrete without proper compliance documentation, which must be signed and certified by the Concrete Technician on SCDOT Form 700.04 – Ready Mix Concrete Report. Note that, unless otherwise directed by the Resident Construction Engineer, these provisions are not required for Class 2500 concrete.

701.2.4 PCC Mix Materials

701.2.4.1 Material Source Approval

Many materials used for concrete construction are supplied from pre-approved sources. The Research and Materials Engineer is responsible for the evaluation and approval of these sources. SCDOT Inspectors will be responsible for ensuring that materials required for concrete construction are supplied from sources listed on the following SCDOT Approval Sheets:

- Approval Sheet 1 – Fine Aggregate Sources for Concrete,
- Approval Sheet 2 – Coarse Aggregate Sources,
- Approval Sheet 3 – Fly Ash for Portland Cement Concrete,
- Approval Sheet 5 – Chemical Admixtures and Air Entrainment Agents for Concrete,
- Approval Sheet 6 – Authorized Portland Cement and Non-Steel Slag Manufacturers,
- Approval Sheet 18 – Authorized Type I (SM) Slag-Modified Portland Cement Manufacturers,
- Approval Sheet 28 – Ready-Mix Concrete Plants Inspected by SCDOT,
- Approval Sheet 32 – Stabilizer Agents for Mixer Drum Wash Water, and
- Approval Sheet 53 – Corrosion Inhibitors for Concrete.

The Contractor is responsible for notifying the Resident Construction Engineer prior to any change in material source, which may require submission of a new Mix Design for review by the Research and Materials Engineer.

701.2.4.2 Cementitious Materials

The cementitious material used in concrete is primarily Portland cement, but may also include fly ash, silica fume or water-granulated blast-furnace slag. The maximum allowable quantity of fly ash and slag will be defined in the Contract Specifications. Verify that cementitious materials are supplied from a source listed on SCDOT Approval Sheet 3, SCDOT Approval Sheet 6 or SCDOT Approval Sheet 18, as appropriate, and that its source is the same as that designated on the Mix Design. Sampling and testing will be performed in accordance with SC-T-47 (see Appendix C) and the frequency schedules presented in Section 106. Obtain the Mill Test Reports for fly ash, slag and cement. All Mill Test Reports must contain the required statement of certification. Ensure that a properly completed Sample Identification Card (see Appendix B) is affixed to the sample when shipped to the Research and Materials Laboratory with a copy of the Mill Test Report. Consider the following when completing the Sample Identification Card:

1. Portland Cement. For Portland cement, the Sample Identification Card must contain the following:
 - manufacturer;
 - type of cement;
 - silo number and grind date for domestic cement;
 - ship name and arrival date for foreign cement;
 - supplier source and location;
 - quantity shipped;
 - date shipped; and
 - destination.

2. Fly Ash. For fly ash, the Sample Identification Card must contain the following:
 - supplier source and location;
 - shipping identification (e.g., silo, truck, as appropriate);
 - quantity shipped;
 - date shipped;
 - purchaser; and
 - destination.

3. Slag. For slag, the Sample Identification Card must contain the following:
 - producer, source and location;
 - grade;
 - date of shipment;
 - tanker number;
 - silo number; and
 - date of production.

4. Silica Fume. Do not sample. Obtain the certification and send it to the Research and Materials Engineer.

The Research and Materials Laboratory will perform tests on samples received. If tests confirm that a shipment is not in compliance, use of the source will be discontinued until compliance can be verified. Material that fails compliance testing will be promptly removed so that it will not be incorporated in the work. The Contractor is responsible for replacing Portland cement concrete produced with defective cement.

Cementitious materials from different sources and of different types must be stored separately in weatherproof facilities. Bulk cement is typically stored in bins or silos and bagged cement is typically stored in buildings or covered pallets. This material must be kept dry. Dark clumps are a sign of previous wetting and may be grounds for rejection. Material that is lumpy, caked, or discarded from open or otherwise damaged bags must not be used. In addition, the material must be handled in such a manner to prevent loss due to dusting, which can greatly affect the water-cement ratio of a batch. During production, cement will be measured by weight in a

certified weigh hopper that is separate from that used for aggregate material. Do not permit the use of fractional bags of cement, unless the cement is being proportioned by weight in a weigh hopper.

701.2.4.3 Aggregate Materials

The Mix Design assumes aggregate to be in a saturated surface-dry condition. As such, determining the amount of free moisture is necessary to ensure that the maximum allowable water-cement ratio is not exceeded. A minimum of two moisture tests should be performed daily on fine aggregate. The moisture of the coarse aggregate is assumed to be 0.5%. The need for additional testing will depend on the uniformity of the supply and any appreciable changes in weather, such as after it rains. Consider the following:

1. Fine Aggregate. Fine aggregate will be natural sand, manufactured sand, or a blend of the two, supplied from a source listed on SCDOT Approval Sheet 1. If a blend is used, the components must be stored and batched separately. Fine aggregate must meet specified criteria for organic impurity (AASHTO T 71), soundness (AASHTO T 104) and gradation and will be subject to sampling and testing as discussed in Section 106. Upon delivery, visually inspect the fine aggregate for unacceptable lumps, organics, trash and debris. Sampling and Testing Methods SC-T-2, SC-T-3 and SC-T-4 will apply (see Appendix C).
2. Coarse Aggregate. Coarse aggregate will be clean, tough, durable gravel, crushed gravel, crushed stone, crushed slag or an approved combination supplied from a source listed on SCDOT Approval Sheet 2 and appropriate for the concrete type being used. Where routine testing of material has not been performed during prolonged stockpiling, obtain and forward samples to the Research and Materials Laboratory prior to use. Coarse aggregate must meet specified criteria for Los Angeles Abrasion (AASHTO T 96), soundness (AASHTO T 104), gradation and will be subject to sampling and testing as discussed in Section 106. Sampling and Testing Methods SC-T-1, SC-T-3 and SC-T-4 will apply (see Appendix C).

Aggregate materials from different sources or of different grading must be separately maintained in stockpiles and bins to avoid intermixing, segregation and contamination. Check the location and preparation of stockpiles, the use and maintenance of bins and the handling of aggregate materials for compliance. Stockpiles should generally be constructed on a clean, well-drained foundation in 3-foot layers without coning. Become familiar with the appearance of the graded aggregate and monitor its handling from stockpile to bin. Check for signs of segregation, intermingling, contamination and breakage. Segregation is common and typically begins with improper handling. Serious segregation is grounds for rejection. In addition, the Mix Design assumes the aggregate to be in a saturated surface-dry condition. Excessively dry conditions may warrant wetting at night and sprinkling during the day, with the excess water being allowed sufficient time to drain (i.e., typically 12 hours). Verify that moisture tests are conducted as specified, and require additional testing as conditions warrant. Such monitoring is critical to maintaining slump and the water-cement ratio within tolerance. The water content must be field adjusted to compensate for changes in moisture in the aggregate. All moisture adjustments must be made in accordance with the batch chart supplied by the Structural

Materials Engineer for the Mix Design. During production, each fine and coarse aggregate fraction for the batch will be weighed separately in the weigh hopper on certified scales. Once established for production, do not permit a change in material source without written authorization from the Research and Materials Engineer.

701.2.4.4 Water and Stabilizer Agents

Water used in mixing, fogging or curing concrete and for mixer drum washing must meet the requirements of the tests defined in the Contract Specifications. Stabilizer agents used for mixer drum wash water must be supplied from a source listed on Approval Sheet 32. Water from a public supply or a previously approved source does not need to be sampled or tested prior to use. However, water from other sources must be tested and approved by the Research and Materials Engineer and frequently monitored for compliance. A minimum of 1 gallon of water will be submitted to the Research and Materials Laboratory in a plastic container. Metal containers must not be used. Testing of water samples requires a minimum of 8 calendar days, so the sample should be submitted well in advance of the proposed date of use. Where water is drawn from a stream or reservoir, ensure that the pipe intake is covered with wire mesh and maintained clean. Where water is hauled to the job site, check that haul containers are clean and properly covered.

Water used in the concrete mix will be measured by either volume or weight, assuming 8.33 pounds per gallon. If measured by volume, a calibrated auxiliary tank may be used. If weighed, it must be weighed separately on a certified scale. The accuracy of measuring water will be frequently checked to ensure that the quantity delivered is within specified tolerance. Pay particular attention to leaks in water containers and dispensing lines that would reduce the quantity once measured for a batch.

701.2.4.5 Admixture Materials

Admixtures are those ingredients in concrete, other than Portland cement, water and aggregate materials, that are added immediately before or during mixing to adjust properties of concrete, such as workability, finishability, strength, durability, watertightness and wear resistance. The primary reasons for using admixtures are to achieve certain properties in concrete more effectively than by other means; to ensure concrete quality during mixing, transporting, placement and curing in adverse weather conditions; and to overcome certain emergencies during concrete placement. Admixtures commonly used in concrete include:

1. Air-Entraining Admixtures. Air-entraining admixtures are used to entrain very small air bubbles in the concrete. Air-entrainment will dramatically improve the durability of concrete exposed to moisture during cycles of freezing and thawing and chemical deicers. The workability of fresh concrete is also improved significantly and segregation and bleeding are reduced or eliminated. Air-entrainment is required for Class 2500, Class 3000, Class 4000, Class 4000S and Class 6500. Also, certain structural elements require air-entrainment, regardless of the class, as specified in the Contract Specifications.

2. Water-Reducing Admixtures. Water-reducing admixtures may be used to reduce the quantity of mixing water by 5% to 30%. Water reducers may be added to concrete without reduction in water to improve workability. The major benefit of reducing mixing water is the increase in concrete strength.
3. Retarding Admixtures. Retarding admixtures are used to retard the rate of setting when concrete is exposed to high temperature during placement, hauled a long distance, or a large quantity is being placed. A practical alternative is to cool the mixing water or the aggregates. A water-reducing set retarding admixture is commonly used in concrete that is deposited under water and in concrete that is not likely to reach its final position in the forms prior to taking its initial set. Some reduction in strength at an early age will accompany the use of retarders.
4. Accelerating Admixtures. Accelerating admixtures are used to accelerate the strength development of concrete at an early age. This, however, can also be achieved by using high-early strength Portland cement, lowering the water-cement ratio by adding cement and by curing at higher temperatures. Calcium chloride is commonly used as an accelerating admixture, but may cause drying shrinkage, corrosion and discoloration. Calcium chloride is forbidden in steel reinforced concrete.
5. Corrosion Inhibitors. Where a corrosion inhibitor is specified, verify that it is supplied from the source specified on the Mix Design.

Sampling and testing of approved admixtures will not be required during the project; however, SCDOT Inspectors must ensure that the admixture is properly identified, is supplied from a source listed on SCDOT Approval Sheet 5 and appears in good condition. If material quality is questionable, suspend use and contact the Research and Materials Engineer.

Admixtures from different sources and of different types must be stored separately in closed containers to prevent contamination and dilution. Admixtures will be dispensed in the proportion recommended by the manufacturer. The accuracy of the dispensing method (e.g., graduated sight tube, metering device) will be frequently checked to ensure the quantity is within specified tolerance. Pay particular attention to leaks in containers and dispensing lines that would reduce the quantity once measured for a batch. The most common admixture used is an air-entraining agent. The addition of air-entraining admixture to adjust air content is permitted after mixing using the method prescribed in the Contract for the class of concrete being produced.

701.2.5 PCC Plant and Hauling Equipment

701.2.5.1 Certification and Inspection

Prior to producing concrete for SCDOT projects, the Contractor will make arrangements for a thorough compliance inspection of concrete production and transport facilities (e.g., batch plant, Ready-Mix plant, scales, meter proportioning equipment, trucks, field laboratory, sampling and testing equipment, material sources, mix design, batch charts, personnel) to be performed by the Research and Materials Engineer on an annual basis. These items will be inspected for Contract compliance and any required certifications from SCDOT. Inspections then will be performed at least annually and at other times during production, as deemed necessary. Note

that Ready-Mix plants will be inspected and approved in accordance with SCDOT Approval Policy 28 and, if proposed for use on the project, must be listed on SCDOT Approval Sheet 28. The Plant Approval Letter must be current and accurately document the concrete to be supplied for the project (e.g., type, batch size). The Plant Approval Letter will include the following information:

- plant identification, type and capacity;
- date of last inspection;
- list of SCDOT-approved stockpiled materials;
- date of last scale certification;
- date that scales need to be re-certified; and
- a list of approved truck mixers to be used on the project.

Mixing drums will have a manufacturer's rating plate showing drum capacity and recommended drum or blade operating speed (i.e., revolutions per minute). Each truck mixer will receive an SCDOT approval decal showing truck identification number and maximum gross volumetric drum capacity for both agitating and mixing operations. The concrete volume in the drum cannot exceed the maximum rating, and truck identification numbers must be used to document the concrete supplied to the project. Prior to production, ensure that production and transport facilities have been inspected and approved, displaying current un-expired SCDOT approval decals. Become familiar with typical operation and condition and periodically check for signs of unacceptable use or condition. Do not adjust equipment settings, scales or metering equipment, because this is the Contractor's responsibility.

701.2.5.2 Scales and Metering Devices

The Contractor is responsible for maintaining and calibrating scales and metering devices used for proportioning materials for concrete batches. Although SCDOT Inspectors will verify and document checks of scales and metering devices, they should never attempt to repair or adjust such equipment. If problems are encountered, halt production and ensure that the device is serviced and recalibrated by a qualified technician. Consider the following:

1. Scale Certification. If the concrete plant is within South Carolina, scales will be inspected annually for accuracy by the Division of Weights and Measures, South Carolina Department of Agriculture or by other qualified scale service agents. The Letter of Certification or Seal on the scale indicates only that the device was within tolerance at the time it was tested. Periodic checks must be made to ensure compliance, because dirt on balance arms, wear of knife edges and foundation settlement can change scale sensitivity and accuracy.
2. Metering Device Checks. Water and admixture dispensers should be checked at frequent intervals. Such devices can be checked by drawing off and measuring a quantity of material to determine if the proportion is within specified tolerance of the quantity required for the batch. If the device fails to meet this criteria, inform the Contractor to halt production and have the problem corrected. Repeat the test to verify proper recalibration of the device.

701.2.5.3 Concrete Mixers

The purpose of the mixer is to combine the proportioned component materials into a homogenous mass, ensuring that all aggregates are thoroughly coated with cement paste. The purpose of the truck mixer, when used as an agitator, is to prevent segregation of the mix en route to the site. Mixing time and number of revolutions will be specified and should be checked periodically using the drum revolution counter after zero reset. This criteria may be adjusted for field conditions based on the recommendations of the Research and Materials Engineer. Mixers should be inspected periodically for accumulation of hardened mortar and wear of blades. Such inspections are critical to ensuring optimum mixer performance. Consider the following:

1. Blade Wear. The mixer's blades should be carefully inspected and monitored for wear. The majority of wear will occur at the center of the blade with very little wear at the tips. If worn 1 inch or more below the original height of the manufacturer's design, discontinue use of the mixer until the blades can be repaired or replaced. The Contractor is responsible for providing the manufacturer's brochure showing the original dimensions and arrangement of the blades. To check blades for excessive wear, permanent marks (e.g., holes 0.25 inches in diameter) can be provided 1 inch from the edge of new blades near the midpoint of the length of each blade. This will provide a quick visual check for excessive blade wear.
2. Cleaning. The throat of the drum and the mixing blades can become fouled with hardened or semi-hardened concrete and, if left unchecked, can cause ineffective mixing and fouling of subsequent batches. Ensure that mixers are properly cleaned at suitable intervals. Causes of obvious mortar leaks and spills should be corrected immediately.
3. Wash Water and Stabilizers. Wash water, if not completely drained from the mixer, will invariably be used in a succeeding batch. During daily production, require the mixer to be completely drained between batches. If a stabilizer agent is used for overnight or weekend treatment, ensure the procedure complies with current SCDOT policy for the brand of stabilizer used. These provisions must be strictly enforced.

701.2.6 PCC Mix Design

Many factors can influence the physical properties of concrete. As such, several trials may be necessary to initially establish an acceptable concrete mix. The design process will begin at least 45 days prior to concrete placement and will include the evaluation of trial batches mixed from component materials proposed for the project. The allowable material proportions for the class of concrete required will be defined in the Contract Specifications. The Mix Design will be developed by either an AASHTO-accredited independent laboratory or the Contractor's Concrete QC / QA Technician in an SCDOT-approved laboratory. The Contractor will submit the Mix Design, including mixing sequence, to the Research and Materials Engineer for review. The Mix Design will address the following specified criteria:

- mix proportioning for the required class of Portland cement concrete;
- required type and gradation of aggregate;

- allowable fine-to-coarse aggregate ratio, based on volume and adjusted for workability;
- saturated surface-dry aggregate and specific gravities of materials;
- minimum Portland cement content;
- allowable percentage and ratio by weight of other cementitious materials;
- maximum water-cement ratio (i.e., water to all cementitious material by weight);
- allowable range of air-entrainment and other needed chemical admixtures;
- minimum 28-day compressive strength;
- maximum concrete temperature; and
- consistency and workability (i.e., slump) for the method of concrete placement.

Upon satisfactory review, the Mix Design will be used to produce an initial trial batch, which will be sampled and tested for air content, slump, unit weight, temperature, 28-day compressive strength and time of set. As needed, proportioning will be adjusted and additional trial batches will be produced, sampled and tested until the Mix Design and mixing sequence demonstrate that the concrete meets specified criteria. Testing of trial-batches will be performed by either the Research and Materials Laboratory or the Contractor's Concrete QC / QA Technician in an SCDOT-approved laboratory under the direct supervision of Research and Materials Laboratory personnel. The Mix Design, documenting the mix proportions and water-cement ratio required to produce concrete of the specified strength, will be forwarded to the Contractor and Resident Construction Engineer.

701.3 INSPECTION DURING CONSTRUCTION

701.3.1 Batching and Mixing

Portland cement concrete will be batched and mixed in an SCDOT-approved plant and transported to the project site. Material proportioning will be performed using pre-approved scales and metering equipment, based on an Mix Design. Compliance of concrete production and hauling cannot be overemphasized. These operations are key to producing a high-quality concrete. Quality greatly depends on the attention given during each step of production and placement. No amount of extra effort at the job site can compensate for errors at the plant. For the purpose of checking yield, the volume occupied by the concrete should be computed based on the Mix Design. The Batch Chart will specify the weights to be used in the batching process depending on the moisture condition of the aggregate. A decrease in cement content or the addition of water in excess of that allowed on the Batch Chart will not be permitted unless authorized in writing by the Resident Construction Engineer. Do not accept any concrete that is not within the specified slump, air content, or temperature and pay particular attention to compliance with the criteria specified for the elapsed time of haul after water has been added to the cement. Where truck mixers are used and all materials have been charged into the mixer, the revolution counter must be set to zero and mixed at mixing speed for the specified number of revolutions before leaving the plant.

701.3.2 Sampling and Testing

Accurate and representative sampling of work and materials cannot be overemphasized. An improperly taken sample may not be truly representative; and if testing is performed on such a non-representative sample, the test results will be meaningless with respect to assessing quality

and adherence to specified requirements. Section 106 documents the sampling and testing required to monitor concrete mix properties (e.g., slump, air content, temperature, cylinders). Review the sampling and testing procedures required (see Appendix C). See Appendix B for information on Sample Identification Cards. At a minimum, slump and air tests should be performed when cylinders are made. When the results of slump tests or air content tests are not within specified tolerance, reject the mix and inform the Contractor. Verify that concrete test cylinders are made at the proper schedule and in accordance with the specified test procedure. When specified, the Contractor will provide a satisfactory curing box for the 28-day test cylinders to maintain the cylinders at specified temperature until they can be shipped for testing. Additional cylinders may be used to assess the timing for form removal and opening to traffic.

The minimum frequency of sampling concrete for structures will be every 50 cubic yards placed on small pours and every 100 cubic yards placed on large pours. However, this frequency is insufficient for bridge and culvert pours in which the total amount of concrete placed is less than 50 cubic yards. On pours of less than 50 cubic yards, a sample of concrete must be obtained for each pour of each structural item (Le. one sample per each footing, column, culvert wall, etc.). If one truck load of concrete is used to pour more than one structural item (e.g., one truck load used to pour two footings), only one sample is required. This will increase the number of samples taken, but ensure that each structure meets Contract Specifications.

701.4 POST-CONSTRUCTION CONSIDERATIONS

If testing of cylinders indicates that the concrete has not attained the specified 28-day design strength, enforce a reduction in payment, as specified. Pay particular attention to concrete that has not attained at least 90% of the minimum specified strength and enforce the provisions of the Contract with respect to obtaining core samples or other approved methods for acceptability testing. The Resident Construction Engineer and, as needed, the Bridge Construction Engineer and Bridge Design Engineer will determine the limits of concrete that can remain in-place at a reduced price or that must be removed and replaced entirely. If prestressed concrete has not attained the minimum specified strength, notify the Bridge Construction Engineer for additional requirements. Watch for damage to reinforcing steel during coring and ensure the Contractor properly fills all core holes with an approved non-shrink structural grout material. SCOOT Inspectors must keep accurate records of sampling and testing on SCOOT Form 700.04 Ready Mix Concrete Report including slump, air, temperature, location of truck unloading, etc.

701.5 DOCUMENTATION AND PAYMENT CONSIDERATIONS

The quantity of concrete measured for payment will be the number of cubic yards of concrete of each class within the neat lines of the structure as shown on the Contract Plans or as approved by the Bridge Construction Engineer or Road Construction Engineer. Deductions will be made from the quantity for the volume of embedded items other than reinforcing steel and other minor items such as drains, anchor bolts, etc. No deduction will be made for chamfers of 0.75 inch size or smaller. Document these quantities in the Daily Work Report. Retain all materials certifications, invoices and similar documentation.

Section 702 Concrete Structures

702.1 DESCRIPTION OF WORK

The Resident Construction Engineer and SCDOT Inspectors will be responsible for verifying that the work and materials required for each structural element are in compliance with the requirements of the Contract Plans and Specifications, including applicable Special Provisions and Working Drawings.

702.2 PRECONSTRUCTION CONSIDERATIONS

702.2.1 Pre-Pour Conference and Checklist

A Pre-Pour Conference will be held prior to all bridge deck construction and for other structural pours as deemed necessary by the Bridge Construction Engineer or Resident Construction Engineer. Review the minutes of the Pre-Pour Conference, if held, and use SCDOT Form 700.01 – Concrete Pour Inspector’s Checklist.

702.2.2 Concrete Quality and Temperature Control

Ensure that the Contractor’s Cold and Hot Weather Batching and Mixing Plan has been accepted by the District Construction Engineer. See 701.2.1 for additional information on concrete quality and temperature control.

702.2.3 Mass Concrete Placement Plan

If mass concrete placement will be performed, as defined in the Contract, ensure the Contractor has submitted a Mass Concrete Placement Plan and that the Bridge Construction Engineer has accepted the Plan.

702.2.4 Crane Safety Considerations

Ensure that the Contractor has provided the Crane Safety Submittal List to the Resident Construction Engineer, that the requisite plans have been reviewed and that the Contractor, or subcontractor, operates in accordance with the crane safety requirements.

702.2.5 Material Considerations

702.2.5.1 Material Source Approval

The Research and Materials Engineer is responsible for evaluating material sources. SCDOT Inspectors will be responsible for ensuring that materials required for concrete structures are supplied from sources listed on the following SCDOT Approval Sheets:

- Approval Sheet 7 – Spray-On / Brush-On Surface Coatings for Concrete Finish,
- Approval Sheet 8 – Silicone Sealants for Portland Cement Concrete Pavement Joints,
- Approval Sheet 9 – Waterproofing Membrane Under Asphalt Overlay for Concrete Pavement Joints,
- Approval Sheet 33 – Curing Compound for Concrete Structures, and
- Approval Sheet 36 – Approved Monomolecular Polymer Film Products.

702.2.5.2 Portland Cement Concrete

Verify that the Contractor has obtained a Mix Design for the class of concrete to be used for the structure. Verify that truck mixers and other production and hauling equipment have been certified for use on the project. Upon delivery, verify that the Concrete Technician's concrete batch documentation on SCDOT Form 700.04 – Ready Mix Concrete Report indicates compliance with the Mix Design and contains the required information. Ensure that the required samples have been tested and approved. Check and record the discharge time, mix temperature, water-cement ratio, air content, slump and drum revolutions at mixing speed. See Section 701 for additional information.

702.2.5.3 Reinforcing Steel

Verify compliance of the type, size and condition of reinforcing steel. Do not allow the pour to begin without notification of material test approval. Verify that reinforcing steel is properly stored off the ground to prevent rusting and damage. Check compliance of placement, location, size, clearance, cover, ties, dowels and support. See Section 703 for additional information.

702.2.5.4 Expansion and Joint Sealant Materials

Verify compliance of the expansion materials required with respect to type, dimension, length, thickness, weight and condition. Consider the following:

1. Preformed Joint Filler. Fiber / asphalt and fused rubber materials meeting the Contract Specifications will be sampled at the job site and submitted to the Research and Materials Laboratory for compliance testing. Each sample will consist of a strip or section at least 24 inches long by 6 inches wide. If a material Lot has been pretested, it will be so marked and the Resident Construction Engineer will notify the Research and

Materials Engineer of the brand and Lot Number to obtain the Test Reports for the material.

2. Hot-Poured Elastic Filler. Hot-poured elastic filler is primarily used in cracks and expansion joints. Verify that the material meets the Contract Specifications and submit a copy of the manufacturer's certification to the Research and Materials Engineer. Verify compliance of the kettles used for placing hot-poured elastic filler. Excessive smoke is an indication of overheating, which is prohibited. The joint should be filled as shown in the Plans.
3. Elastomeric Compression Seals. Verify compliance of the elastomeric compression seals and the lubricated adhesive for bridge deck and pavement joints. Obtain a copy of the manufacturer's certification and certified test results. Forward a copy to the Research and Materials Engineer. Verify that installation is in accordance with the manufacturer's recommendations.
4. Silicone Sealant. Silicone sealant is a cold placed sealant typically used to fill sawed transverse and longitudinal joints in concrete pavements. It is accepted on the basis of certification and the product must be listed on SCDOT Approval Sheet 8. It is not necessary to submit a sample to the Research and Materials Laboratory. The supplier is required to furnish the following with each shipment:
 - manufacturer's certification showing brand name, shipping date, recipient, quantity and a statement indicating that the material meets SCDOT specifications;
 - container label plainly indicating the manufacturer's name, Lot Number, trademark, type of silicone and end-of-shelf-life date; and
 - a Material Safety Data Sheet (MSDS) and installation instructions.

Silicone sealant must be installed over a backer rod to prevent the sealant from bonding to the bottom of the joint. A manufacturer's certification is also required for the backer rod or other bond breaking material.

5. Bridge Deck Joint Strip Seals. Verify compliance of bridge deck joint strip seals. See Section 723 for additional information on bridge deck joint strip seals.

702.2.5.5 Curing Materials

Curing materials are used on green concrete to prevent moisture evaporation. The materials most commonly used include burlap cloth, sheet material (e.g., waterproof paper, polyethylene film, white burlap-polyethylene sheeting) and liquid membrane-forming compounds. Verify that curing materials are supplied from a source listed on SCDOT Approval Sheet 7 or Approval Sheet 33, as appropriate. Ensure that each shipment is furnished with a proper manufacturer's certification, Materials Safety Data Sheet and application instructions and that the containers show the manufacturer's name, trademark, batch number, type and class of material and date of manufacture. Retain the manufacturer's certification for final materials certification. Note that

liquid curing compounds are usually pressure-sprayed on the surface of the green concrete and usually arrive in 55-gallon drums, which can settle during storage. Verify that the material is properly stirred prior to application. Verify that the material is applied at the specified rate.

702.2.5.6 Surface Coatings for Concrete Finish

Ensure that suppliers of spray-on or brush-on surface coatings for concrete finish are listed on SCDOT Approval Sheet 7. Obtain the manufacturer's certification, certified test results, Product Data Sheets and Material Safety Data Sheets. The letter of certification must contain a statement that the material meets SCDOT specifications. Verify that the containers are marked with the manufacturer's name, trademark, production Lot number, date of manufacture, shelf life and application procedure. Only unopened original containers will be acceptable. Verify that the surface coatings are applied in accordance with the manufacturer's recommendations (e.g., coverage rate, equipment, temperature). No additives will be allowed at the site (e.g., gasoline, kerosene, diesel fuel).

702.2.6 Falsework and Forms

Verify that Working Drawings for falsework and forms have been submitted and reviewed by the Bridge Construction Engineer (see Section 725). Verify that the Contractor's falsework and forming operations comply with the details of the Working Drawings. Use telltales, as needed, to monitor unacceptable movement during erection, fastening and when the concrete is poured. Immediately notify the Contractor of any non-compliance or safety concerns. Contact the Resident Construction Engineer or Bridge Construction Engineer, as needed, for assistance. See Section 702.10 of the *Standard Specifications*. Consider the following:

1. Forms. Check compliance of the type, size and condition of the forms prior to erection and ensure that unsuitable form materials are rejected and removed from the job site. Check that the forms are of adequate thickness and design to remain true to shape and that they present a smooth surface finish.
2. Falsework and Form Erection. Verify that falsework is erected in conformance with the Working Drawings. Ensure that the Contractor, a certified Inspector or registered professional engineer inspects and certifies the erection of falsework and forms, as specified. Deviations from the Working Drawings are not allowed without written approval by the Contractor's professional engineer. Verify that form joints align properly. Verify acceptability of the form ties being used. Forms should be mortar tight and sufficiently rigid to prevent excessive deflection during the pour. Check that forms are properly located with respect to grade and alignment.
3. Form Preparation. Verify that all embedded materials (e.g., conduits, drains, utility blockouts, anchoring devices) are placed and adequately secured and that all required chamfer strips are in place. Verify that the inside surfaces and cavities are cleaned of all dirt, mortar, chips, sawdust and other foreign materials and that an acceptable form oil is being used. The form release agent must be compatible with the finish coating to be applied once the forms are removed. Ensure that forms are wetted down and thoroughly moistened prior to the pour.

4. Stay-in-Place Forms. Where stay-in-place steel bridge deck forms are used, closely inspect the forms for compliance. Verify that the erection and installation of the forms are in accordance with the details of the Contract Plans and Working Drawings and that tack welds, screws and other attachments are made by approved methods. Check to ensure that the Contractor has prevented any welding from contacting steel girders. No welding is allowed on permanent steel members for falsework erection (see Section 702.11(c) of the *Standard Specifications*).
5. Traffic and Safety Issues. Verify that provisions with respect to protecting vehicular and pedestrian traffic have been adequately addressed and that all safety items, including hand rails and toe rails, have been installed to protect workers and the traveling public. Ensure that the Contractor's competent safety person verifies that all OSHA requirements are met.

702.2.7 Joints and Other Embedded Features

Check that open joints, sliding joints (e.g., roofing felt, metal plates, mortis), fixed joints, elastomeric bearing pads (see Section 724), expansion joints and deck joint strip seals (see Section 723) are installed in accordance with the Contract Plans and Specifications and Shop Drawings. No construction joints will be permitted except those shown on the Contract Plans or approved by the Bridge Construction Engineer. Ensure that the Contractor has materials on hand for emergency bulkheads during bridge deck placements. Verify that construction joints are adequately cleaned and that any loose concrete has been removed. Ensure that construction joints are made only at approved locations. Verify compliance of the location, elevation, size and installation of pipes, conduits and drains to be encased in the concrete.

702.2.8 Dry-Run Check for Bridge Deck Pours

For bridge deck pours, require a dry run to check that the support for the screed is rigid and unyielding. Take depth measurements in all bays between beams at quarter points and near the ends of the span. For long spans, it may be necessary to take additional depth checks. The maximum distance between depth checks will not exceed 25 feet. Check reinforcing bar clearance at the same time depth measurements are taken and check the slab depth and clearance along all longitudinal and transverse construction joints. Notify the Bridge Construction Engineer of any variance greater than ± 0.5 inch from Plan dimension. Measurements taken should be recorded on SCDOT Form 700.05 – Dry Run Depth Checks for Bridge Deck Pours. Any adjustments should be made prior to concrete placement.

702.3 INSPECTION DURING CONSTRUCTION

702.3.1 Concrete Placement

Do not permit the concrete pour to begin until the Resident Construction Engineer has approved preliminary items such as depth, character and water conditions of foundations, adequacy of falsework and forms, absence of debris in forms, alignment and grade of forms, conditions of construction joints and condition and spacing of reinforcing steel. Verify that the concrete is

placed in accordance with the approved placement sequence and Cold and Hot Weather Batching and Mixing Plan. Verify that the concrete is placed to avoid segregating the mix or displacing the reinforcing steel or embedded items. Verify that the concrete is not dropped into forms from a height in excess of that specified. Do not allow the use of concrete that will not reach its final position in the forms within the specified time limit. The Inspector should monitor specified pouring rates. If mass concrete placement will be performed, as defined in the Contract, ensure that the Contractor operates within the requirements of the approved Mass Concrete Placement Plan. Carefully monitor the temperature of the concrete during mass concrete placement. Where concrete will be placed under water, Class 4000DS (see Section 712) and Class 4000S concrete will typically be used with special requirements for slump and water-reducing retarders. Verify compliance of the tremie used for underwater placement with respect to type, size and condition. Where the concrete will be poured in tidal water, verify compliance of placement with respect to high and low tide elevations.

702.3.2 Concrete Vibration

All classes of concrete, except Class 4000DS and 4000S for underwater pours, will be vibrated. Ensure that an adequate number of vibrators is available. This will depend on the scope of the pour. At least two are required to ensure backup in case of breakdown. Verify condition, frequency and amplitude for compliance. Vibration will be applied at the point of deposit. Verify that the vibrators are inserted and withdrawn from the concrete slowly. The vibration should be of sufficient duration and intensity to thoroughly compact the concrete without segregating the mix. Points of insertion should be uniformly spaced no farther than twice the radius over which the vibration is visibly effective. Do not allow vibrators to come into contact with forms, ties or reinforcing steel. Spading may be necessary along form surfaces and in corners. Do not allow the use of vibrators to move concrete from one place to another.

702.3.3 Wet Depth Checks

Require a wet depth check to verify slab thickness and reinforcing steel clearance for bridge deck pours. Measurements will be taken in all bays using the longitudinal screed and SCDOT Form 700.07 – Wet Depth Checks for Bridge Decks – Longitudinal. Measurements will be taken for the transverse screed if required by the Resident Construction Engineer and recorded on SCDOT Form 700.06 – Wet Depth Checks for Bridge Decks – Transverse. These forms may be modified to accommodate all bridge configurations. Notify the Bridge Construction Engineer of any variance greater than ± 0.5 inch from Plan dimension.

702.3.4 Removal of Falsework and Forms

The falsework and forms should not be removed until the concrete has set in the forms for the minimum specified period and has attained the minimum specified strength. The falsework and forms will be removed as soon as practicable without damaging the structure (e.g., camber) or the concrete surface in accordance with Section 702.21 of the *Standard Specifications*. Watch for damage to the structure and to concrete surfaces during removal of the falsework and forms.

702.3.5 Initial Surface Finish

After the forms are removed from structural elements, verify that fins are removed and depressions, holes and rough surfaces are filled and pointed as specified. Inspect the surface for cracks, defects and damage and require repairs based on the provisions of the Contract. Verify compliance of the screed and burlap or broom drag finish during bridge deck pours. Limit the use of bull floats and do not permit the Contractor to sprinkle or spray water on the deck for the purpose of finishing. Check that the crown and longitudinal profile are within specified tolerances and are verified using a rolling straightedge as specified.

702.3.6 Concrete Curing

The purpose of the curing operation is to prevent rapid drying and uncontrolled cracking, especially during dry, hot weather. Ensure the Contractor's method of curing has been accepted. Immediately following the final screeding operation of bridge decks, verify the proper use of fog spray to increase the humidity directly above the fresh concrete until the curing material is in place. Do not permit the fogger to spray directly onto the concrete surface. This will weaken the surface and cause premature failure. Ensure that the proper curing compound is applied at the specified rate to all surfaces and edges. Verify the installation and acceptability of other protective measures, such as windbreaks. Such measures must be in conformance with the accepted Cold and Hot Weather Batching and Mixing Plan. Pay particular attention to any gaps in the coverage of curing material and require correction, as necessary. Ensure that each structural item is cured as specified. If unsatisfactory results are obtained, the Contractor will submit modified procedures to the Resident Construction Engineer before the next pour.

702.3.7 Final Non-Wearing Surface Finish Coat

The final exposed concrete surface of structural elements, except for bridge decks, will be given a final sprayed or brushed surface finish coat in accordance with the Contract Specifications. Generally, this treatment will be applied as the final operation prior to final inspection. Verify that the specified period has elapsed and that the concrete surface is dry, clean and at the proper temperature prior to application of the coating. Verify compliance of the color, coverage, coats, texture, thickness and rate of application. The material will be applied in strict accordance with the written instructions of the product manufacturer.

702.3.8 Sidewalks and Curbs

Carefully inspect the line, grade and texture of sidewalks and curbs. They must meet the requirements of the Contract Plans and Specifications.

702.4 POST-CONSTRUCTION CONSIDERATIONS

Where stay-in-place forms for bridge decks are installed, test the concrete soundness and bonding of the forms by sounding with a hammer and inspect the underside of the deck by

requesting removal of form sections, as needed to ensure quality. Examine the concrete surface for cavities, honeycombing and other defects. Require repair work to be performed in accordance with the provisions of the Contract. Do not permit traffic on wearing surfaces until the specified design strength has been achieved, as indicated from testing cylinders or other approved testing methods. Verify that bridge decks are tested for smoothness in accordance with the Contract Specifications. Check compliance of specified tolerance and, as needed, required the surface to be corrected. All rideability corrections must be performed prior to grooving the bridge deck. The Contractor is responsible for notifying the Resident Construction Engineer when ready for this testing. The Resident Construction Engineer is responsible for notifying the Pavement Evaluation Unit to schedule the testing. After curing and all grinding of the deck surface has been completed to meet rideability requirements, check that the surface of the deck slab is grooved as specified. Pay particular attention to the limits of grooving, joints and the depth, width and spacing of the grooves. Ensure that all residue is properly cleaned up and removed from the site prior to final acceptance. No residue will be allowed to fall into open water.

702.5 DOCUMENTATION AND PAYMENT CONSIDERATIONS

Measurement and payment for concrete structures will not be specially made under Section 702 of the Standard Specifications. Measurement and payment will be made in accordance with other Sections, as defined in the Contract Specifications. Document all field notes in the Daily Work Report. Retain all materials certifications, invoices and similar documentation.

Section 703

Reinforcing Steel

703.1 DESCRIPTION OF WORK

The design strength of reinforced concrete structures cannot be fully realized unless the specified reinforcing steel is placed as designated on the Contract Plans. The type and size of reinforcing steel; bar location, spacing, and clearance; and the bond developed between the concrete and the bar surface are critical factors to consider during inspection. Section 703 of the *Standard Specifications*, including applicable Supplemental Specifications and Special Provisions, govern the work and materials related to reinforcing steel that is used on concrete pavements and structures, including deformed bars, wire, wire mesh, bar supports, dowels and tie bars. The Resident Construction Engineer and SCDOT Inspectors will be responsible for verifying compliance of the material furnished and placed on the project.

703.2 PRECONSTRUCTION CONSIDERATIONS

Upon delivery, compare bar bundle tags with Mill Test Reports to ensure that bar size, material grade, and coating meet specified requirements. Spot check bar identification markings for proper steel grade. Check compliance of the reinforcing steel furnished with respect to size, grade and coating, if specified. Ensure that the material has been sampled, tested and approved for use prior to the concrete being poured. Ensure that reinforcing steel is stored on blocks, dunnage, etc. above ground to prevent rusting from standing water. Consider the following:

1. Deformed Rebars. The Research and Materials Engineer does not pre-approve sources or pretest shipments of reinforcing steel bars. Acceptance or rejection will be based on testing 40 inch long samples (30 inch long samples when shipped to SCDOT's Charleston Laboratory) taken in the field upon delivery. Samples of each size bar are to be taken in a random manner and submitted to the Research and Materials Laboratory. The supplier usually furnishes a short piece of each size bar to repair the bar from which the sample is taken. Do not submit this short piece as a sample. If a sample fails to meet specified requirements, obtain and submit a check sample as discussed in Section 106. When check samples are required, the samples should be from the same manufacturer and heat.
2. Galvanized Reinforcing Bars. When specified for use in concrete structures, verify that galvanized reinforcing bars are of the size and grade required. Pay particular attention to the method of bundling, lifting and handling this material to prevent damage to the coating. Tie wires must have a plastic coating to prevent damage to the galvanization. Pay particular attention to damage to the galvanization and require replacement or repair in accordance with the provisions of the Contract.
3. Wire and Wire Fabric. Where designated, verify that the wire and wire fabric reinforcement complies with the requirements of the Contract Plans and Specifications.

4. Mechanical Couplers. Where mechanical couplers are used, verify that the Contractor has furnished the manufacturer's assembly instructions. Acceptance testing will be based on a minimum of one rebar/coupler sample for each size. Test assemblies will be at least 40 inches in length with components being randomly selected from the materials delivered to the project. Witness the assembly of the rebar and coupler test sample and submit the sample to the Research and Materials Laboratory for testing. Ensure that threads and open couplers are protected from damage, debris and weather.
5. Bar Supports. Bar supports and ties are typically used to seat and secure the steel reinforcement within PCC structures. Verify that the wire supports, plastic bar supports and concrete blocks meet specified requirements. Plastic or coated chair supports are typically required to prevent rusting and to meet specified rebar clearances.

703.3 INSPECTION DURING CONSTRUCTION

Consider the following during inspection of reinforcing steel for concrete structures:

1. Bar List. Verify that the Contractor's bar list conforms to the Contract Plans with respect to bar size, quantity and bending details.
2. Bar Condition. Check that reinforcing bars are free of foreign materials. Concrete will only bond with a clean bar surface. In addition, check bars for straightness, and ensure that they are protected from damage. Ensure that any damage to bar coating is adequately repaired.
3. Bar Bending. Become familiar with the bar bending details. Where field bending is required, ensure that the proper procedures are being followed, and verify whether the application of heat is permissible.
4. Bar Alignment and Spacing. Check that bar alignment and spacing conforms with the Contract Plans. Verify that all bars and other embedded items are correctly placed so that the concrete can be adequately consolidated.
5. Handling of Rebar Cages. Verify that the Contractor has an accepted method for lifting large rebar cages for drilled shafts and columns and caps to prevent racking or loosening of the rebar ties.
6. Bar Clearance. Check bar clearance and depth of concrete cover for compliance. Ensure that the proper minimum clearance is obtained between the top mat of deck bars and the surface of the concrete.
7. Bar Splicing. Check bar splices to ensure that they are the proper length for the type and size of bar placed. Verify that bar splices are correctly staggered, if specified.
8. Bar Supports. The type, number and spacing of supports must be adequate to minimize sagging, displacement and damage of reinforcing bars. Plastic or coated supports are required for coated bars. Any damaged bar supports will be replaced or repaired.

9. Securing of Bars. To minimize displacement, bars must be securely tied. Verify that the bars are tied at all intersections or as otherwise designated in the Contract Specifications. Do not permit welding of bars except as noted on the Contract Plans. Note that the use of coated ties are required for coated bars.
10. Post-Tensioned Concrete. Adjustments made to reinforcement in post-tensioned concrete require approval by the Bridge Construction Engineer.

703.4 POST-CONSTRUCTION CONSIDERATIONS

Final approval of the type, placement and condition of the reinforcing steel for concrete structures must be obtained from the Resident Construction Engineer prior to the concrete pour. See Form 700.01 – Concrete Pour Inspector’s Checklist.

703.5 DOCUMENTATION AND PAYMENT CONSIDERATIONS

Reinforcing steel for structures will be measured by the weight of reinforcement placed and accepted. Payment for the quantity of each class of reinforcing steel shown in the plans will be made at the Contract unit price for the appropriate item. Document all measurements, calculations and field notes in the Daily Work Report and appropriate SCDOT Construction Forms. Retain all materials certifications, delivery tickets and similar documentation.

Chapter 11

SC-T-Test Procedures and Additional Field Inspector Concerns

PLEASE NOTE: All current SC-T procedures can be found online at
http://www.scdot.org/doing/materials_test.aspx

| SC-T | Topic | Page Number |
|------|---|-------------|
| 1 | Methods of Sampling Coarse Aggregates | 26 |
| 2 | Methods of Sampling Fine Aggregates | 31 |
| 3 | Methods of Reducing Size of Aggregate Sample | 33 |
| 40 | Procedure to Determine Aggregate Correction Factor Using the Pressure Meter (ASTM C231) | 35 |
| 45 | Slump Loss of Portland Cement Concrete | 38 |
| 46 | Making and Curing Concrete Beam Specimens | 41 |
| 47 | Method of Sampling Portland Cement, Slag, and Fly Ash | 45 |
| 49 | Determining the Rebound Number of Hardened Concrete | 46 |

SC-T PROCEDURES (Chapter 11)



SC-T PROCEDURES

| SC-T | TOPIC |
|------|--|
| 1 | Sampling Coarse Aggregates |
| 2 | Sampling Fine Aggregates |
| 3 | Reducing Size of Aggregate Samples |
| 40 | Procedures to Determine Aggregate Correction Factor using the Pressure Meter (ASTM C231) |
| 45 | Slump Loss of Portland Cement Concrete |
| 46 | Making & Curing Concrete Beam Specimens |
| 47 | Sampling PC, Slag and Fly Ash |
| 49 | Determining Rebound Number of Hardened Concrete |

**** There is a push from HQ for you to know these****



SC-T PROCEDURES

Aggregate Sampling

- **Maximum Size** – The smallest sieve opening through which the entire amount of aggregate is required to pass.
- **Nominal Maximum Size** – The smallest sieve opening through which the entire amount is permitted to pass.



SC-T PROCEDURES

Aggregate Sampling

- **SC-T-1** – Back of Construction Manual



Aggregate Sampling

QUESTION:

When sampling coarse aggregates for graduation, what is the minimum amount of aggregate needed for a #57 stone?



Slump Loss Testing

QUESTION:

When determining the slump loss of concrete for drilling shafts using the In-Place Method, what are the approximate dimensions of the hole or form work?



Rebound Hammer

QUESTION:

What is the minimum thickness of concrete members being tested by the Rebound Method?



Sampling Cement, Slag & Fly Ash

QUESTION:

What size sample is needed when sampling portland cement, slag, and fly ash?



ADDITIONAL INFORMATION

Batch Plant Inspection Considerations



Aggregates



Uneven Moisture Distribution in Stockpiles

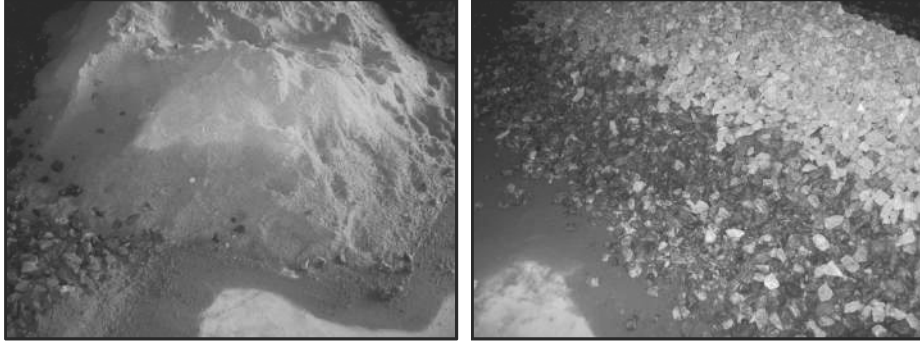

SCDOT

UNIVERSITY OF
South Carolina

Material Overrun in Stockpiles



SCDOT

UNIVERSITY OF
South Carolina

Cross Contamination of Materials



SCDOT

UNIVERSITY OF
South Carolina

Neat and Well Separated



SCDOT

UNIVERSITY OF
South Carolina

Truck Counter Locations

Where are they and are they working?



Truck Counter Locations

Where are they and are they working?



Truck Counter Locations

Where are they and are they working?

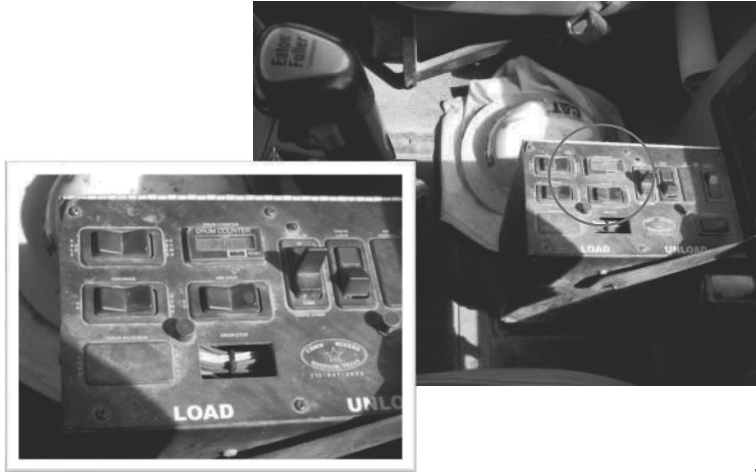

Truck Counter Locations

Where are they and are they working?



Mixer Rating Plates



SCDOT



Mixer Rating Plates... Where?



SCDOT



Mixer Rating Plates... Where?

Sometimes Located Inside Door



View of Admixture Bottles



Admixture Dispensers Must Be Visible to Batchman

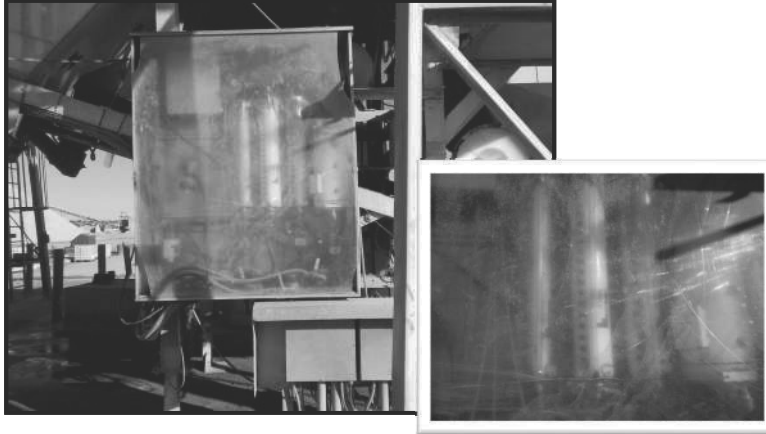

SCDOT

UNIVERSITY OF
South Carolina

Remote Cameras



Portable Plant Water



ADDITIONAL INFORMATION

Weather and Concrete

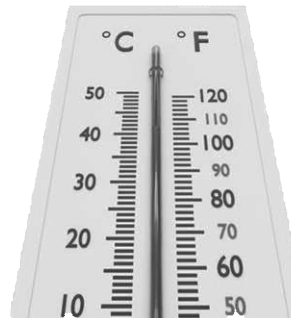
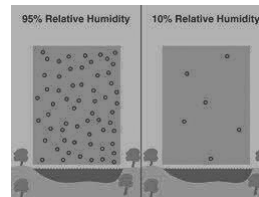

APPENDIX INFORMATION STANDARD SPECIFICATIONS

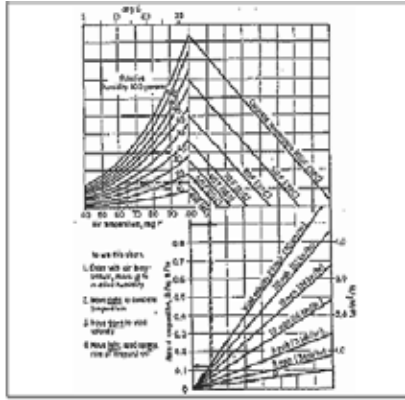

Nomograph for Determining Rate of Evaporation

This chart provides a graphic method of estimating the loss of surface moisture due to concrete and air temperatures, relative humidity, and wind velocity. To use the chart, follow the four steps outlined. If the rate of evaporation approaches 0.2 lbs/ft²/hr., precautions against plastic shrinkage cracking are necessary.



Moisture Loss in Concrete

What is a bridge deck?

- Large plate like structure
- Large amount of surface area

Where are they located?

- Generally over water and valleys
- Rivers and streams can form wind tunnels



Air Temperature

- Not Too Critical.
- All Other Things Equal,

**Going from 70° to 90°
Increases Water Loss by 10%**

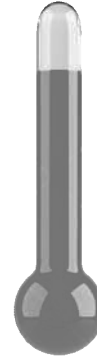

Humidity

- Not as Bad as You Might Think.
- All Other Things Equal,

**Going from 30% to 10% R.H.
Water Loss Up to 33%**

(10% R.H. Worse at 60° Than 90°)

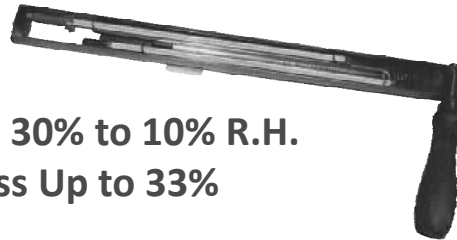

Concrete Temperature

- Very Critical.
- All Other Things Equal,

**Going from 70° to 90°
Increases Water Loss by 200%**



SCDOT

UNIVERSITY OF
South Carolina

Wind Velocity

- Most Critical
- All Other Things Equal,

**Going from a Wind Speed of 5 MPH to 25 MPH
Increases Water Loss by 375%**



SCDOT

UNIVERSITY OF
South Carolina

Evaporation of Surface Moisture

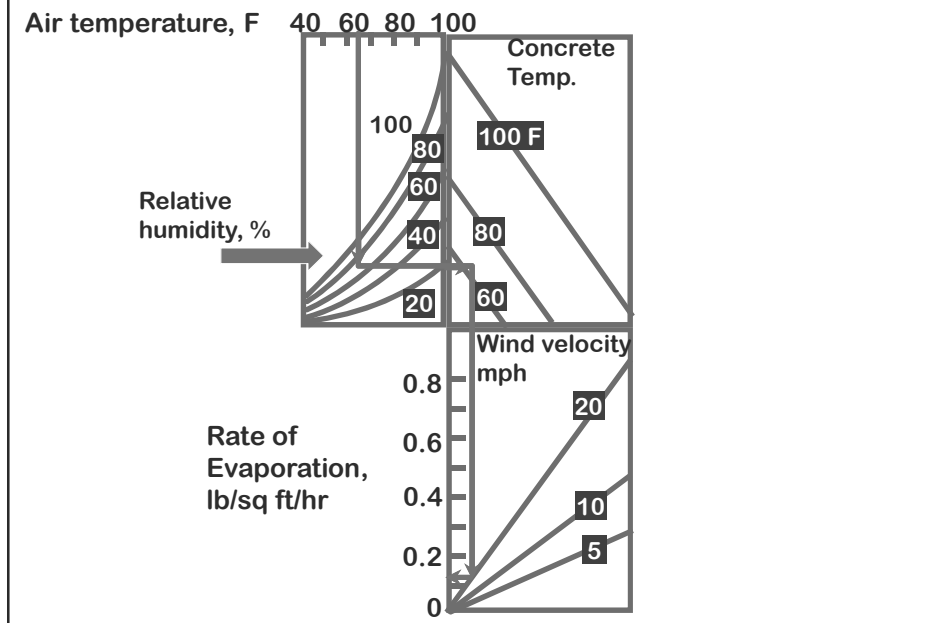

ORDERING CONCRETE

- Order at Least One Day in Advance
- Order the Proper Mix Design for the Job
- Check Delivery Ticket When Delivered



ADDING A GALLON OF WATER TO CONCRETE

- The slump is increased about 1”.
- The compressive strength is reduced by as much as 200 psi (@ day 28)
- The effect of about ¼ sack of cement is lost
- The possibility of moisture penetration through the concrete is increased
- The freeze-thaw resistance is reduced – scaling is increased
- The resistance to attack by deicing salt and commercial fertilizer is decreased – the possibility of scaling is increased.



Concrete Test Cylinders



Concrete Test Cylinders



Anything Wrong Here?



Maintain Cylinder Temperatures

Between 60 and 80°F & Hi Lo Thermometer are Required

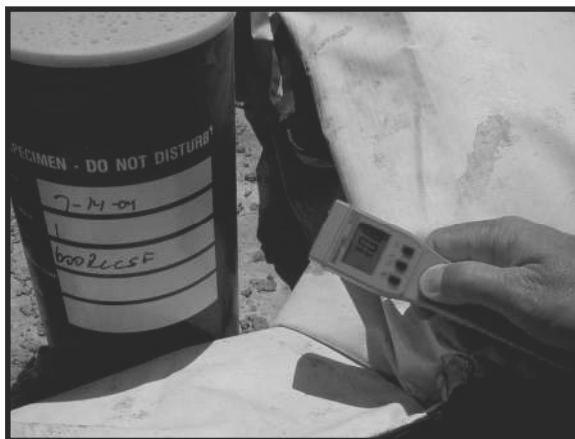

SCDOT

UNIVERSITY OF
South Carolina

Concrete Test Cylinders



SCDOT

UNIVERSITY OF
South Carolina

Sampling Cement and Fly Ash



Observation of Sample



Observation of Sample



SCDOT

UNIVERSITY OF
South Carolina

What slump was this Concrete?



Sampling Cement and Fly Ash

Do not sample material that has gone through any part of the concrete plant process.

- Contaminated samples can fail due to insoluble residue caused by sand particles or fly ash.

Sample from tanker when at all possible

- Remove top surface of material from tanker to avoid getting bag house fines
- Bag house fines can lead to sample failing due to finer material



YOU ARE THE FIELD INSPECTOR

- Document what you see.
- Report deviations from specifications.
- When possible, stop actions that will cause material failures or unacceptable products.
- Get proper samples and have them tested on required intervals.
- Sample materials that you feel are suspect.



**Standard Method of Test for
Methods of Sampling Coarse Aggregates
SCDOT Designation: SC-T-1 (9/16)**

1. SCOPE

- 1.1. These methods are intended to apply to coarse aggregates of gravel and crushed stone that have been sized and processed for use in construction items of work.
- 1.2. This standard may involve hazardous materials, operations and equipment. This standard does not purport to address all of the safety problems associated with its use. It is the responsibility of the user of this standard to consult and establish appropriate safety and health practices and determine the applicability of regulatory limitations prior to use.

2. SUMMARY OF TEST METHOD

- 2.1. A sample of coarse aggregate is obtained by combining portions taken from a conveyor belt, storage bin, stockpile, sample pad, or truck dump.

3. SIGNIFICANCE AND USE

- 3.1. Sampling is equally as important as the testing, and the sampler must use every precaution to obtain samples that will show the true nature and condition of the materials that they represent.

4. APPARATUS

- 4.1. Round or square point shovel, large sample bags, board (optional).

5. TEST SPECIMENS

- 5.1. The minimum size of sample shall conform to the requirements shown in Figure SC-T-1A.

6. PROCEDURE

- 6.1. *Sampling from Conveyor Belts* — Conveyor belts furnish a good point for sampling. It is necessary to stop the belt before taking a portion of the sample. Scrape clean at least 2 feet of the belt for the entire width and depth. Take at least three (3) portions from the belt and combine them into one sample. Allow the conveyor belt to make at least two (2) revolutions between the taking of each sample portion.
- 6.2. *Sampling from Storage Bins* — If samples are taken from a bin, take them from the entire cross-section of the flow of material as it is being discharged. At the beginning of

| Product Sampled | MINIMUM WEIGHT OF FIELD SAMPLES (pounds) |
|--|--|
| Coarse Aggregate (5, 57, 67, 789, etc.) | 40 |
| Aggregate Base (Macadam, MLBC, RPCC) | 70 |

TABLE OF MINIMUM SAMPLES SIZES
Figure SC-T-1A

the discharge from the bins, permit sufficient material to flow to insure normal uniformity before the sample is selected.

- 6.3. *Sampling from Stockpiles* — It is extremely difficult to obtain a representative sample of coarse aggregate from a stockpile and this method of sampling should be avoided whenever possible. When it is necessary to obtain samples from a stockpile, take a sample by combining approximately equal portions of materials taken from three (3) or more different locations with care being taken to avoid sampling a segregated area of coarse-grained material that is likely to exist at the base of the pile. The first portion should be obtained approximately three (3) feet above the base of the stockpile. The second portion should be obtained by moving diagonally across the loading face of the stockpile and approximately six (6) feet above the base of the pile. The third portion should be obtained by again moving diagonally across the loading face of the stockpile and approximately nine (9) feet above the base of the stockpile (see Figure SC-T-1B). If additional material is needed to make the minimum sample size requirement, take an additional portion from the middle sampling location. Before obtaining the material at each sampling point, remove the aggregate to a depth of 1 foot and then, with a round or square point shovel, obtain one shovel full from the bottom of the hole. Do not let pieces of aggregate fall off the shovel when transferring the material to the sample bag. To

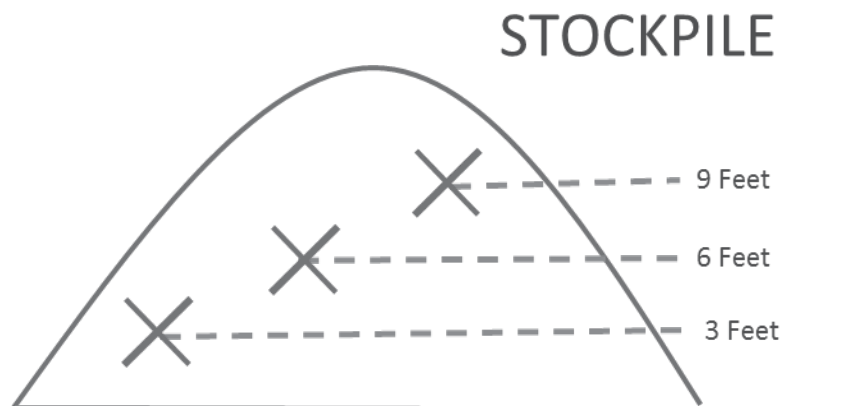

SAMPLING FROM STOCKPILES
Figure SC-T-1B

help in preventing further segregation during sampling, a board may be placed into the pile just above the point of sampling. The separate portions of material taken from three (3) different holes must be combined to form a composite sample.

- 6.4. *Sampling from Mini-stockpiles/ Sample Pads* – Whenever possible, take samples from a stockpile using the sample pad (also known as mini-stockpile) technique. To form a sample pad, the loader operator will take a minimum of two (2) buckets of material from the loading face of the large stockpile and place it onto the ground near the large stockpile by gently rolling the material out of the bucket. The loader operator should take care not to drop the material from any higher than necessary to prevent segregation of the material in the sample pad. The sample pad will then be struck off to approximately half its original height (about 15 to 18 inches) by back dragging with the loader bucket in the dumped position. As shown in Figure SC-T-1C, take the required amount of material for the sample from the exposed surface of the sample pad by sampling with a shovel taking care not to let material fall off of the shovel. Sample material by inserting the shovel vertically into the surface of the pad. Make sure the shovel is driven completely into the pad (but being careful not to remove any of the substrate material). Collect material from each of the four quadrants in order to obtain the minimum field sample size required for the type of aggregate being sampled. If additional material is needed to meet the minimum sample requirement, take additional portions from the center of the sample pad. Care should be taken to stay away from the edges of the pad where the material is subject to segregation.

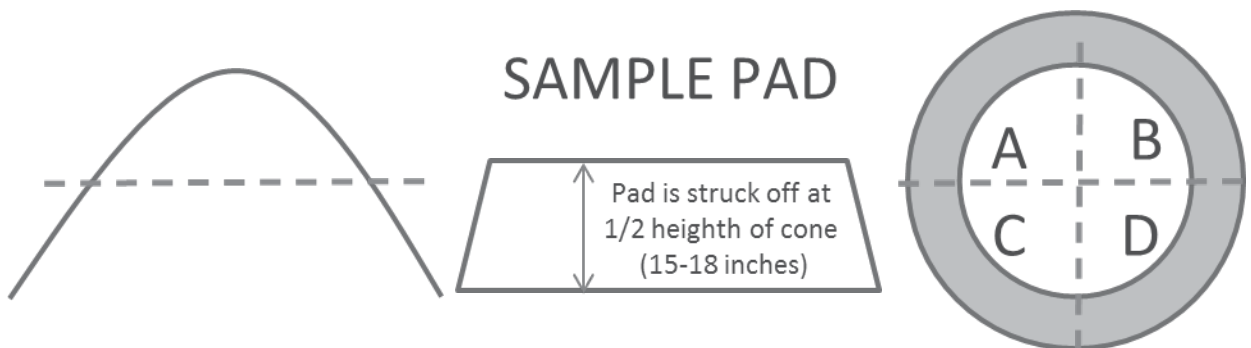

Sample from all 4 quadrants (A,B,C and D)

SAMPLING FROM A MINI-STOCKPILE/ SAMPLE PAD
Figure SC-T-1C

- 6.5. *Sampling from a Truck Dump.* Sampling from truck dumps should be avoided if possible. If a loader is available, then the truck dump should be remixed with the loader and struck off to form a sample pad that may be sampled by that procedure. If no other method is available and a truck dump must be sampled, obtain three (3) portions of material from locations across the truck dump, one portion from a front corner, one portion from the opposite back corner and one portion from the top of the dumped load (see Figure SC-T-1D). Before obtaining the material at each corner sampling point,

remove the aggregate to a depth of 1 foot and then, with a round or square point shovel, obtain one shovel full from the bottom of the hole. Do not let pieces of aggregate fall off the shovel when transferring the material to the sample bag. To help in preventing further segregation during sampling, a board may be placed into the pile just above the point of sampling. The separate portions of material taken from the three (3) different locations must be combined to form a composite sample. Take additional material from the center of the dumped load if required to meet the minimum sample size. Do not sample a truck dump after any material has been removed from that dumped load.

TRUCK DUMP

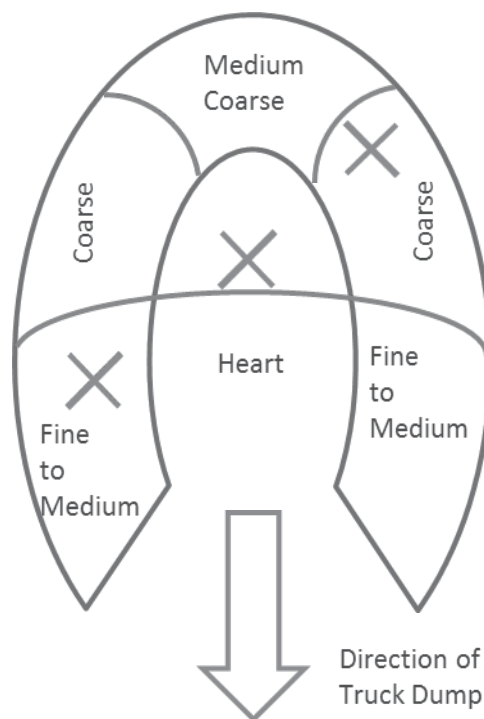

SAMPLING FROM A TRUCK DUMP
Figure SC-T-1D

- 6.6. *Sampling Graded Aggregate Base Materials from the Roadway:* Obtain Graded Aggregate Base samples after all mixing and shaping have been performed, but prior to initial compaction. Obtain three (3) portions of sample with a round or square point shovel at the station from which the sample is desired. Obtain one portion from the centerline and obtain the two remaining portions approximately two (2) feet from either edge of the base course. If the base material was placed with a joint at the centerline, then obtain that portion of the sample far enough off of the centerline that it does not come from the segregated area that may occur at the joint (See Figure SC-T-1E). Obtain portions for the full depth of the layer being sampled with care being taken not to contaminate the sample by going too deep and mixing subgrade soil with the base

material. A sampling ring may be used to help isolate the sampling area and prevent material from falling into the hole. Combine the three (3) portions to form a composite sample.

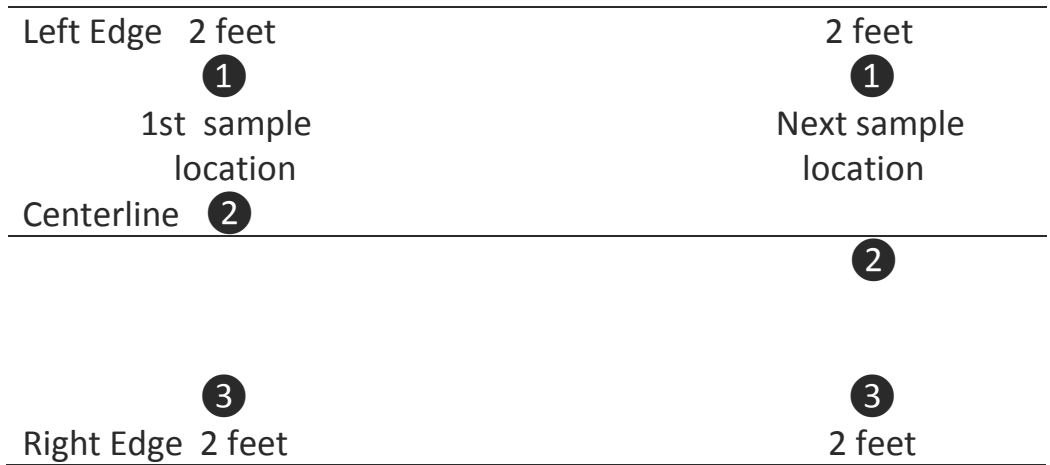

SAMPLING GRADED AGGREGATE BASE MATERIALS FROM THE ROADWAY
Figure SC-T-1E

**Standard Method of Test for
Methods of Sampling Fine Aggregates
SCDOT Designation: SC-T-2 (9/16)**

1. SCOPE

- 1.1. These methods are intended to apply to fine aggregates which have been produced for use in concrete or other construction items.
- 1.2. This standard may involve hazardous materials, operations and equipment. This standard does not purport to address all of the safety problems associated with its use. It is the responsibility of the user of this standard to consult and establish appropriate safety and health practices and determine the applicability of regulatory limitations prior to use.

2. SUMMARY OF TEST METHOD

- 2.1. A sample of fine aggregate is obtained by combining portions taken from a conveyor belt or stockpile.

3. SIGNIFICANCE AND USE

- 3.1. Sampling is equally as important as the testing, and the sampler must use every precaution to obtain samples that will show the true nature and condition of the materials that they represent.

4. APPARATUS

- 4.1. Depending on the location the sample is being taken: square or round point shovel, sampling tube, sample bags.

5. TEST SPECIMENS

- 5.1. The portions obtained as described below should be large enough to make a field sample of 20 pounds when combined or mixed and reduced as outlined in SC-T-3.

6. PROCEDURE

- 6.1. *Sampling from Conveyor Belts* — When sampling from a conveyor belt, it is very important that the inspector communicate with the plant personnel to be assured that the conveyor will not be activated while a portion of the sample is being obtained, thus causing possible injury to the sampler. Some conveyors may require a platform at the side to provide access for sampling. In the event a conveyor will not start again while it is loaded, some other method for obtaining a sample must be used.

- 6.1.1. Obtain at least three (3) approximately equal portions, selected at random, from the material being sampled. Stop the conveyor belt while each of the sample portions is being obtained. With scoop, trowel or other suitable tool, cut through the material at two (2) locations, thus separating the portion of material to be taken from the remaining material on the belt. Carefully scoop all material within the limits of the selected increment into a suitable container, making special effort to clean the belt of all the fines. After obtaining the three (3) or more portions, combine them to create a field sample as described in Section 5 of this procedure.

- 6.2. *Sampling from Stockpiles* — When sampling fine aggregate from a stockpile, select six (6) or more places around the stockpile to obtain the portions that will be combined to form the sample. At each sampling location, use care to shovel away the surface material to a point that moist material is exposed. With a shovel or sampling tube, obtain approximately equal portions from the six (6) or more locations. Combine the portions to form a composite sample that can be used to create a field sample as described in Section 5 of this procedure.

**Standard Method of Test for
Methods of Reducing Size of Aggregate Sample
SCDOT Designation: SC-T-3 (8/08)**

1. SCOPE

- 1.1. These methods are intended to apply to aggregate samples that have been obtained by the procedures outlined in SC-T-1 or SC-T-2.
- 1.2. This standard may involve hazardous materials, operations and equipment. This standard does not purport to address all of the safety problems associated with its use. It is the responsibility of the user of this standard to consult and establish appropriate safety and health practices and determine the applicability of regulatory limitations prior to use.

2. REFERENCED DOCUMENT

- 2.1. SC-T-1, SC-T-2.

3. SUMMARY OF TEST METHOD

- 3.1. A bulk sample of aggregate is reduced to the size necessary for testing by either the quartering method or the riffle splitter method.

4. SIGNIFICANCE AND USE

- 4.1. Sampling is equally as important as the testing, and the sampler must use every precaution to obtain samples that will show the true nature and condition of the materials that they represent. The sample size obtained during sampling is often larger than desirable for test procedures. Samples must be reduced in a manner that retains the properties of the original sample.

5. APPARATUS

- 5.1. For quartering method: clean and smooth surface free from cracks, shovel, trowel or other acceptable device for mixing aggregate and dividing the material. For riffle splitter method: riffle splitter pans to distribute material over splitter and catch material coming through splitter.

6. TEST SPECIMENS

- 6.1. The size of the test specimen required after reduction will be given in the procedure for that particular test.

7. PROCEDURE

7.1. Quartering Method:

- 7.1.1. Empty sample on a hard, clean and smooth surface that is free from cracks. Mix thoroughly and pile in a cone. Materials which tend to segregate should be dampened.
- 7.1.2. Flatten cone with a shovel, spreading the material to a circular layer of uniform thickness. Divide into quarters by two (2) lines intersecting at right angles at the center of the pile.
- 7.1.3. Discard the two (2) diagonally opposite quarters. Sweep clean the space occupied by the discarded quarters.
- 7.1.4. The remaining quarters should be thoroughly mixed and further reduced by quartering if desired. "Quartering" may be performed any number of times to obtain the required sample size.

7.2. Riffle Splitter Method:

- 7.2.1. The openings in the splitter device must be wide enough to let the largest particle easily pass through yet not so wide that a non-representative separation is obtained. (In general, the opening size should be approximately 50 percent greater than the largest particle size.)
- 7.2.2. Thoroughly mix the aggregate sample. Spread the material evenly across a rectangular pan having the proper width to allow equal portions of the material to be fed to each individual chute.
- 7.2.3. Dump the aggregate into the splitter device so that the sample is uniformly and simultaneously fed over the entire length of the splitter. Discard the material caught on one side of the splitter. This method of reducing a sample size may be repeated as many times as necessary to obtain the appropriate sample size.

**Standard Method of Test for
Procedure to Determine Aggregate Correction Factor Using
the Pressure Meter (ASTM C231)**

SCDOT Designation: SC-T-40 (11/15)

1. SCOPE

This test method covers the aggregate correction factor to determine the actual percent air in a pre-approved mix design.

2. REFERENCED DOCUMENTS

ASTM C231

3. PROCEDURE

- 3.1 Obtain samples of fine and coarse aggregates from the same sources shown on the pre-approved mix design.
- 3.2 Oven dry aggregates and let cool.
- 3.3 Compute the weight of fine and coarse aggregates to fill the 0.25 cubic foot pressure meter pot. The fine to coarse aggregate ratio must be the same as the mix design.
- 3.4 Place a small amount of water in pot and place all fine aggregate in pressure meter pot followed by additional water if needed to completely cover fine aggregate. Stir and tap the sides of the pot to remove any entrapped air. Keep fine aggregate covered with water.
- 3.5 Gradually place scoopfuls of coarse aggregate in pressure meter pot keeping aggregate covered with water. Remove any foam that may be present. Lightly rod the upper 1" of the aggregate eight to twelve times. Stir after each addition of aggregate to eliminate entrapped air.
- 3.6 Keep aggregate covered with water.
- 3.7 Place short tube in bottom of top section of pressure meter lid and mark the petcock on top of the meter lid that the tube is attached. Clamp top of pressure meter lid to pot.
- 3.8 Ensure entrapped air is removed by filling the pressure meter with water in the petcock with the short tube until a steady stream of water is visible. Gently tap meter to ensure all entrapped air has been released.

- 3.9 Pump pressure to the pre-determined initial pressure.
- 3.10 Close petcocks.
- 3.11 Place curved tube on petcock with the short tube.
- 3.12 Bleed off 5% of water using the calibrated vessel.
- 3.13 Release pressure, rerun and determine new percent.

**Standard Method of Test for
Slump Loss of Portland Cement Concrete**
SCDOT Designation: SC-T-45 (09/09)

1. SCOPE

- 1.1. To determine the slump loss of freshly mixed Portland Cement Concrete over a period of time.
- 1.2. This method is typically used for drilled shaft concrete. It may also be applicable in special circumstances as deemed necessary by the RCE.
- 1.3. The purpose of this test is to ensure that drilled shaft concrete has a slump within the range specified in Subsection 701.2.12.3 of the 2007 edition of SCDOT's Standard Specifications For Highway Construction when placed and maintains a minimum slump as specified in Subsection 712.4.13.2 of the 2007 edition of SCDOT's Standard Specifications For Highway Construction.

2. REFERENCED DOCUMENTS

ASTM C172 - Sampling Freshly Mixed Concrete

ASTM C143 - Slump of Hydraulic-Cement Concrete

ASTM C1064 -Temperature of Freshly Mixed Hydraulic-Cement Concrete

ASTM C231 - Air Content of Freshly Mixed Concrete by the Pressure Meter (if required)

ASTM C31 - Making and Curing Test Specimens in the Field (if required)

3. PROCEDURE

- 3.1 Perform the test on concrete intended for use in the final product and meeting all applicable SCDOT specifications.
- 3.2 Prepare the approved mix for the slump loss test at a temperature consistent with ambient and concrete temperatures expected during actual concrete placement.
- 3.3 Ensure that the test batch is a minimum of 3 cubic yards.
- 3.4 After the test batch has been mixed according to Division 700 requirements, perform initial slump (ASTM C143), ambient and concrete temperatures (ASTM C1064), and if air entrained, air content (ASTM C231).
- 3.5 Part A In-Place Concrete
 - 3.5.1 To simulate in-place plastic concrete, discharge approximately 1 cubic yard of test batched concrete in a hole or form having approximate dimensions of 3 feet x 3 feet x 3 feet lined with plastic to prevent moisture loss through the ground or forms. Have enough plastic to cover the top of the hole or form to prevent rapid evaporation.

3.5.2 Isolate the concrete from vibration for the duration of the test.

3.5.3 Obtain concrete from the simulated in-place concrete and perform slump every hour until slump has reached the specified minimum in-place slump. Recover the simulated in-place concrete with plastic after each slump test.

3.6 Part B Mixer Truck

3.6.1 Discharge approximately 1 cubic foot of test batch concrete and perform slump, ambient and concrete temperature and air content (if air-entrained) every 30 minutes (\pm 5 minutes) until slump has reached the minimum allowable level or the designated time frame has expired (use 2 hours unless otherwise specified by the RCE), whichever comes first.

3.6.2 After performing the initial tests, slowly agitate the mixer drum just prior to performing the next set of tests. Mix the test batch concrete for at least one minute at mixing speed.

4. REPORT

4.1. Record all results on SCDOT's Slump Loss Report, OMR Form 712.1

Rev 9/4/09

Standard Practice for
Making and Curing Concrete Beam Specimens
SCDOT Designation: SC-T-46

1. SCOPE

- 1.1. This practice covers procedures for making beam specimens from representative samples of fresh concrete for a construction project. The nominal size of the beam specimen is 6 inches by 6 inches by 20 inches.
- 1.2. This practice is not satisfactory for making specimens from concrete not having measurable slump or requiring other shapes and sizes.
- 1.3. This standard may involve hazardous materials, operations, and equipment. This standard does not purport to address all of the safety problems associated with its use. It is the responsibility of the user of this standard to consult and establish appropriate safety and health practices and determine the applicability of regulatory limitations prior to use.

2. REFERENCED DOCUMENTS

- 2.1. None.

3. SIGNIFICANCE AND USE

- 3.1. This practice provides standardized requirements for making concrete beam specimens.
- 3.2. If the specimens are made and standard cured, as stipulated herein, the resulting strength test data when the specimens are tested are able to be used for the following purposes:
 - 3.2.1. Acceptance testing for specified strength,
 - 3.2.2. Checking adequacy of mixture proportions for strength,
 - 3.2.3. Quality control.
- 3.3. Sampling is equally as important as the testing, and the sampler must use every precaution to obtain samples that will show the true nature and condition of the materials that they represent.

4. APPARATUS

- 4.1. *Beam Molds* — Beam molds shall be of the shape and dimensions stipulated in step 5.1. The inside surfaces of the molds shall be smooth. The sides, bottom and ends shall be at right angles to each other and be straight and true and free of warpage. Maximum variation from the nominal cross section shall not exceed 1/8 inch. Molds shall produce

specimens at least as long but not more than 1/16 inch shorter than the required length in step 5.1.

- 4.2. *Tamping Rod* — A round, straight steel rod that is 5/8 inches in diameter and 20 inches in length, having the tamping end or both ends rounded to a hemispherical tip of the same diameter as the rod.
- 4.3. *Vibrators* — Internal vibrators shall be used. The vibrator frequency shall be at least 7000 vibrations per minute (150 Hz) while the vibrator is operating in the concrete. The diameter of a round vibrator shall be no more than 1.5 inches. Other shaped vibrators shall have a perimeter no greater than the equivalent round vibrator (1.77 inches). The combined length of the vibrator shaft and vibrating element shall be at least 9 inches. The vibrator frequency shall be checked periodically using the vibrating reed tachometer.
- 4.4. *Mallet* — A mallet with a rubber or rawhide head weighing 1.25 ± 0.50 pounds shall be used.
- 4.5. *Small Tools* — Shovels, hand-held floats, scoops, and vibrating reed tachometer shall be provided.
- 4.6. *Sampling Receptacle* — The receptacle shall be a suitable heavy gage metal pan, wheelbarrow, or flat, clean, nonabsorbent board of sufficient capacity to allow easy remixing of the entire sample with a shovel or trowel.

5. TESTING REQUIREMENTS

- 5.1. *Beam Specimens* — Flexural strength specimens shall be beams of concrete cast and hardened in the horizontal position. The standard beam shall be 6 by 6 inches in cross section and 20 inches in length.

6. SAMPLING CONCRETE

- 6.1. The samples used to fabricate test specimens under this standard shall be obtained in accordance with SCDOT procedure SC-T-41, "Sampling Fresh Concrete".

7. MOLDING SPECIMENS

- 7.1. *Place of Molding* — Mold specimens promptly on a level, rigid surface, free of vibration and other disturbances, at a place as near as practicable to the location where they are to be stored.
- 7.2. *Consolidation* — The methods of consolidation for this practice are rodding or internal vibration.
 - 7.2.1. *Rodding* — Place the concrete in the mold, in two layers of approximately equal depth. Rod each layer with the rounded end of the rod sixty (60) times, distributing the roddings uniformly over the cross section of the mold. For the upper layer, allow the rod to penetrate through the layer being rodded into the layer below approximately 1 inch.

After each layer is rodded, tap the outsides of the mold lightly 10 to 15 times with the mallet, to close any holes left by rodding and to release any large air bubbles that may have been trapped. (*Note: Do NOT use a steel hammer for this step.*) After tapping, spade each layer of the concrete along the sides and ends of beam molds with a trowel or other suitable tool. It is recommended that the mold be slightly overfilled for the second layer prior to rodding to account for the reduction of volume caused by consolidation. Underfilled molds shall be adjusted with representative concrete during consolidation of the top layer. Overfilled molds shall have excess concrete removed.

- 7.2.2. *Vibration* — Maintain a uniform duration of vibration for the particular kind of concrete and vibrator involved. Fill each mold so as to avoid overfilling (after vibration) by more than $\frac{1}{4}$ inch. Only one layer of concrete is required. Vibrate once in the center of the mold and once at each end, 6 inches from the center. Vibrate long enough only to achieve proper consolidation of the concrete. Usually sufficient vibration has been applied as soon as the surface of the concrete the surface of the specimen has become relatively smooth. While vibrating the specimen, the vibrator shall not be allowed to rest on or touch the sides or bottom of the mold. Carefully withdraw the vibrator in such a manner that no air pockets are left in the specimen. After vibration, tap the outsides of the mold at least 10 times with the mallet to close holes that remain and release entrapped air voids. (*Note: Do NOT use a steel hammer for this step.*)
- 7.3. *Finishing* — After consolidation, finish the specimen by striking off the top with a straightedge and finishing with a hand-held float. Overfinishing shall be avoided. Care should be taken to when cutting down the specimen to avoid removal of excess depth. (*Note: This can be accomplished with a straightedge that has a sharp side corner rather than a worn or rounded side corner.*) Smooth the surface with a flat trowel.

8. CURING

- 8.1. *Storage* — If specimens cannot be molded at the place where they will receive initial curing, immediately after finishing move the specimens to an initial curing place for storage. The supporting surface on which specimens are stored shall be level to within 0.25 inch per foot.
- 8.2. *Initial Curing* — Immediately after molding and finishing, the specimens shall be stored for a period between 18 and 48 hours in a temperature range of 60°F to 80°F and in an environment preventing moisture loss from the specimens. Various procedures are capable of being used during the initial curing period to maintain the specified moisture and temperature conditions. An appropriate procedure or combination of procedures shall be used (See Note 3). Shield all specimens from direct sunlight and, if used, radiant heating devices. The storage temperature shall be controlled by the use of heating and cooling devices, as necessary. Record the temperature using a maximum-minimum thermometer. (*Note 3: A satisfactory moisture environment can be created during the initial curing by one or more of the following procedures: (1) place inside plastic bags, (2) cover with plastic sheets or non-absorbent, non-reactive plates or a sheet of tough, durable plastic. A satisfactory temperature environment can be controlled during the initial curing of the specimens by one or more of the following*

procedures: (1) use of ventilation, (2) use of ice, (3) use of thermostatically controlled heating or curing devices, or (4) use of heating methods such as stoves or light bulbs. Other suitable methods may be used provide the requirements limiting specimen storage temperature and moisture loss are met.)

- 8.3. *Final Curing* — Upon completion of initial curing and within 30 minutes after removal the molds, cure specimens with free water maintained on their surfaces at all times at a temperature of $73^{\circ} \pm 3^{\circ}\text{F}$ through the use of an approved moist curing room or in a continuously circulating, thermostatically temperature-controlled bath of water saturated with calcium hydroxide. Upon removal from the molds, the specimens shall be marked with a waterproof felt tip marker to minimally indicate month, day, and specimen number. Care shall be exercised in handling the beams to avoid bumping them together or dropping them. A recording thermometer shall be used to monitor air or water temperature, as appropriate, to create a permanent record of curing temperature. If a moist curing room is used, the specimens shall be stored in a calcium hydroxide-saturated water bath meeting the requirements given above for a minimum of 20 hours prior to testing. Drying of the surfaces of the beam shall be prevented between removal from water storage and completion of testing. *(Note 4: Relatively small amounts of surface drying of flexural specimens can induce tensile stresses in the extreme fibers that will markedly reduce the indicated flexural strength.)*

9. TRANSPORTATION OF SPECIMENS TO LABORATORY

- 9.1. If the specimens must be transported for final testing, cure and protect specimens as required in Step 8. Specimens shall not be transported until they are at least 7 days old. When transporting specimens, a truck bed covered with damp sand or several layers of dampened burlap shall be used in order to keep the surfaces damp while transporting. After placing beams in the prepared truck bed, a polyethylene cover should be used to hold moisture in the load while traveling. Under no circumstances shall the transportation time exceed 4 hours.

Standard Method of Test for

Method of Sampling Portland Cement, Slag, and Fly Ash

SCDOT Designation SC-T-47 (8/08)

1. SCOPE

- 1.1. These methods cover the procedures for sampling Portland Cement, Slag, and Fly Ash.

2. SUMMARY OF SAMPLING METHOD

- 2.1. A sample of Portland Cement may be sampled from a bulk shipment of car or truck, or from the batch plant silo.

3. SIGNIFICANCE AND USE

- 3.1. Sampling is equally as important as the testing, and the sampler must use every precaution to obtain samples that will show the true nature and condition of the materials that they represent.

4. APPARATUS

- 4.1. Plastic airtight gallon container and a suitable, clean, shoveling device

5. TEST SPECIMENS

- 5.1. *Sample size and sample protection* – The size of the sample of material shall be 4 quarts. As samples are taken, they shall be placed directly in moisture-proof, airtight, containers to avoid moisture absorption and aeration of the sample. Containers shall be completely filled and sealed immediately.

6. PROCEDURE

- 6.1. *Sampling* – The material may be sampled as circumstances and batch plant equipment permit. In all cases, care shall be taken to prevent contaminating the sample by foreign matter. In most cases, samples may be obtained as follows:
 - 6.1.1. *From Bulk Shipment of Rail Car or Truck* – The sample may be obtained from the delivery vehicle or along the conveyer route of travel from the vehicle to the batch plant storage silo. When sampling from the delivery vehicle, the sample may be obtained from the top hatch openings of a full load. The sample shall be taken at different points and should not include the surface material. When sampling from the conveyor route, be it bucket, auger, or air flow, the sample shall be obtained by stopping the conveyor as many times as is necessary to obtain a complete sample.
 - 6.1.2. *From Batch Plant Silo* – The sample may be obtained from the scale hopper or by discharge as equipment will permit. Sampling from batch plant silos should only be done as a last resort when the identity of the material sample by mill test report is questionable.

Standard Method of Test for Determining the Rebound Number of Hardened Concrete

SCDOT Designation: SC-T-49 (6/14)

1. SCOPE

This test method covers the determination of a rebound number of hardened concrete using a spring-driven steel hammer. The values stated in SI units are to be regarded as the standard. This standard does not purport to address all of the safety concerns, if any, associated with its use. It is the responsibility of the user of this standard to establish appropriate safety and health practices and determine the applicability of regulatory limitations prior to use.

2. REFERENCED DOCUMENTS

- 2.1 ASTM C805 Standard Test Method for Rebound Hammer of Hardened Concrete

3. SUMMARY OF TEST METHOD

- 3.1 A steel hammer impacts with a predetermined amount of energy, a steel plunger in contact with a surface of concrete, and the distance that the hammer rebounds is measured.

4. SIGNIFICANCE AND USE

- 4.1 This test method may be used to assess the in-place uniformity of concrete, to delineate regions in a structure of poor quality or deteriorated concrete, and to estimate in-place strength development.
- 4.2 To use this test method to estimate strength requires establishing a relationship between strength and rebound number. The relationship shall be established for a given concrete mixture and given apparatus. The relationship shall be established over the range of concrete strength that is of interest. To estimate strength during construction, establish the relationship by performing rebound number tests on molded specimens and measuring the strength of the same or companion molded specimens. To estimate strength in an existing structure, establish the relationship by correlating rebound numbers measured on the structure with the strengths of cores taken from corresponding locations.
- 4.3 For a given concrete mixture, the rebound number is affected by factors such as moisture content of the test surface, the method used to obtain the test surface (type of form material or type of finishing), and the depth of carbonation. These factors need to be considered in preparing the strength relationship and interpreting test results.

5. APPARATUS

- 5.1 Rebound Hammer, consisting of a spring-loaded steel hammer which when released strikes a steel plunger in contact with the concrete surface. The spring-loaded hammer must travel with a consistent and reproducible velocity. The rebound distance of the steel hammer from the steel plunger is measured on a linear scale attached to the frame of the instrument.

NOTE 1 - Several types and sizes of rebound hammers are commercially available to accommodate testing of various sizes and types of concrete construction.

- 5.2 Abrasive Stone, consisting of medium-grain texture silicon carbide or equivalent material.
- 5.3 Verification anvil, used to check the operation of the rebound hammer. An instrument guide is provided to center the rebound hammer over impact area and keep the instrument perpendicular to the anvil surface. The anvil shall be constructed so that it will result in a rebound number of at least 75 for a properly operating instrument.

NOTE 2 - A suitable anvil has included an approximately 150-mm (6-in.) diameter by 150-mm (6-in) tall steel cylinder with an impact area hardened to an HRC hardness value 64 to 68.

6. TEST AREA

- 6.1 Selection of Test Surface—Concrete members to be tested shall be at least 100 mm (4 in.) thick and fixed within a structure. Smaller specimens must be rigidly supported. Areas exhibiting honeycombing, scaling, or high porosity should be avoided. Troweled surfaces generally exhibit higher rebound numbers than screeded or formed finishes. If possible, structural slabs should be tested from the underside to avoid finished surfaces.
- 6.2 Preparation of Test Surface—A test area shall be at least 150 mm (6 in.) in diameter. Heavily textured, soft, or surfaces with loose mortar shall be ground smooth with the abrasive stone described in 5.2 Smooth-formed or troweled surfaces do not have to be ground prior to testing.
- 6.2.1 Ground and unground surfaces should not be compared.
- 6.3 Other factors that may affect the results of the test are as follows:
- 6.3.1. Concrete at 0°C (32°F) or less may exhibit very high rebound values. Concrete should be tested only after it has thawed.
- 6.3.2. The temperatures of the rebound hammer itself may affect the rebound number.

NOTE 3 - Rebound hammers at -18°C (0°F) may exhibit rebound numbers reduced by as much as 2 or 3.

- 6.3.3. For readings to be compared the direction of impact, horizontal, downward, upward, etc., must be the same or established correction factors shall be applied to the readings.
- 6.3.4. Do not conduct tests directly over reinforcing bars with cover less than 20 mm (0.75 in.)
- 6.3.5. Different hammers of the same nominal design may give rebound numbers differing from 1 to 3 units and therefore, tests should be made with the same hammer in order to compare results. If more than one hammer is to be used, a sufficient number of tests must be made on typical concrete surfaces so as to determine the magnitude of the differences to be expected.
- 6.3.6. Rebound hammers shall be serviced and verified semiannually and whenever there is reason to question their proper operation. Test anvils described in 5.3 are recommended for verification.

NOTE 4 - Typically, a properly operating rebound hammer and a properly designed anvil should result in a rebound number of about 80. Verification on an anvil will not guarantee that the hammer will yield repeatable data at other points on the scale. Some users compare the usual range of rebound numbers encountered in the field.

7. PROCEDURE

- 7.1 Hold the instrument firmly so that the plunger is perpendicular to the test surface. Gradually push the instrument toward the test surface until the hammer impacts. After impact, maintain pressure on the instrument and, if necessary, depress the button on the side of the instrument to lock the plunger in its retracted position. Read the rebound number on the scale to the nearest whole number and record the rebound number. Take 10 readings from each test area. No two-impact points shall be closer together than 25 mm (1 in.) and the distance between impact points and edges of the member shall be at least 50 mm (2 in). Examine the impression made on the surface after impact, and if the impact crushes or breaks through a near-surface air void disregard the reading and take another reading.

8. CALCULATION

- 8.1 Discard readings differing from the average of 10 readings by more than 6 units and determine the average of the remaining readings. If more than 2 readings differ from the average by 6 units, discard the entire set of readings and determine rebound numbers at 10 new locations within the test area. If readings appear to be erroneous due to extremely high or extremely low rebound numbers, discard these readings without recording them. Extreme high and low readings are generally due to air-voids, steel reinforcement, or coarse aggregates close to the surface. The average rebound number can then be applied to the proper rebound number chart to get an estimated compressive strength.

9. REPORT

None.

Note: A letter is typically sent to the RCE with the following information.

- *Date*
- *Identification of location tested*
- *Design strength of concrete tested*
- *Hammer identification*
- *Orientation of hammer during test*
- *Average rebound number*
- *Strength, PSI (MPa)*
- *Remarks regarding unusual conditions*

File No. _____
 Project No. _____
 Charge Code _____
 Hammer No. _____
 Date _____

Person(s) Present for Test

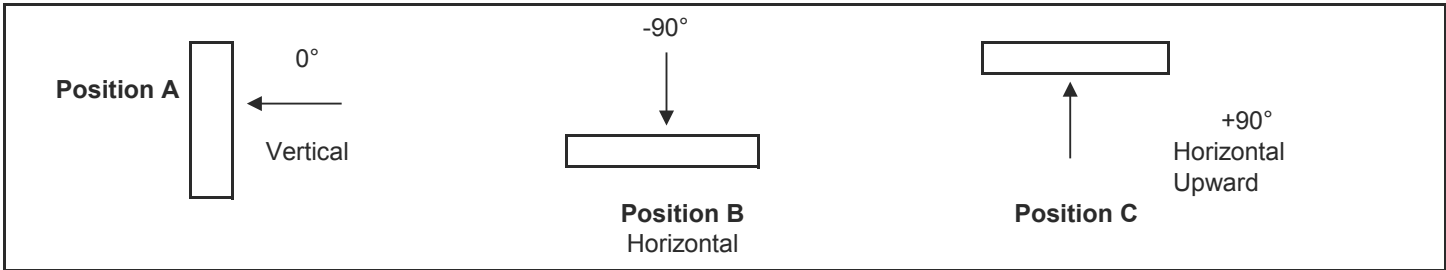

Cylinder Lab No. _____ Station or ID _____
 Date cylinder made _____ Cylinder strength _____ Age _____
 Cylinder ID _____ Concrete surface condition _____

READINGS

| | | | | |
|-------------|---------------|---------|-----------------|----------|
| 1 _____ | 4 _____ | 7 _____ | 10 _____ | Position |
| 2 _____ | 5 _____ | 8 _____ | _____ | |
| 3 _____ | 6 _____ | 9 _____ | _____ | |
| Total _____ | Avg. of _____ | | Chart PSI _____ | |

Mean error _____ ± 6 Reading Range _____

Cylinder Lab No. _____ Station or ID _____
 Date cylinder made _____ Cylinder strength _____ Age _____
 Cylinder ID _____ Concrete surface condition _____

READINGS

| | | | | |
|-------------|---------------|---------|-----------------|----------|
| 1 _____ | 4 _____ | 7 _____ | 10 _____ | Position |
| 2 _____ | 5 _____ | 8 _____ | _____ | |
| 3 _____ | 6 _____ | 9 _____ | _____ | |
| Total _____ | Avg. of _____ | | Chart PSI _____ | |

Mean error _____ ± 6 Reading Range _____

Cylinder Lab No. _____ Station or ID _____
 Date cylinder made _____ Cylinder strength _____ Age _____
 Cylinder ID _____ Concrete surface condition _____

READINGS

| | | | | |
|-------------|---------------|---------|-----------------|----------|
| 1 _____ | 4 _____ | 7 _____ | 10 _____ | Position |
| 2 _____ | 5 _____ | 8 _____ | _____ | |
| 3 _____ | 6 _____ | 9 _____ | _____ | |
| Total _____ | Avg. of _____ | | Chart PSI _____ | |

Mean error _____ ± 6 Reading Range _____

Remarks _____

CHAPTER 12

Math

This chapter contains example math problems typical of those inspectors will encounter on a daily basis. These exercises are presented as word problems with associated figures. A detailed solution for each problem is provided at the end of the chapter.

Some of the concepts covered are:

- **Unit Conversion**
- **Volume Calculations**
- **Area and Surface Area Calculations**
- **The Relationship between Density, Mass and Volume**
- **Solving Single Variable Algebraic Equations**
- **Conversion Factors**
- **Geometry Equations**
 - Perimeter
 - Circumference
 - Area
 - Volume

Space has been provided for the student to answer each question. Keep in mind that there are many different ways to obtain the same answer. The solutions provided may differ from the techniques used by others. The goal is to obtain the same answer, regardless of the methods used.

Useful Formulas

Perimeter of a rectangle: $(2 \times L) + (2 \times W)$

Area of a rectangle: $L \times W$

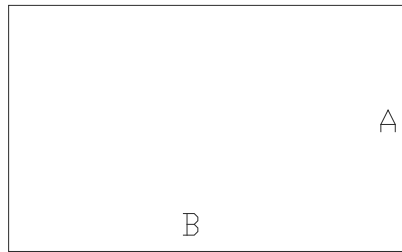

Q1.1

For the rectangle shown, what is the perimeter in yards if $A=1$ mile and $B=126,720$ inches?

Q1.2

What is the area of the rectangle in square feet (sqft) if $A=60$ yards and $B=300$ feet?

Q1.3

If the area of the rectangle is $14,000 \text{ yd}^2$ and the width at $A=210$ feet, what is the length of side B in yards?

Q1.4

If the area of the rectangle is $1,080 \text{ in}^2$ and the length $A=1$ yard, what is the width of side B in feet?

Useful Formulas

Circumference of a circle: $2\pi r$

Area of a circle: πr^2

Diameter of a circle: 2 x radius

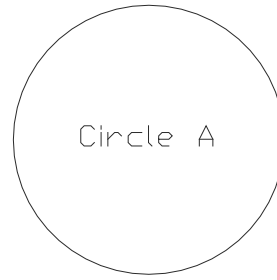

Q2.1

If the diameter of circle A is 8 inches, what is the radius of circle A? What is the circumference of circle A?

Q2.2

If the radius of circle A is 9 inches, what is the diameter in feet?

Q2.3

What is the area of circle A in square inches if the radius is 15 inches? What would the area be in square feet?

Q2.4

If the area of circle A is 4.9 yd^2 , what is the circle's diameter in feet?

Q2.5

If a circle has a circumference of 7.33 yards, what is its area in square feet?

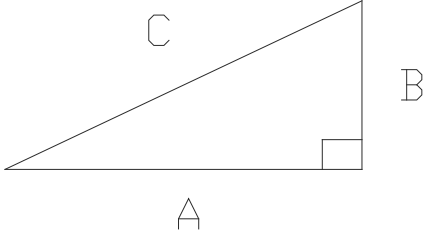
| | |
|--|--|
| <p>Useful Formulas</p> <p>Perimeter of a triangle: $A+B+C$</p> <p>To find the unknown length of a right triangle's side: $A^2+B^2=C^2$</p> <p>Area of a triangle: $\frac{1}{2}$ base x height</p> |  |
|--|--|

Q3.1

What is the area of the right triangle shown, in square feet if leg B is 96 inches long and leg A is 5 yards long?

Q3.2

What is the height of a right triangle, if leg A is 75 feet and hypotenuse C is 110 feet?

Q3.3

What is the length of leg A in feet (to one decimal place), if leg B is 5 feet and C is 7.1 feet? What is the triangle's area in square feet?

Q3.4

For the right triangle shown, what is the area in square feet if $A=8'$ and $C=10'$? What is the area in square yards?

Useful Formulas

Perimeter of a rectangle: $(2 \times L) + (2 \times W)$

Area of a rectangle: $L \times W$

Volume of a cube:

Length \times Width \times Height

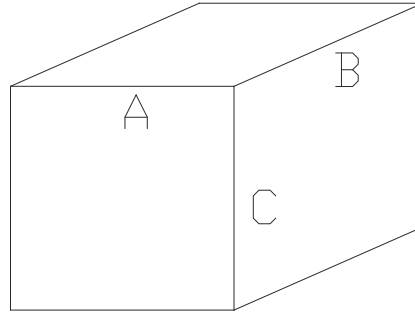

Q4.1

For the cube shown, what is the volume (to one decimal place) in cubic yards if $A=6\text{ft}$, $B=8\text{ft}$ and $C=2\text{yd}$?

Q4.2

If the cube shown has a density of 150 lbs/cubic foot, use the volume determined in Q4.1 to determine the solid's weight.

Q4.3

If a cubic structure weighs 2.2 tons and has a density of 200 lbs/cubic foot, what is the length of side "C" in inches if side "B" is 6 feet and side "A" is 30 inches?

Useful Formulas

Perimeter of a rectangle: $(2 \times L) + (2 \times W)$

Area of a rectangle: $L \times W$

Volume of a cube:

Length \times Width \times Height

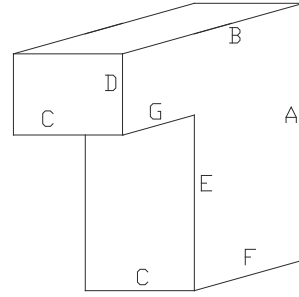

Q5.1

What is the volume of the figure shown if length $C=F=G=1$ ft, $D=6$ inches and $E=2$ ft?

Q5.2

Using the volume calculated in Q5.1, what is the density of this structure if it weighs 175 pounds?

Useful Formulas

Perimeter of a rectangle:

$$(2 \times L) + (2 \times W)$$

Area of a rectangle: $L \times W$

Volume of a cube:

$$\text{Length} \times \text{Width} \times \text{Height}$$

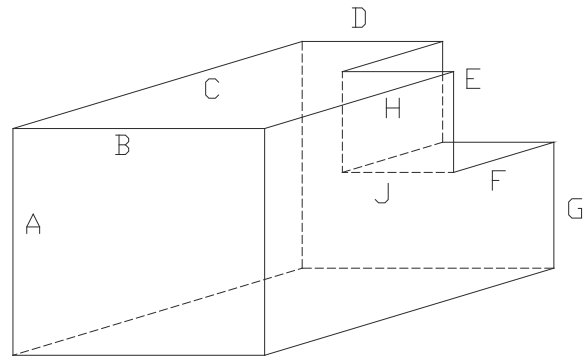

Q6.1

What is the length of side D in inches if $A = 1\text{yd}$, $B = 1.5\text{yd}$, $C = 5\text{ft}$ and $E = F = J = 18\text{ inches}$?

Q6.2

What is the length of side G in inches using the lengths given in Q6.1?

Q6.3

What is the length of side H in inches using the lengths given in Q6.1?

Q6.4

If cube ABC had a volume of 67.5 ft^3 prior to removing corner EFJ, how much does the structure weigh (in pounds) after removing corner EFJ given a density of 140 lbs/ft^3 ?

Useful Formulas

Circumference of a circle: $2\pi r$

Area of a circle: πr^2

Diameter of a circle: 2 x radius

Volume of a cylinder: $\pi r^2 \times \text{length}$

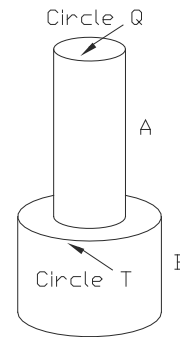

Q7.1

What is the length of cylinder AQ in feet if the area of circle Q is 1018 square inches and the volume of cylinder AQ is 146,592 in³?

Q7.2

What is the radius of circle T if the volume of cylinder BT is 904.8 ft³ and B is 96 inches tall?

Q7.3

Using the volumes from Q7.1 and Q7.2, determine the weight in pounds of the figure AQ~BT if the material density is 3800 lb/yd³.

Useful Formulas

Circumference of a circle: $2\pi r$

Area of a circle: πr^2

Diameter of a circle: 2 x radius

Volume of a cylinder: $\pi r^2 \times \text{length}$

Area of a rectangle: L x W

Volume of a cube:

Length x Width x Length

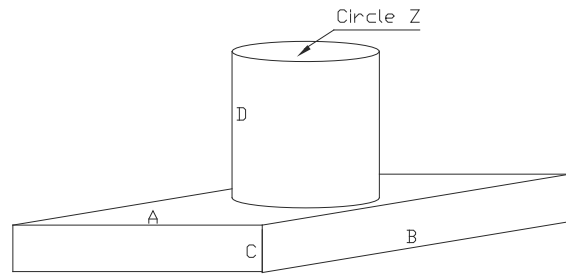

Q8.1

If "Circle Z" has a circumference of 300 inches, what is the diameter of circle Z to the nearest inch?

Q8.2

If the ratio of lengths A:B:D is 1.5:2:1, and cylinder "DZ" has a volume of 50.24ft³ with a radius of 24 inches, then what lengths are cube sides "A" and "B"?

Useful Formulas

Area of a rectangle: $L \times W$

Surface Area = Sum of all face areas

Volume of a triangular pyramid:

$$\frac{1}{2} \text{ base} \times \text{height} \times \text{length}$$

To find the unknown length of a right triangle's side: $A^2 + B^2 = C^2$

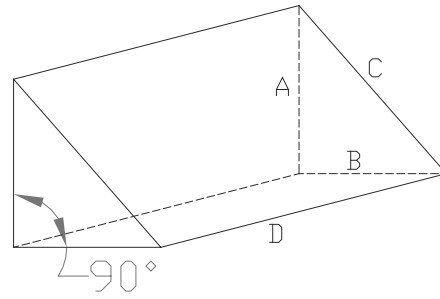

Q9.1

For the structure shown, determine the surface area in square feet if $A = 5.5\text{in}$, $B = 7.1\text{in}$ and $D = 22\text{in}$.

Q9.2

Using the dimensions from Q9.1 determine the volume of this structure in gallons. One gallon contains 231in^3 .

Useful Formulas

To find the unknown length of a right triangle's side: $A^2+B^2=C^2$

Area of a triangle: $\frac{1}{2}$ base x height

Volume of a cube: L x W x H

Volume of a triangular pyramid:

$$\frac{1}{2} \text{ base x height x length}$$

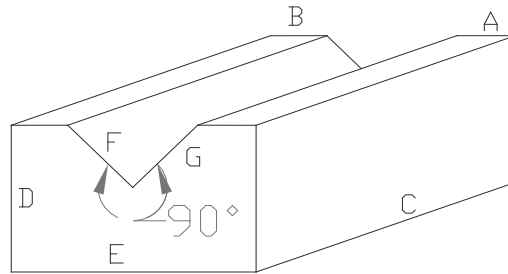

Q10.1

Carrying one decimal place, determine the gutter depth in feet using the following dimensions: A=B=1.8 ft, F=G=2.9 ft, C=8.6 ft, D= 4.8 ft and E=7.7 ft.

Q10.2

Using the dimensions from Q10.1, what is the volume in yd^3 of the structure?

Solutions to Problems 1.1-10.2

Q1.1

For the rectangle shown, what is the perimeter in yards if A=1 mile and B=126,720 inches?

| | |
|--|---|
| <i>Step 1. Determine what is being sought. In this problem, a perimeter is to be</i> | “what is the perimeter <u>in yards</u> if?” |
|--|---|

| | |
|--|--|
| <i>determined in units of yards.</i> | |
| <i>Step 2. List the given or known information and convert these values into common units.</i> | A: 1 mile = 5280 feet/3 = 1760 yards B: 126,720 inches /36 inches = 3520 yards |
| <i>Step 3. Choose an equation that will allow you to solve the question posed in Step 1.</i> | Perimeter of a rectangle: $(2 \times L) + (2 \times W)$ |
| <i>Step 4. Evaluate the equation by filling in the known values.</i> | $P = (2 \times B) + (2 \times A)$ $P = (2 \times 3520 \text{ yd}) + (2 \times 1760 \text{ yd})$ |
| <i>Step 5. Since there are no unknown variables left in the equation, solve the equation.</i> | $P = 7040 \text{ yd} + 3520 \text{ yd}$ $P = 10,560 \text{ yards}$ |

Q1.2

What is the area of the rectangle in square feet if A=60 yards and B=300 feet?

| | |
|--|---|
| <i>Step 1. Determine what is being sought. In this problem, an area is to be determined in units of square feet.</i> | “What is the area of the rectangle in <u>square feet</u> ” |
| <i>Step 2. List the given or known information and convert these values into common units.</i> | A: 60 yards x 3 = 180 feet B: 300 feet |
| <i>Step 3. Choose an equation that will allow you to solve the question posed in Step 1.</i> | Area of a rectangle: $L \times W$ |
| <i>Step 4. Evaluate the equation by filling in the known values.</i> | $\text{Area} = L \times W$ $\text{Area} = B \times A$ |
| <i>Step 5. Since there are no unknown variables left in the equation, solve the equation.</i> | $\text{Area} = 300 \text{ ft} \times 180 \text{ ft}$ $\text{Area} = 54,000 \text{ ft}^2$ |

Q1.3

If the area of the rectangle is 14,000 yd² and the width at A= 210 feet, what is the length of side B in yards?

| | |
|---|---|
| <i>Step 1. Determine what is being sought.</i> | “the length of side B in yards” |
| <i>Step 2. List the given or known information and convert these values into common units.</i> | A: 210 ft / 3 = 70 yards B: Unknown Area = 14,000 square yards |
| <i>Step 3. Choose an equation that will allow you to solve the question posed in Step 1.</i> | Area of a rectangle: L x W |
| <i>Step 4. Evaluate the equation by filling in the known values and isolating the unknown value (get it on one side of the equal sign by its self). To isolate “B”, we must remove the x 70 yd. Since it is multiplied by “B”, we can divide each side by 70 to rearrange the equation into a simpler form.</i> | Area = L x W 14,000 yd ² = B x 70 yd $\frac{14,000 \text{ yd}^2}{70 \text{ yd}} = B \times \frac{70 \text{ yd}}{70 \text{ yd}}$ Remember that (70 ÷ 70 = 1) therefore, $\frac{14,000 \text{ yd}^2}{70 \text{ yd}} = B$ |
| <i>Step 5. Since the unknown variable has been isolated, solve the equation.</i> | 200 yards is the length of B |

Q1.4

If the area of the rectangle is 1,080 in² and the length A= 1 yard, what is the width of side B in feet?

| | |
|---|---|
| <i>Step 1. Determine what is being sought.</i> | “what is the width of side B in feet” |
| <i>Step 2. List the given or known information and convert these values into common units.</i> | A: 1yd x 3 =3ft B: Unknown Area = 1080 in ² ÷ 144 in ² = 7.5 ft ² |
| <i>Step 3. Choose an equation that will allow you to solve the question posed in Step 1.</i> | Area of a rectangle: L x W |
| <i>Step 4. Evaluate the equation by filling in the known values and isolating the unknown value (get it on one side of the equal sign by its self). To isolate “B”, we must remove the x 3 ft. Since it is multiplied by “B”, we can divide each side by 3 to rearrange the equation into a simpler form.</i> | Area = L x W 7.5 ft ² = B x 3 ft $\frac{7.5 \text{ ft}^2}{3 \text{ ft}} = B \times \frac{3 \text{ ft}}{3 \text{ ft}}$ Remember that (3 ÷ 3 = 1) therefore, $\frac{7.5 \text{ sqft}}{3 \text{ ft}} = B$ |
| <i>Step 5. Since the unknown variable has been isolated, solve the equation.</i> | 2.5 ft is the length of B |

Q2.1

If the diameter of circle A is 8 inches, what is the radius of circle A in inches? What is the circumference of circle A in inches?

| | |
|--|---|
| <i>Step 1. Determine what is being sought. In this problem, two lengths are to be determined in units of inches.</i> | “what is the radius of circle A in inches” “what is the circumference of circle A in inches” |
| <i>Step 2. List the given or known information and convert these values into common units.</i> | Diameter = 8” |
| <i>Step 3. Choose an equation that will allow you to solve the question posed in Step 1.</i> | Diameter of a circle: $2 \times \text{radius}$ ($D = 2R$) |
| <i>Step 4. Evaluate the equation by filling in the known values and isolating the unknown value (get it on one side of the equal sign by its self). To isolate “R”, we must remove the $\times 2$. Since it is multiplied by “2”, we can divide each side by 2 to rearrange the equation into a simpler form.</i> | $D = 2 \times R$ $R = \frac{D}{2} =$ |
| <i>Step 5. Since the unknown variable has been isolated, solve the equation.</i> | $R = \frac{8''}{2} = 4 \text{ inches}$ |
| <i>Step 6. Having found the radius, it is now possible to find the circumference. Choose the appropriate formula for determining circumference.</i> | Circumference of a circle: $2 \pi r$ |
| <i>Step 7. Evaluate the equation using the known radius.</i> | $C = 2 \pi \times 4''$ $C = 8 \pi = 25.1 \text{ inches}$ |

Q2.2

If the radius of circle A is 9 inches, what is the diameter in feet?

| | |
|--|--|
| <i>Step 1. Determine what is being sought. In this problem, a length needs to be found in units of feet.</i> | “what is the diameter in feet” |
| <i>Step 2. List the given or known information and convert these values into common units.</i> | Radius = 9” |
| <i>Step 3. Choose an equation that will allow you to solve the question posed in Step 1.</i> | Diameter of a circle: $2 \times \text{radius}$ $D = 2 \times R$ |
| <i>Step 4. Evaluate the equation by filling in the known values.</i> | $D = 2 \times 9'' = 18''$ |
| <i>Step 5. Convert from inches to feet.</i> | Diameter = $\frac{18''}{12''} = 1.5 \text{ feet}$ |

Q2.3

What is the area of a circle in square inches if the radius is 15 inches? What would the area be in square feet?

| | |
|--|--|
| <i>Step 1. Determine what is being sought.</i> | “the area of circle A in square inches & area in square feet” |
| <i>Step 2. List the given or known information.</i> | Radius = 15” |
| <i>Step 3. Choose an equation that will allow you to solve the question posed in Step 1.</i> | Area of a circle: πr^2 Diameter of a circle: 2 x radius |
| <i>Step 4. Evaluate the equation by filling in the known values.</i> | Area = $\pi \times (15\text{in})^2$ Area = $3.14 \times 225 \text{ in}^2$ Area = 706.5 in^2 (Answer to part one) |
| <i>Step 5. Convert from square inches to square feet. There are 144 sqin in 1sqft.</i> | $\frac{706.5\text{in}^2}{144\text{in}^2} = 4.9 \text{ ft}^2$ |

Q2.4

If the area of circle A is 4.9 yd^2 , what is the circle’s diameter in feet?

| | |
|--|--|
| <i>Step 1. Determine what is being sought. In this problem, a length needs to be found in units of feet.</i> | “what is the circle’s diameter in feet” |
| <i>Step 2. List the given or known information and convert these values into common units.</i> | Area = 4.9 yd^2 |
| <i>Step 3. Choose an equation that will allow you to solve the question posed in Step 1. Use the area equation to determine the radius of the circle.</i> | Area of a circle: πr^2 Diameter of a circle: 2 x radius |
| <i>Step 4. Since the area is known, the radius can be determined by setting the area divided by pi equal to the radius squared.</i> <i>By taking the square root (the inverse operation of squaring) of each side, squaring process is “reversed” and the radius is obtained.</i> | Area of a circle: πr^2 $4.9 \text{ yd}^2 = \pi r^2$ $r^2 = \frac{4.9\text{yd}^2}{\pi} = 1.6 \text{ yd}^2$ $r^2 = 1.6 \text{ yd}^2$ $\sqrt{r^2} = \sqrt{1.6\text{yd}^2}$ $r = 1.3 \text{ yd}$ |
| <i>Substitute the radius value in to the diameter equation.</i> | $D = 2 \times r$ $D = 2 \times 1.3\text{yd} = 2.6 \text{ yd}$ |
| <i>Step 5. Convert from yards to feet.</i> | $2.6 \text{ yd} \times \frac{3\text{ft}}{1\text{yd}} = 7.8 \text{ ft}$ |

Q2.5

If a circle has a circumference of 7.33 yards, what is its area in square feet?

| | |
|---|--|
| <i>Step 1. Determine what is being sought.</i> | “what is the area in square feet” |
| <i>Step 2. List the given or known information and convert these values into the desired units.</i> | $C = 7.33\text{yds} = 22\text{ft}$ |
| <i>Step 3. Use the circumference equation to determine the radius of the circle.</i> | Area of a circle: πr^2 Circumference = $2\pi r$ |
| <i>Step 4. Evaluate the circumference equation by filling in the known values.</i> <i>Substitute the radius value in to the area equation.</i> | $C = 2\pi r$ $22\text{ ft} = 2\pi r$ $r = \frac{22\text{ ft}}{2\pi}$ $r = 3.5\text{ ft}$ Area of a circle: πr^2 $A = \pi 3.5\text{ft}^2$ $A = 38.5\text{ ft}^2$ |

Q3.1

What is the area of the right triangle shown in square feet if leg B is 96 inches long and leg A is 5 yards long?

| | |
|--|--|
| <i>Step 1. Determine what is being sought.</i> | The area of the <u>right triangle</u> in square feet |
| <i>Step 2. List the given or known information and convert these values into common units.</i> | Length of A = $5\text{yd} = 15\text{ft}$ Length of B = $96\text{in} = 8\text{ft}$ |
| <i>Step 3. Choose an equation that can be used to solve for the area.</i> | Area of a triangle: $\frac{1}{2}$ base x height |
| <i>Step 4. Since the lengths of both legs are known, substitute these values into the area equation and solve.</i> | Area = $\frac{1}{2}$ base x height Area = $\frac{1}{2}$ (A x B) Area = $\frac{1}{2}$ (15ft x 8ft) Area = 60 ft^2 |

Q3.2

What is the height “B” of a right triangle in feet if leg A is 75 feet and hypotenuse C is 110 feet?

| | |
|--|---|
| <i>Step 1. Determine what is being sought. In this problem, a length needs to be found in units of feet.</i> | The height of the <u>right triangle</u> in feet. |
| <i>Step 2. List the given or known information and convert these values into common units.</i> | Length of A = 75ft Length of C = 110ft |
| <i>Step 3. Choose equations that will allow you to solve the question posed in Step 1. The Pythagorean theorem shown can always be used for finding the length of a right triangle’s leg if the other two lengths are known.</i> | To find the unknown length of a right triangle’s side: $A^2+B^2=C^2$ |
| <i>Step 4. Rearrange the Pythagorean theorem for right triangles ($A^2+B^2=C^2$) to determine the length of side B. This begins by isolating the unknown variable “B” on one side of the equation and all known values on the opposite side of the = sign. To remove the squared operation, follow the steps given in Solution Q2.4 step 4.</i> | $A^2+B^2=C^2$ $B^2 = C^2 - A^2$ $B^2 = (110 \text{ ft})^2 - (75 \text{ ft})^2$ $B^2 = 12,100 \text{ ft}^2 - 5,625 \text{ ft}^2$ $B^2 = 6,475 \text{ ft}^2$ $\sqrt{B^2} = \sqrt{6,475 \text{ ft}^2}$ $B = 80.5 \text{ ft}$ |

Q3.3

What is the length of leg A in feet (to one decimal place), if leg B is 5 feet and C is 7.1 feet? What is the triangle's area in square feet?

| | |
|--|--|
| <p><i>Step 1. Determine what is being sought. Notice that this is a two part problem.</i></p> | <p>1st The length of side A in feet to 1 D.P. 2nd The area of the <u>right triangle</u> in ft².</p> |
| <p><i>Step 2. List the given or known information and convert these values into common units.</i></p> | <p>Length of B = 5ft Length of C = 7.1ft</p> |
| <p><i>Step 3. Choose equations that will allow you to solve the question(s) posed in Step 1.</i></p> | <p>To find the unknown length of a right triangle's side: $A^2+B^2=C^2$ Area of a triangle: $\frac{1}{2}$ base x height</p> |
| <p><i>Step 4. First, rearrange the Pythagorean theorem for right triangles ($A^2+B^2=C^2$) to isolate unknown value A^2.</i></p> <p><i>Determine the length of side A by employing the inverse relationship between a number's square and its square root as discussed earlier.</i></p> <p><i>Now that the length of side A is known, determine the triangle's area.</i></p> | <p>$A^2+B^2=C^2$ $A^2 = C^2 - B^2$ $A^2 = (7.1 \text{ ft})^2 - (5 \text{ ft})^2$ $A^2 = 50.4 \text{ ft}^2 - 25 \text{ ft}^2$ $A^2 = 25.4 \text{ ft}^2$ $\sqrt{A^2} = \sqrt{25.4 \text{ ft}^2}$ "A" = 5.0 ft Area = $\frac{1}{2}$ base x height Area = $\frac{1}{2}$ (A x B) Area = $\frac{1}{2}$ (5ft x 5ft) Area = 12.5 ft²</p> |

Q3.4

For the right triangle shown, what is the area in square feet if A=8' and C=10'? What is the area in square yards?

| | |
|--|---|
| <p><i>Step 1. Determine what is being sought.</i></p> | <p>The area of the <u>right triangle</u> in square feet</p> |
| <p><i>Step 2. List the given or known information and convert these values into common units.</i></p> | <p>Length of A = 8ft Length of C = 10ft</p> |
| <p><i>Step 3. Choose equations that will allow you to solve the question posed in Step 1.</i></p> | <p>To find the unknown length of a right triangle's side: $A^2+B^2=C^2$ Area of a triangle: $\frac{1}{2}$ base x height</p> |
| <p><i>Step 4. First, rearrange the Pythagorean theorem for right triangles ($A^2+B^2=C^2$) to determine the length of side B.</i></p> <p>Now that the length of side B is known, determine the triangle's area.</p> <p>Convert from ft^2 to yd^2.</p> | <p>$A^2+B^2=C^2$ $B^2 = C^2 - A^2$ $B^2 = (10 \text{ ft})^2 - (8 \text{ ft})^2$ $B^2 = 100 \text{ ft}^2 - 64 \text{ ft}^2$ $B^2 = 36\text{ft}^2$ $\sqrt{B^2} = \sqrt{36\text{ft}^2}$ $B = 6 \text{ ft}$</p> <p>Area = $\frac{1}{2}$ base x height Area = $\frac{1}{2}$ (A x B) Area = $\frac{1}{2}$ (8ft x 6ft) Area = 24 ft^2 Area = $\frac{24}{9} = 2.7 \text{ yd}^2$</p> |

Q4.1

For the cube shown, what is the volume (to one decimal place) in cubic yards if A=6ft, B=8ft and C=2yd?

| | |
|--|--|
| <i>Step 1. Determine what is being sought. Take note that the answer is to be reported to its nearest tenth.</i> | “What is the volume in cubic yards?” |
| <i>Step 2. List the given or known information and convert these values into common units.</i> | A= 6 ft B= 8 ft C= 2 yd = 6ft |
| <i>Step 3. Choose an equation that will allow you to solve the question posed in Step 1.</i> | Volume of a cube = L x W x H |
| <i>Step 4. Evaluate the equation by filling in the known values.</i> | Vol = 6ft x 8ft x 6ft Vol = 288 ft ³ |
| <i>Step 5. Convert the answer into the correct units. There are 27ft³ in 1yd³ so dividing the ft³ by 27 will convert the answer into cubic yards.</i> | $\frac{288 \text{ ft}^3}{27 \text{ ft}^3} = 10.7 \text{ yd}^3$ |

Q4.2

If the cube shown has a density of 150 lbs/cubic foot, use the volume determined in Q4.1 to determine the solid’s weight.

| | |
|---|--|
| <i>Step 1. Determine what is being sought.</i> | “Determine the solid’s weight?” |
| <i>Step 2. List the given or known information. Convert these values into common units (Notice that the volume in cubic feet was determined in the course of solving Q4.1)</i> | Density = $\frac{\text{weight}}{\text{volume}} = 150 \text{ lbs/ft}^3$ Vol = 288 ft ³ |
| <i>Step 3. Choose an equation that will allow you to solve the question posed in Step 1. Rearrange the equation to isolate the unknown quantity. Since both the volume and density are given, they will be opposite the weight variable. To rearrange the Eqn. each side is multiplied by the volume component thereby canceling out this component on the right side of the Eqn.</i> | Density = $\frac{\text{weight}}{\text{volume}}$ Volume x Density = $\frac{\text{weight}}{\text{volume}} \times \text{Volume}$ Volume x Density = Weight |
| <i>Step 4. Evaluate the equation by filling in the known values. Note that by having ft³ in the numerator and the denominator, they cancel one another.</i> | Weight = Vol x Den Weight = 288 ft ³ x 150 lbs/ft ³ Weight = 43,200 $\frac{\text{ft}^3 \cdot \text{lbs}}{\text{ft}^3}$ Weight = 43,200 pounds |

Q4.3

If a cubic structure weighs 2.2 tons and has a density of 200 lbs/cubic foot, what is the length of side “C” in inches if side “B” is 6 feet and side “A” is 30 inches?

| | |
|---|--|
| <p><i>Step 1. Determine what is being sought.</i></p> | <p>“Determine the length of side C in inches”</p> |
| <p><i>Step 2. List the given or known information. Convert these values into common units. In this problem we need feet and lbs.</i></p> | <p>Total weight = 2.2 Tons = 4,400 lbs Density = 200 lbs/cubic foot A = 30 inches = 2.5 ft B = 6 ft</p> |
| <p><i>Step 3. Choose equations that will allow you to solve the question posed in Step 1. Since a Wt. and a Den. are given, a volume can be determined. Once the volume is known, it can be used along with the given lengths of sides A and B to determine length C.</i></p> | <p>Density = $\frac{\text{weight}}{\text{volume}}$ Volume = L x W x H</p> |
| <p><i>Step 4. Rearrange the density equation to determine the cube’s volume.</i></p> <p><i>Solve for length C (in feet).</i></p> | <p>density = $\frac{\text{weight}}{\text{volume}}$ volume = $\frac{\text{weight}}{\text{density}}$ volume = $\frac{4400\text{lbs}}{200\text{lbs} / \text{ft}^3}$ volume = 22 ft³</p> <p>Volume = L x W x H 22 ft³ = A x B x C 22 ft³ = 2.5 ft x 6 ft x C $C = \frac{22\text{ft}^3}{(2.5\text{ft} \times 6\text{ft})} = 1.47 \text{ ft}$</p> |
| <p><i>Step 5. Convert the answer into the correct units. Since there are 12 inches in a foot, multiplying the length in feet by 12 will convert the answer into inches.</i></p> | <p>C = 1.42 ft x 12 = 17.6 inches</p> |

Q5.1

What is the volume of the figure shown (in ft³) if lengths C=F=G=1 ft, D=6 inches and E=2 ft?

| | |
|--|--|
| <i>Step 1. Determine what is being sought.</i> | “What is the volume of the figure in cubic feet” |
| <i>Step 2. List the given or known information and convert these values into common units.</i> | Side C = F = G = 1 ft Side D = 6 in. = 0.5 ft Side E = 2 ft |
| <i>Step 3. Design equations that will allow you to determine the lengths of A and B.</i> | A = E + D A = 2 ft + .5 ft = 2.5 ft B = F + G B = 1 ft + 1 ft = 2 ft |
| <i>Step 4. Now that all dimensions are known, determine the volume of this figure by visualizing it as two cubes. Use either CDG and ACF <u>OR</u> use BCD and CEF</i> | Solve the volume equations for both cubes. <i>(I chose to use CDG and ACF)</i> Vol CDG: Vol ACF: LxWxH = CxDxG LxWxH = AxCxH = 1 x 0.5 x 1 = 2.5 x 1 x 1 = 0.5 ft ³ = 2.5 ft ³ |
| <i>Step 5. Since there are no unknown variables left in the equation, solve the equation.</i> | Solve for the total volume of the figure: 0.5 ft ³ + 2.5 ft ³ = 3 ft ³ |

Q5.2

Using the volume calculated in Q5.1, what is the density of this structure if it weighs 175 pounds?

| | |
|---|---|
| <i>Step 1. Determine what is being sought</i> | “If this structure weighs 175 lbs., what is the material’s density in lbs/ft ³ ” |
| <i>Step 2. List the given or known information. Since the Wt. is already in pounds and the volume is in ft³, there are not additional conversions.</i> | Weight = 175 lbs. Volume = 3.0ft ³ |
| <i>Step 3. Choose an equation that will allow you to solve the question posed in Step 1.</i> | Density = $\frac{weight}{volume}$ |
| <i>Step 4. Evaluate the equation by filling in the known values.</i> | $D = \frac{175lbs}{3.0ft} = 58.3 \text{ lbs/ft}^3$ |

Q6.1

What is the length of side D in inches if $A=1\text{ yd}$, $B=1.5\text{ yd}$, $C=5\text{ ft}$ and $E=F=J=18\text{ inches}$?

| | |
|--|---|
| <i>Step 1. Determine what is being sought.</i> | “What is the length of side D in inches?” |
| <i>Step 2. List the given or known information and convert these values into common units.</i> | $A = 1\text{ yd} = 3\text{ ft}$ $B = 1.5\text{ yd} = 4.5\text{ ft}$ $C = 5\text{ ft}$ $J = F = E = 18\text{ in} = 1.5\text{ ft}$ |
| <i>Step 3. Design an equation that will allow you to determine the length of D.</i> | $D = B - J$ $D = 4.5 - 1.5 = 3\text{ ft}$ |
| <i>Step 4. Convert from feet to inches.</i> | $D = 3\text{ ft} = 36\text{ inches}$ |

Q6.2

What is the length of side G in inches using the lengths given in Q6.1?

| | |
|--|---|
| <i>Step 1. Determine what is being sought.</i> | “What is the length of side G in inches?” |
| <i>Step 2. List the given or known information and convert these values into common units.</i> | $A = 1\text{ yd} = 3\text{ ft}$ $B = 1.5\text{ yd} = 4.5\text{ ft}$ $C = 5\text{ ft}$ $J = F = E = 18\text{ in} = 1.5$ |
| <i>Step 3. Design an equation that will allow you to determine the length of G.</i> | $G = A - E$ $G = 3 - 1.5 = 1.5\text{ ft}$ |
| <i>Step 4. Convert from feet to inches.</i> | $G = 1.5\text{ ft} = 18\text{ inches}$ |

Q6.3

What is the length of side H in inches using the lengths given in Q6.1?

| | |
|--|---|
| <i>Step 1. Determine what is being sought.</i> | “What is the length of side H in inches?” |
| <i>Step 2. List the given or known information and convert these values into common units.</i> | $A = 1\text{ yd} = 3\text{ ft}$ $B = 1.5\text{ yd} = 4.5\text{ ft}$ $C = 5\text{ ft}$ $J = F = E = 18\text{ in} = 1.5$ |
| <i>Step 3. Design an equation that will allow you to determine the length of H.</i> | $H = C - F$ $H = 5 - 1.5 = 3.5\text{ ft}$ |
| <i>Step 4. Convert from feet to inches.</i> | $H = 3.5\text{ ft} = 42\text{ inches}$ |

Q6.4

If cube ABC had a volume of 67.5 ft^3 prior to removing corner EFJ, how much does the structure weigh (in pounds) after removing corner EFJ given a density of 140 lbs/ft^3 ?

| | |
|---|--|
| <p><i>Step 1. Determine what is being sought. In this problem, a small weight must be subtracted from a larger weight.</i></p> | <p>“How much does the structure weigh after removing corner EFJ?”</p> |
| <p><i>Step 2. List the given or known information and convert these values into common units.</i></p> | <p>Volume of cube ABC = 67.5 ft^3 Length E=F=J= 18 in = 1.5 ft Density = 140 lbs/ft^3</p> |
| <p><i>Step 3. Identify the necessary equations. This problem will be solved in three steps. First, the volume of cube EFJ must be determined; second the volume of EFJ must be subtracted from the volume of ABC. Lastly, the weight of modified cube must be calculated using the density.</i></p> | <p>Vol. = L x W x H (Vol. = E x F x J)</p> $D = \frac{\text{Mass}}{\text{Volume}}$ $M = D \times V$ <p>Determine volume of removed corner EFJ: $V = 1.5 \text{ ft} \times 1.5 \text{ ft} \times 1.5 \text{ ft}$ $V = 3.375 \text{ ft}^3$ Determine M prior to removing corner $M = 140 \text{ lbs/ft}^3 \times 67.5 \text{ ft}^3 = 9450 \text{ lbs}$</p> |
| <p><i>Step 4. Evaluate the volume equation by filling in the known values.</i></p> <p><i>Determine the volume of the modified cube.</i></p> <p><i>Rearrange the density equation to determine the cube’s weight.</i></p> | <p>Vol. = L x W x H Vol. = E x F x J = $1.5 \times 1.5 \times 1.5$ Vol. = 3.375 ft^3</p> <p>Vol. (ABC) – Vol. (EFJ) $67.5 \text{ ft}^3 - 3.375 \text{ ft}^3 = \underline{64.125 \text{ ft}^3}$</p> $D = \frac{M}{V}$ $M = D \times V$ $M = \frac{140 \text{ lb}}{\text{ft}^3} \times 64.125 \text{ ft}^3 = 8,977.5 \text{ lbs}$ |

Q7.1

What is the length of cylinder AQ in feet if the area of circle Q is 1018 square inches and the volume of cylinder AQ is 146,592 in³?

| | |
|---|--|
| <i>Step 1. Determine what is being sought.</i> | “the length of cylinder AQ in feet” |
| <i>Step 2. List the given or known information. Since the area and volume are each given in inches, there is no need to convert to a new unit.</i> | Area of Q = 1,018 in ² Cylinder volume = 146,592 in ³ |
| <i>Step 3. Choose equations that will allow you to solve the question posed in Step 1. Note that the volume of a cylinder is obtained by multiplying the area of the base circle by the length of the cylinder.</i> | Area of a circle: πr^2 Volume of a cylinder: $\pi r^2 \times \text{length}$: (area x length) |
| <i>Step 4. Solve for cylinder length by rearranging the volume equation and substituting known values.</i> | Volume of a cylinder: $\pi r^2 \times \text{length}$ Vol. = area x length $\text{Length} = \frac{\text{volume}}{\text{area}} = \frac{146,592 \text{in}^3}{1,018 \text{in}^2}$ Length = 144 in |
| <i>Step 5. Convert the answer into the correct units.</i> | Length = $\frac{144 \text{in}}{12} = 12 \text{ ft}$ |

Q7.2

What is the radius of circle T in feet if the volume of cylinder BT is 904.8 ft³ and B is 96 inches tall?

| | |
|--|---|
| <i>Step 1. Determine what is being sought.</i> | “the radius of circle T in feet” |
| <i>Step 2. List the given or known information and convert these values into common units.</i> | Cylinder length “B” = 96 in = 8 ft Cylinder volume = 904.8 ft ³ |
| <i>Step 3. Choose equations that will allow you to solve the question posed in Step 1. Begin by determining the area of base circle “T”.</i> | Area of a circle: πr^2 Volume of a cylinder: $\pi r^2 \times \text{length}$: (area x length) |
| <i>Step 4. Solve for area by rearranging the volume equation and substituting known values.</i> | Volume of a cylinder: $\pi r^2 \times \text{length}$ Vol. = area x length $\text{Area} = \frac{\text{volume}}{\text{length}} = \frac{904.8 \text{ft}^3}{8 \text{ft}} = 113.1 \text{ft}^2$ |
| <i>Step 5. Using the area of Circle “T”, calculate the radius for the circle.</i> | Area of a circle: πr^2 $r^2 = \frac{\text{area}}{\pi} = \frac{113.1 \text{ft}^2}{3.14} = 36 \text{ft}^2$ $\sqrt{r^2} = \sqrt{36 \text{ft}^2} = 6 \text{ ft}$ |

Q7.3

Using the volumes from Q7.1 and Q7.2, determine the weight in pounds of the figure AQ~BT if the material density is 3800 lb/yd³.

| | |
|---|--|
| <i>Step 1. Identify what is being sought.</i> | “determine the weight in pounds of the figure AQ~BT” |
| <i>Step 2. List the given or known information and convert these values into common units. Division by 27 converts the density into units of lb/ft³. There are 1,728 cubic inches in a cubic foot.</i> | $\text{Density} = 3,800 \frac{\text{lb}}{\text{yd}^3} \times \frac{1 \text{yd}^3}{27 \text{ft}^3} = 140.7 \frac{\text{lb}}{\text{ft}^3}$ Vol. “AQ” = 146,592 in ³ / 1728 in ³ = 84.8 ft ³ Vol. “BT” = 904.8 ft ³ |
| <i>Step 3. Determine the total volume of the structure by summing the component volumes.</i> | Vol. Total = Vol. “AQ” + “BT” Vol. Total = 84.8 ft ³ + 904.8 ft ³ Vol. Total = 989.6 ft ³ |
| <i>Step 4. Solve for the cylinder weight by rearranging the density equation and substituting known values.</i> | $D = \frac{M}{V}$ $M = D \times V$ $M = \frac{140.7 \text{lb}}{\text{ft}^3} \times 989.6 \text{ft}^3 = 139,237 \text{ lbs}$ |

Q8.1

If “Circle Z” has a circumference of 300 inches, what is the diameter of circle Z to the nearest inch?

| | |
|--|---|
| <i>Step 1. Determine what is being sought.</i> | “What is the diameter of circle Z in inches?” |
| <i>Step 2. List the given or known information.</i> | Circumference = 300 in |
| <i>Step 3. Choose an equation that will allow you to solve the question posed in Step 1.</i> | Circumference = 2πr Diameter = 2 x r |
| <i>Step 4. Calculate the radius using the given circumference.</i> | $C = 2\pi r$ $r = \frac{C}{2\pi}$ $r = \frac{300}{2\pi}$ $r = 47.8 \text{ in}$ |
| <i>Step 5. Use the radius to obtain the diameter of the circle.</i> | $D = 2 \times r$ $D = 2 \times 47.8 \text{ in}$ $D = 95.6 \text{ in}$ Round to nearest inch ~ 96 inches |

Q8.2

If the ratio of lengths A:B:D is 1.5:2:1, and cylinder “DZ” has a volume of 50.24 ft^3 with a radius of 24 inches, then what lengths are cube sides “A” and “B”?

| | |
|--|---|
| <i>Step 1. Determine what is being sought.</i> | The key to this problem is obtaining the length of cylinder “DZ”. Using dimension D, A and B can be determined. |
| <i>Step 2. List the given or known information and convert these values into common units.</i> | Volume of cylinder DZ = 50.24 ft^3 Radius of circle D = 24 in = 2 ft |
| <i>Step 3. Choose an equation that will allow you to solve for the length of “D”.</i> | Volume = $\pi r^2 \times \text{Length}$, (L = Length of D) $50.24 \text{ ft}^3 = \pi (2\text{ft}^2)D$ $D = \frac{50.24 \text{ ft}^3}{\pi * 4 \text{ ft}^2}$ D = 4ft = Length of segment “D” |
| <i>Step 4. Evaluate the ratio.</i> | Ratio A : B : D = 1.5 : 2 : 1 Ratio A=1.5D : B=2D : D=1D |
| <i>Step 5. Now that length “D” is known to be 4ft, assign the ratios numeric value.</i> | Since D = 4 ft, A = 1.5D = 1.5 x 4 ft = 6 ft B = 2D = 2 x 4 ft = 8 ft |

Q9.1

For the structure shown, determine the surface area in square feet if A = 5.5in, B = 7.1in and D = 22in.

| | |
|--|--|
| <i>Step 1. Determine what is being sought.</i> | “determine the surface area in ft ² ” |
| <i>Step 2. List the given or known information and identify the missing information.</i> | A = 5.5 in B = 7.1 in C = ? D = 22 in |
| <i>Step 3. In order to calculate the area of rectangle “CD”, length C must first be determined. Recognize that “C” is the hypotenuse of a right triangle, therefore the Pythagorean theorem can be used since two of the three side lengths are known.</i> | $A^2 + B^2 = C^2$ $C^2 = A^2 + B^2$ $C = \sqrt{(A^2 + B^2)}$ $C = \sqrt{(5.5in^2 + 7.1in^2)}$ $C = \sqrt{(30.25in^2 + 50.41in^2)}$ $C = \sqrt{(80.66in^2)}$ C = 8.98 in = 9 inches |
| <i>Step 4. Now that all dimensions are known set up a surface area equation consisting of the area's for three rectangles and two triangles</i> | SA = Rect. AD + Rect. BD + Rect. CD + [2 x Triangle ABC] SA = AxD + BxD + CxD + [2 x ($\frac{1}{2}$ AxB)] SA = {(5.5 x 22) + (7.1 x 22) + (9 x 22) + [2 x ($\frac{1}{2}$ 5.5 x 7.1)]} in ² SA = {121 + 156.2 + 198 + 39.05} in ² SA = 514.25 in ² |
| <i>Step 5. Convert from square inches to square feet by dividing by 144.</i> | SA = $\frac{514.25in^2}{144in^2} = 3.6 ft^2$ |

Q9.2

Using the dimensions from Q9.1 determine the volume of this structure in gallons. One gallon contains 231in³.

| | |
|--|---|
| <i>Step 1. Determine what is being sought.</i> | “volume in gallons” |
| <i>Step 2. List the given or known information.</i> | A= 5.5in B= 7.1in D= 22in 1 Gallon = 231 in ³ |
| <i>Step 3. Use the triangular pyramid volume formula.</i> | Vol. Tri. Pyr. = $\frac{1}{2}$ base x height x length |
| <i>Step 4. Evaluate the equation by filling in the known values.</i> | Vol. = 0.5 x 5.5in x 7.1in x 22in Vol. = 429.6 in ³ |
| <i>Step 5. Convert the answer into the correct units. There are 231in³ in 1 gallon so division by 231 will convert the answer into gallons.</i> | $\frac{429.6in^3}{231in^3} = 1.9$ Gallons |

Q10.1

Carrying one decimal place, determine the vertical gutter depth (Q) in feet using the following dimensions: A=B=1.8 ft, F=G=2.9 ft, C=8.6 ft, D= 4.8 ft and E=7.7 ft.

| | |
|--|---|
| <i>Step 1. Determine what is being sought.</i> | “determine the vertical gutter depth (Q)” |
| <i>Step 2. List the given or known information.</i> | A=B=1.8 ft C=8.6 ft, D= 4.8 ft, E=7.7 ft F=G=2.9 ft |
| <i>Step 3. In order to calculate the vertical depth of the gutter, the width must first be determined.</i> <i>Visualize a vertical line rising from the gutter invert (bottom point) and intersecting the mid-point of the gutter width. The vertical bisecting line will divide the width in half, and form two identical right triangles.</i> | Gutter Width = E-A-B Width = 7.7 ft – 1.8 ft – 1.8 ft = 4.1 feet $\frac{\text{Width}}{2} = \frac{4.1 \text{ ft}}{2} = 2.05 \text{ ft (Label this Z)}$ |
| <i>Step 4. Substituting the lengths Z& F and the Pythagorean Theorem, the gutter depth (Q) can be calculated. Length F represents the hypotenuse of the triangle while Z and Q are legs.</i> | $A^2 + B^2 = C^2$ $Q^2 + Z^2 = F^2$ $Q^2 = F^2 - Z^2$ $Q = \sqrt{(F^2 - Z^2)}$ $Q = \sqrt{(2.9 \text{ ft}^2 - 2.05 \text{ ft}^2)}$ $Q = \sqrt{(8.4 \text{ ft}^2 - 4.2 \text{ ft}^2)}$ $Q = \sqrt{(4.2 \text{ ft}^2)}$ $Q = 2.05 \sim 2.0 \text{ ft}$ |

Q10.2

Using the dimensions from Q10.1, what is the volume in yd³ of the structure?

| | |
|---|--|
| <i>Step 1. Determine what is being sought.</i> | “volume of the structure in yd ³ ” |
| <i>Step 2. List the given or known information.</i> | C=8.6 ft ,D= 4.8 ft, E=7.7 ft F=G=2.9 ft |
| <i>Step 3. Set up an equation that represents the solid as two pieces, a cube with a triangular pyramid removed.</i> | Tot. Vol. = (Vol. Cube -Vol. Tri. Pyramid) Tot. Vol. = (CxExD) – {($\frac{1}{2}$ FxG) x C} |
| <i>Step 4. Evaluate the equation by filling in the known values.</i> | T.V.= {(8.6x7.7x4.8) – (.5x2.9x2.9x8.6)} ft ³ Tot. Vol. = 317.9 ft ³ – 36.2 ft ³ Total Volume = 281.7 ft ³ |
| <i>Step 5. Convert the answer into the correct units. There are 27ft³ in 1yd³ so division by 27 will convert the answer into gallons.</i> | $\frac{281.7 \text{ ft}^3}{27 \text{ ft}^3} = 10.4 \text{ yd}^3$ |